

TAG-Seq

Dhivya Arasappan

(Thanks for Some Slides from Misha Matz,
and Emily Tallman)

Whole RNA-Seq typically means small number of biological replicates

(A) RNA-seq publications by year in ecology and evolution

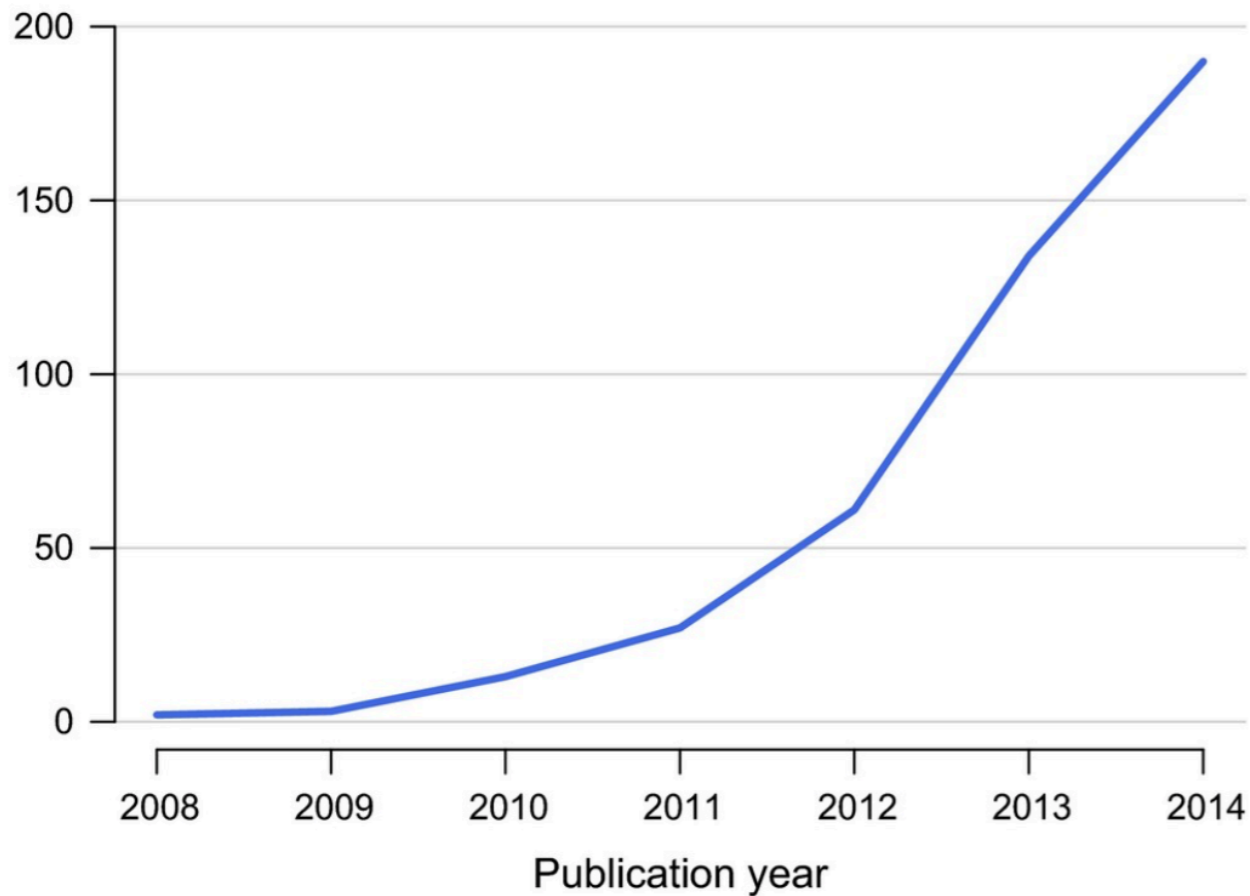

(B) Replicate usage by eco-evolutionary RNA-seq studies testing differential expression

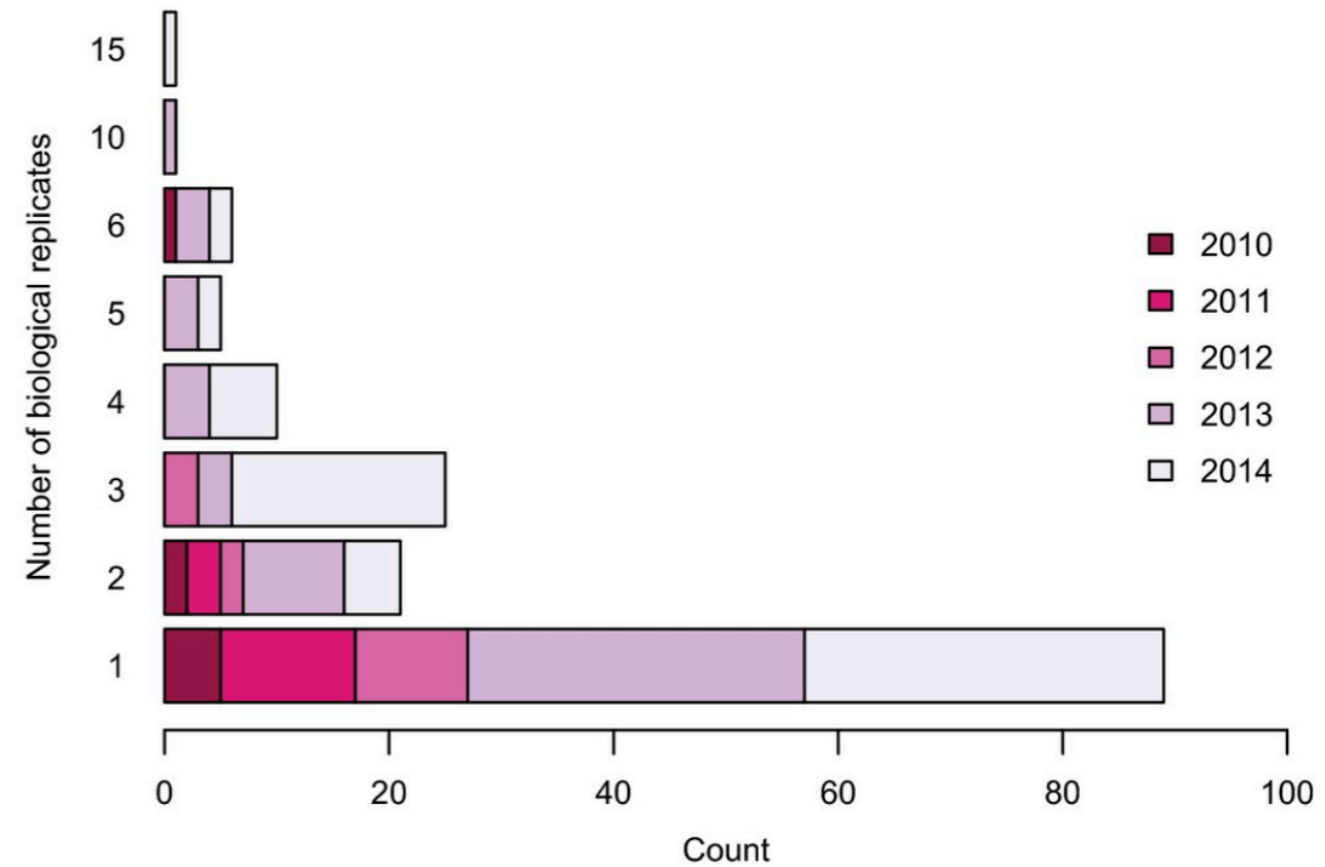

3' TAGSEQ- An Alternative to Whole RNA-Seq

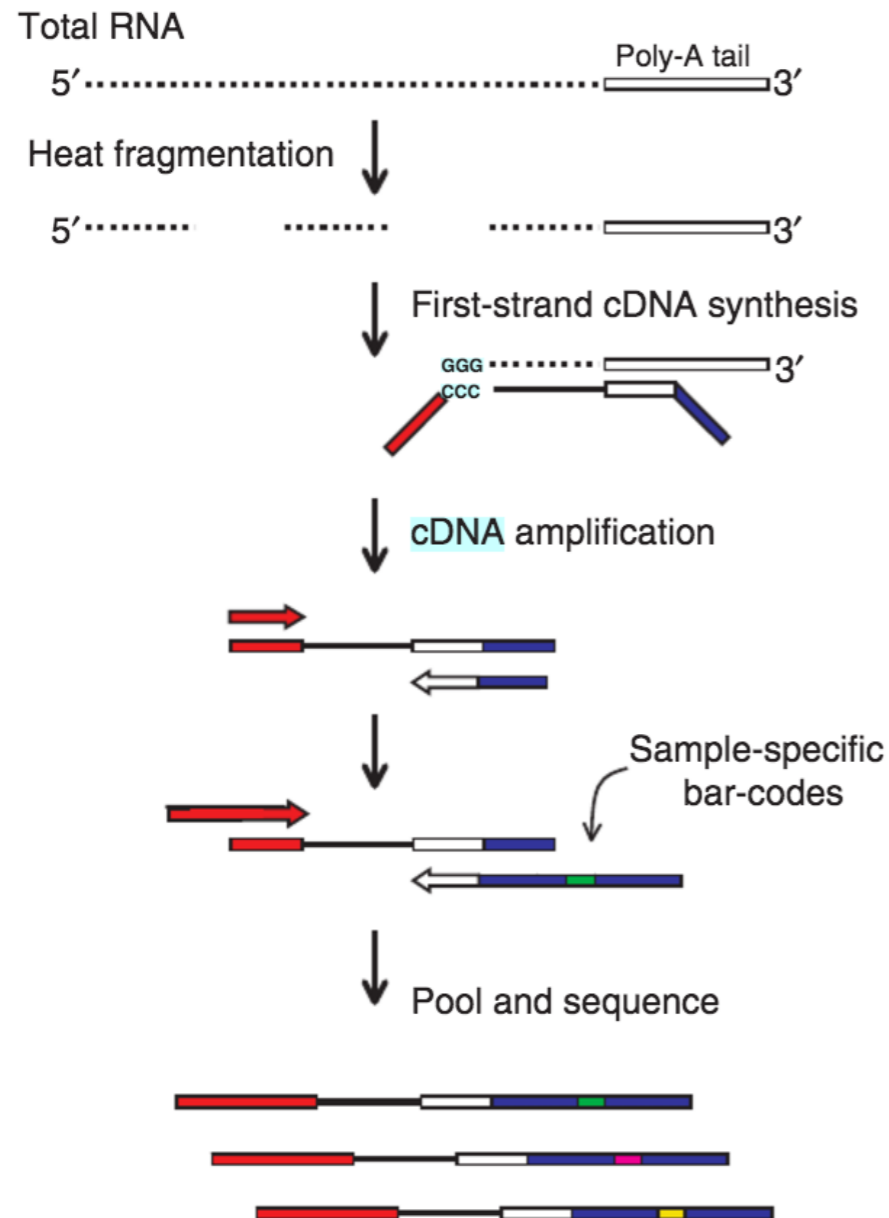

Targeting the 3' prime end of RNA

Fig. 1 Overview of the protocol used to prepare 3' cDNA tag libraries from total RNA. RNA was fragmented at the beginning to eliminate biases resulting from differences in transcript lengths. First-strand cDNA was primed with a modified oligo-dT containing primer to target 3' ends. Each sample was prepared with a sample-specific oligonucleotide barcode, then quantified and pooled prior to sequencing.

WHY TAGSEQ?

- Cheaper to sequence 3' end instead of the entire RNA.
 - Fewer reads need to be sequenced.
 - Lib prep is 10 times cheaper
- Amount of input RNA required is less.
- You can still identify differential expression.

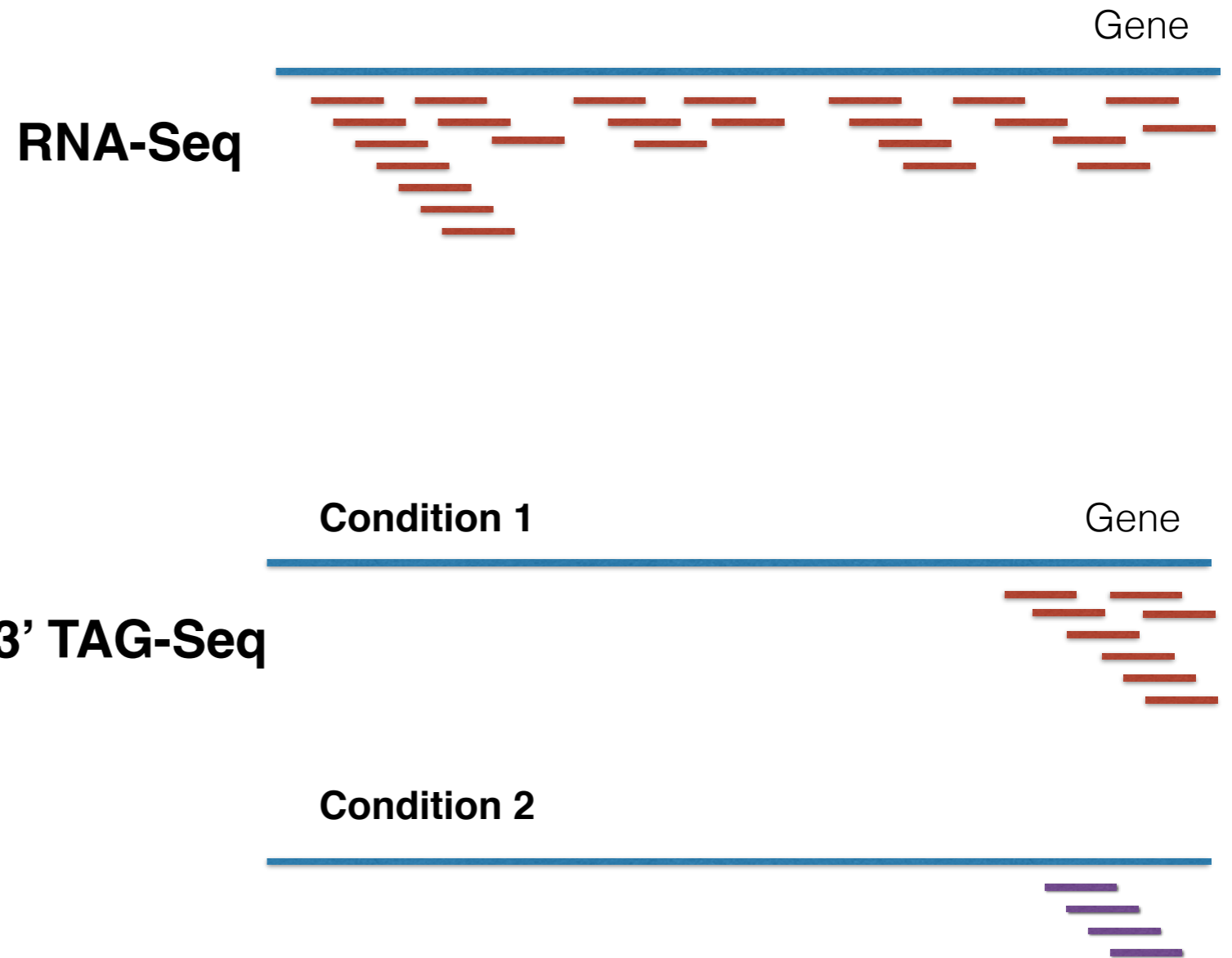

WHY NOT TAGSEQ?

- If you want to assemble a transcriptome
- If you want to look at differential splicing
- If you want to identify polymorphisms in gene sequences

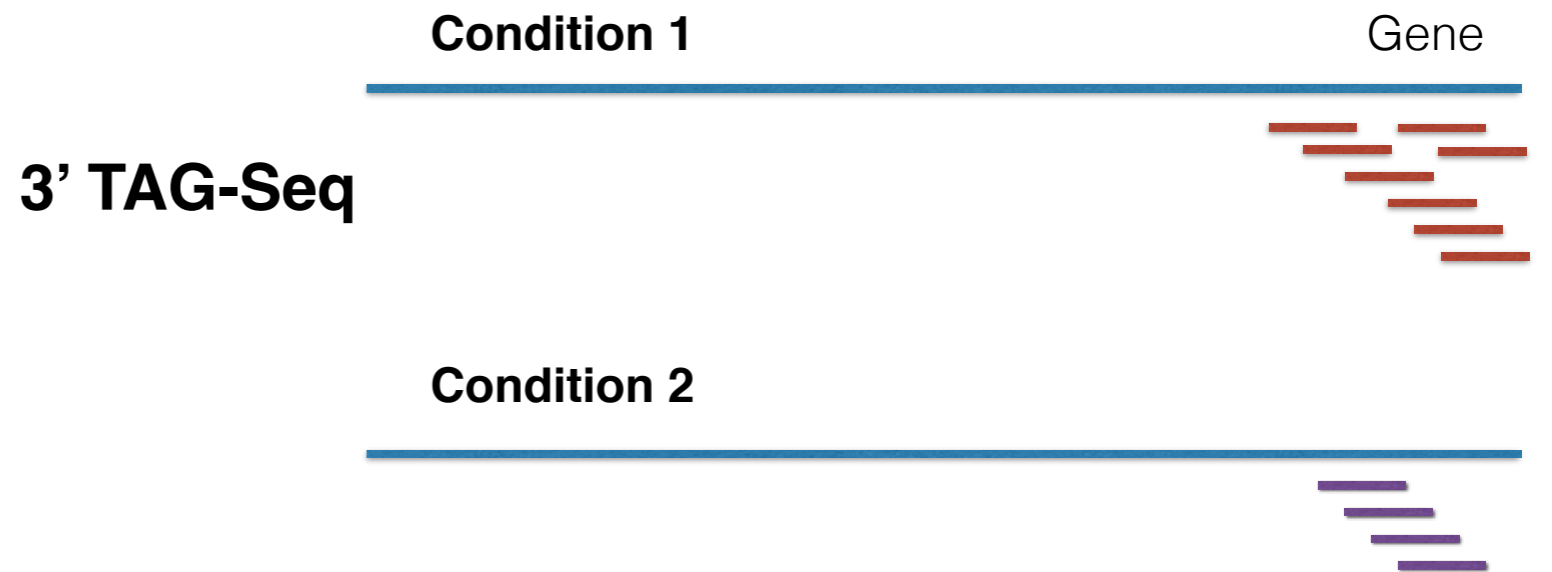
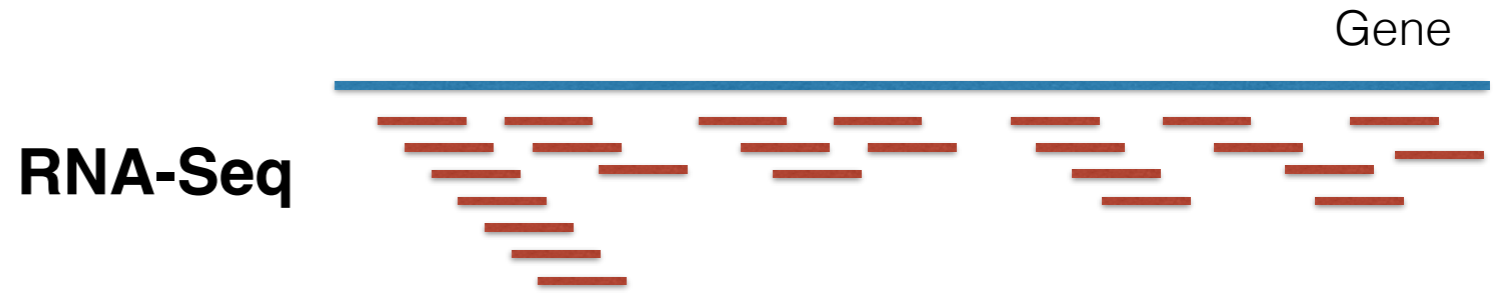

TAG-Seq Template Switching

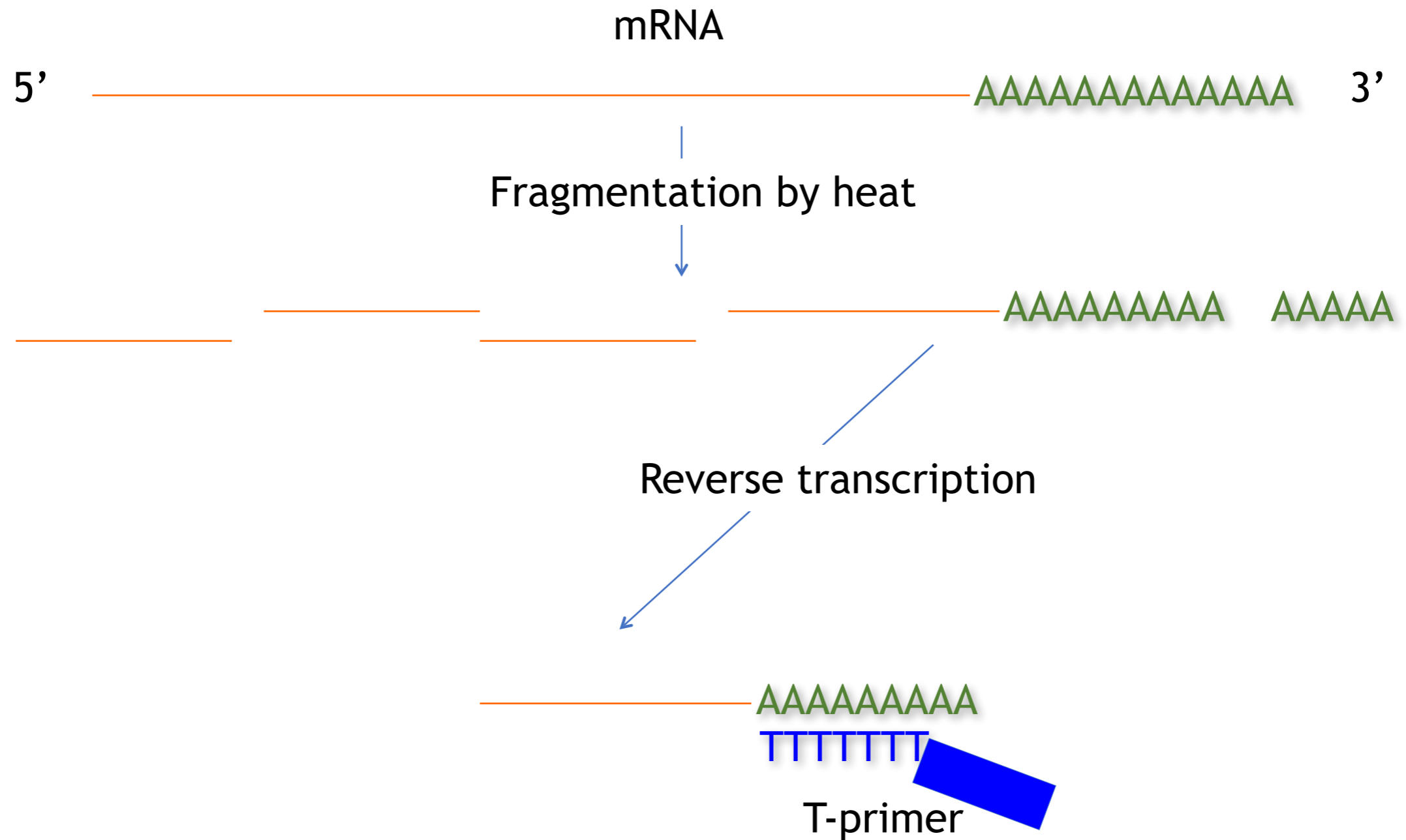

Tag-Seq Template Switching

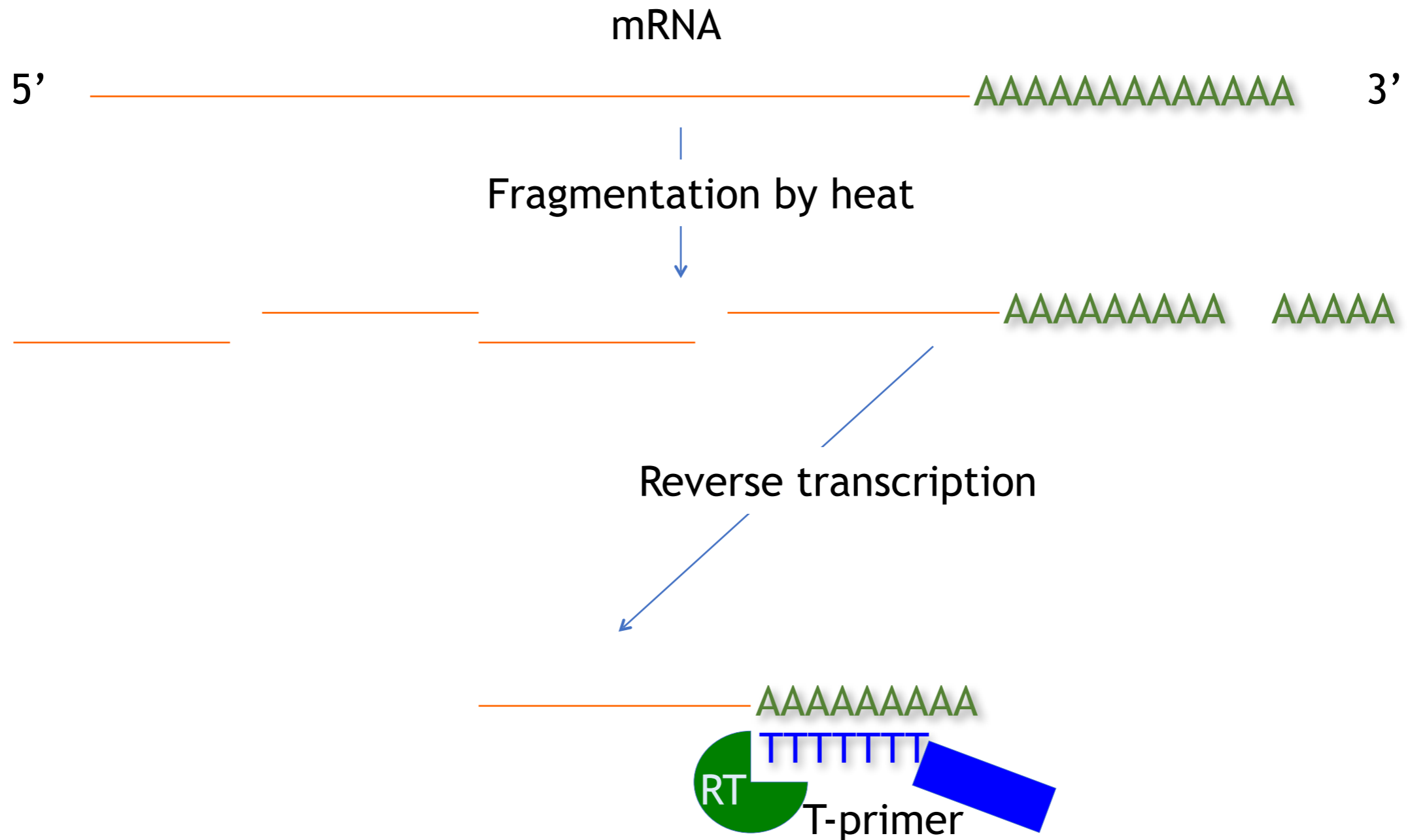

Tag-Seq Template Switching

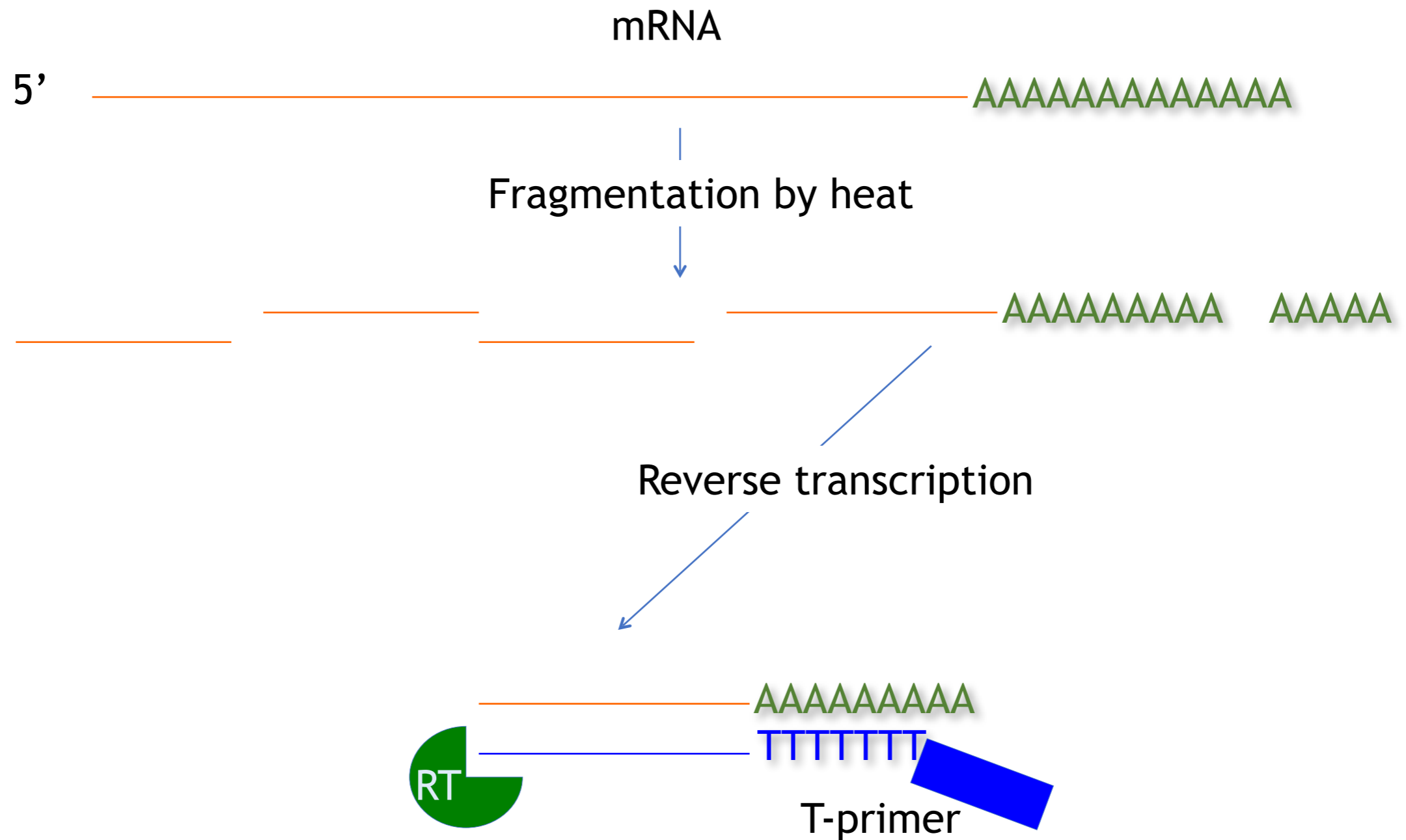

Tag-Seq Template Switching

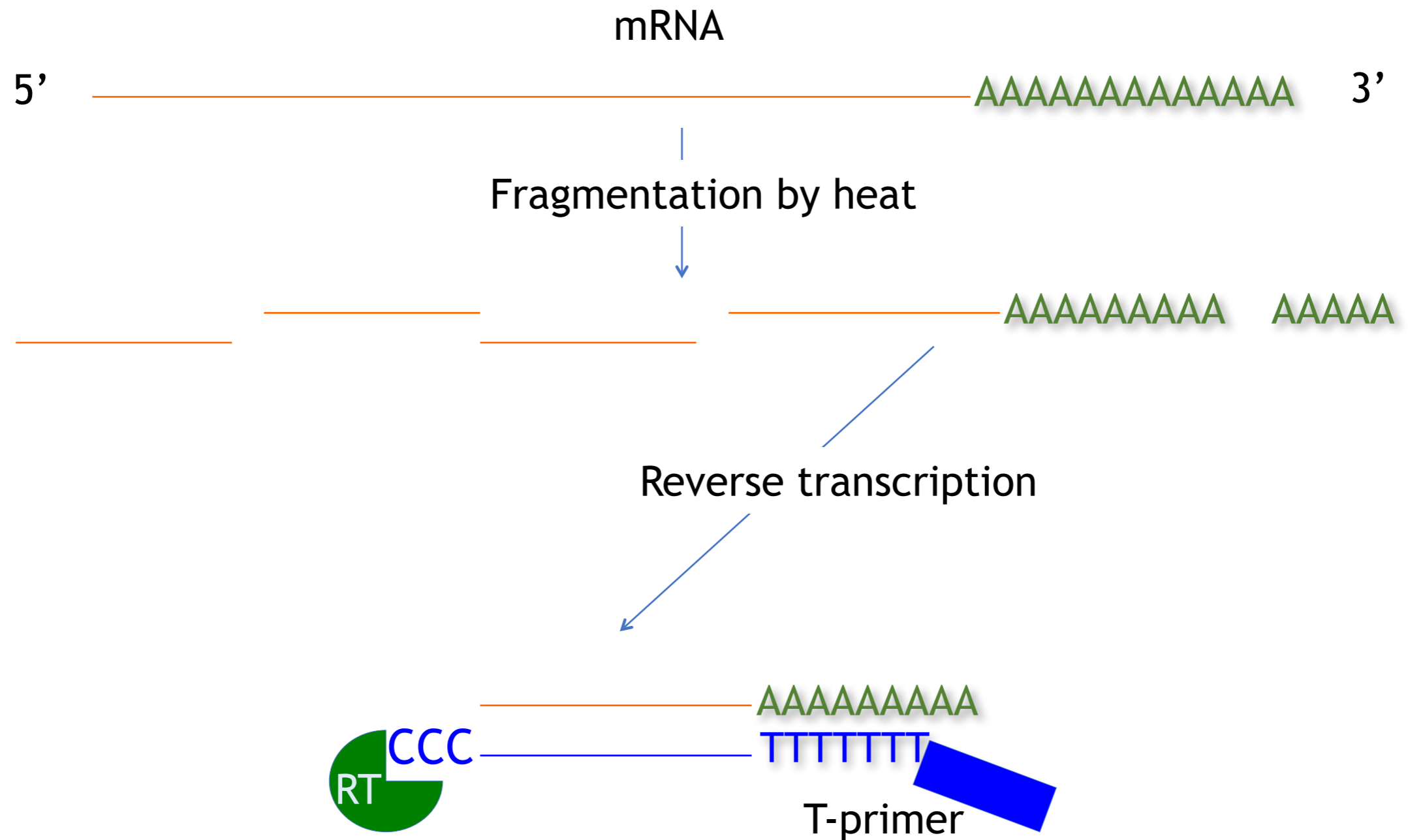

Tag-Seq Template Switching

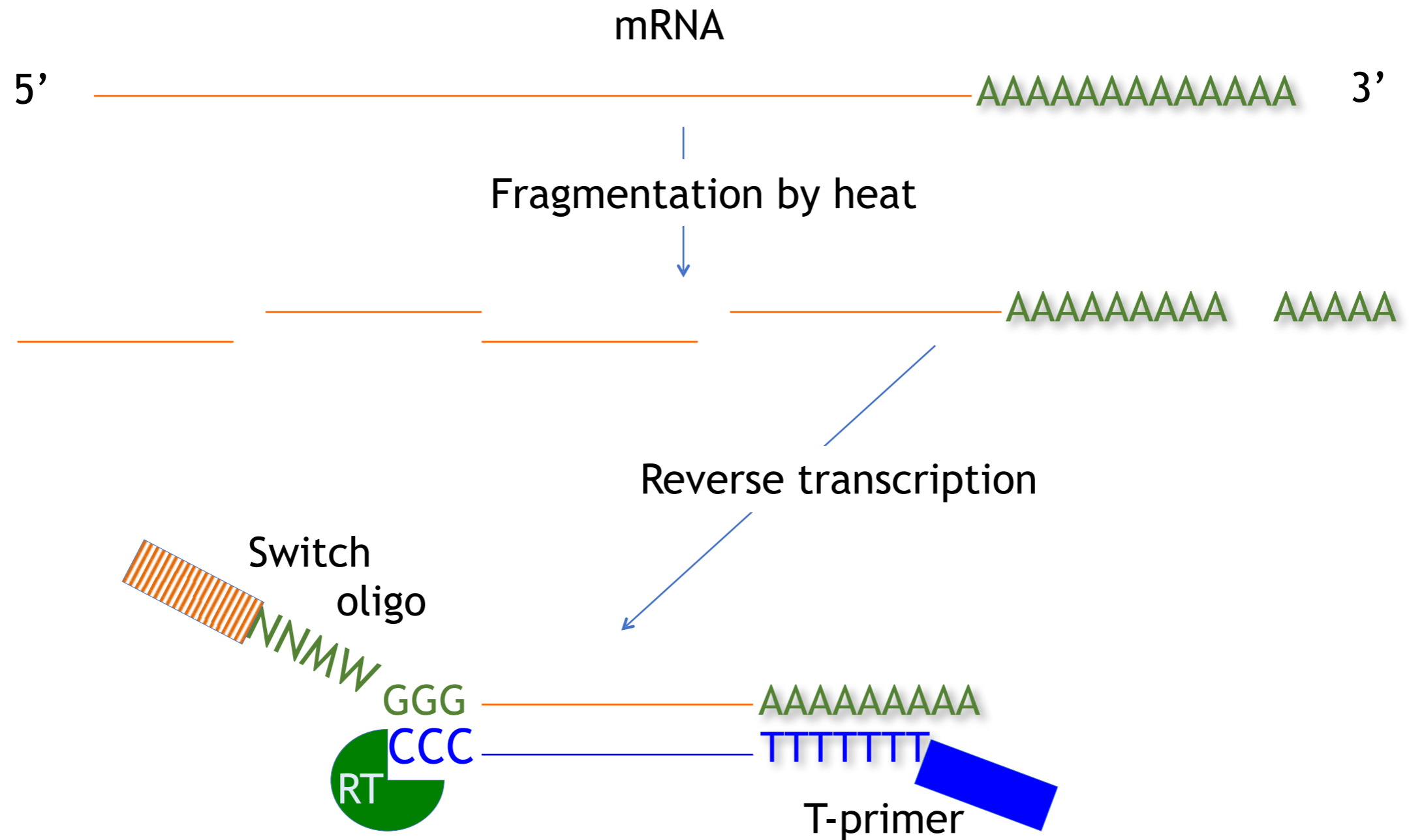

Tag-Seq Template Switching

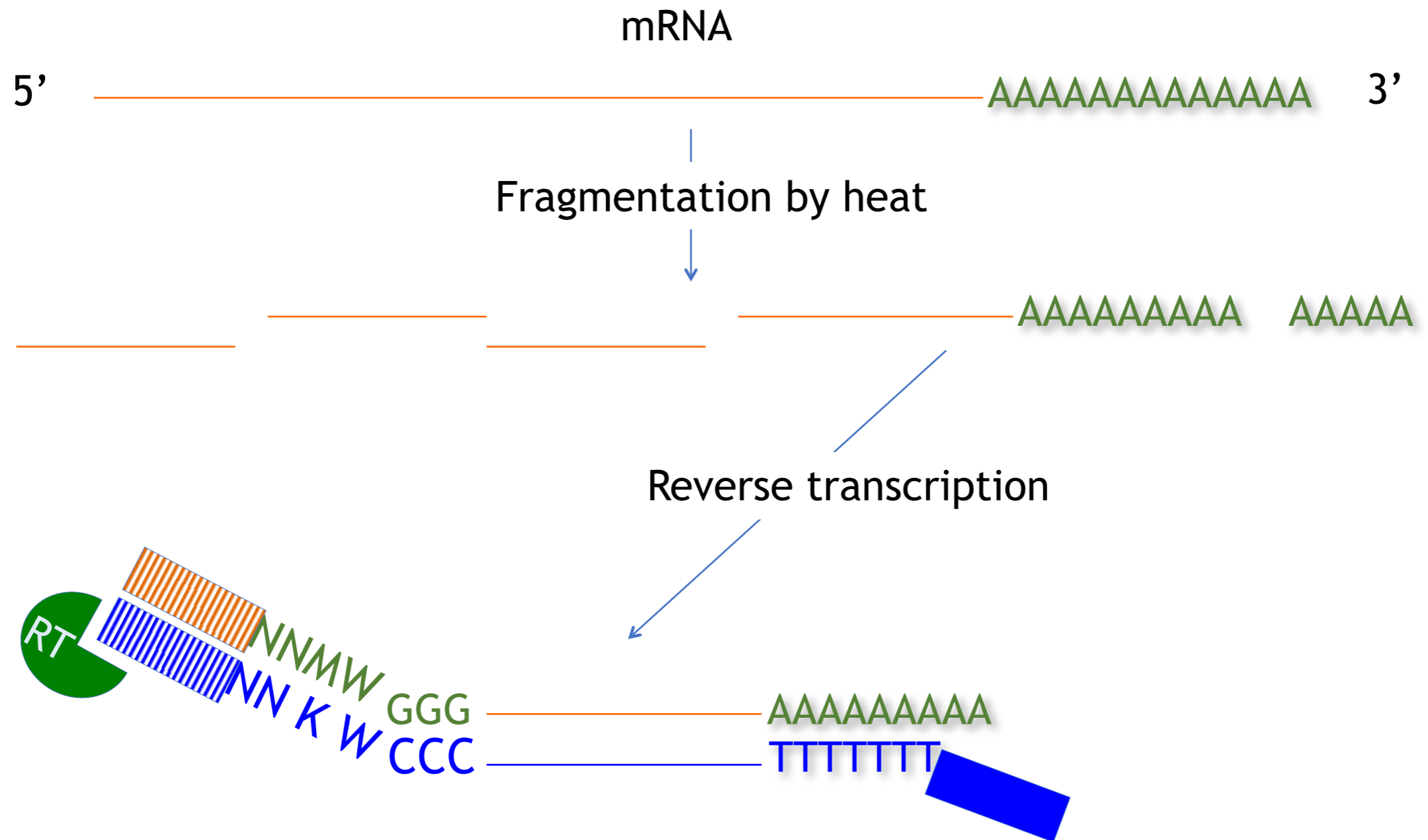

Tag-Seq Template Switching

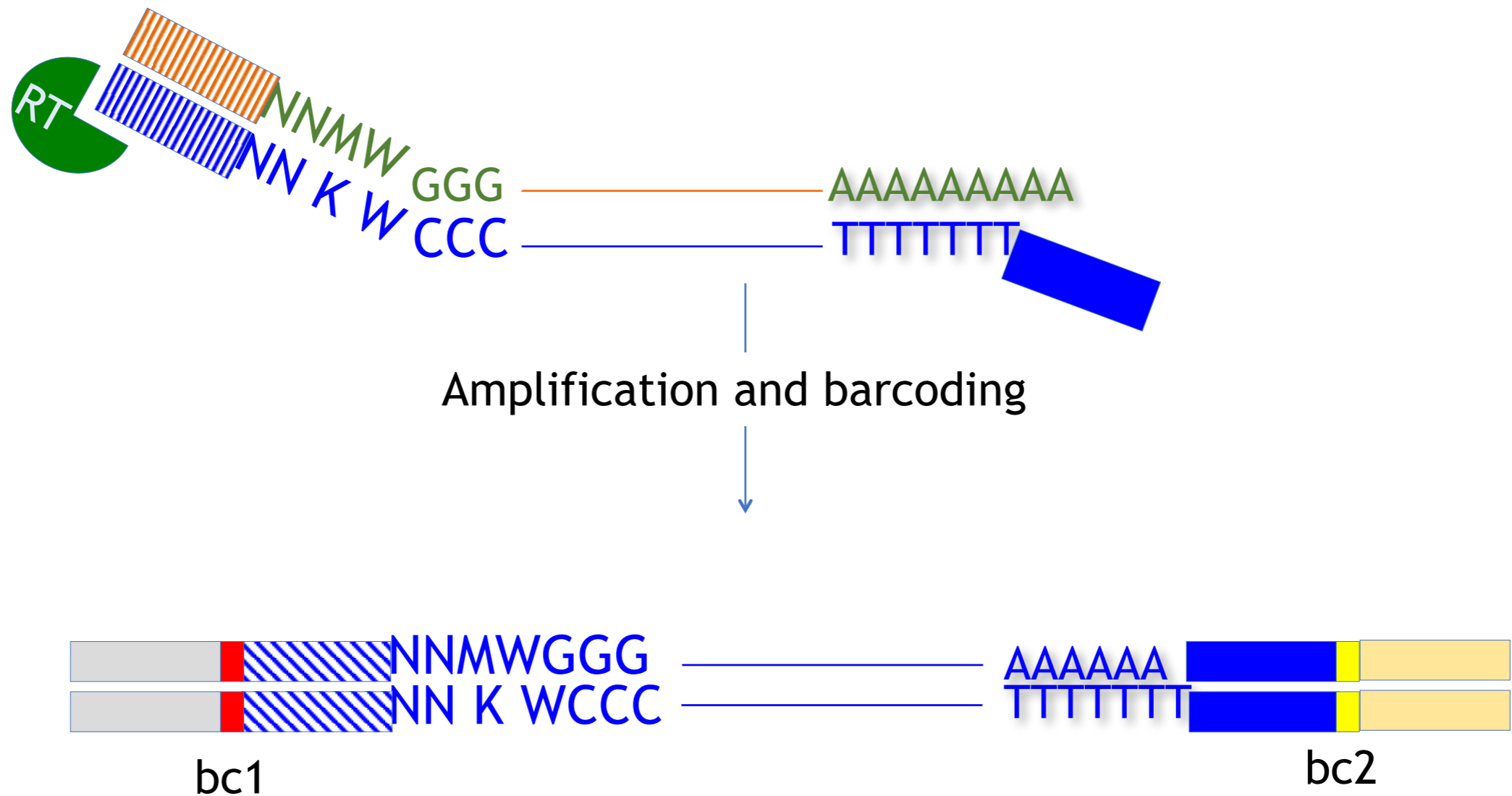

Tag-Seq Template Switching

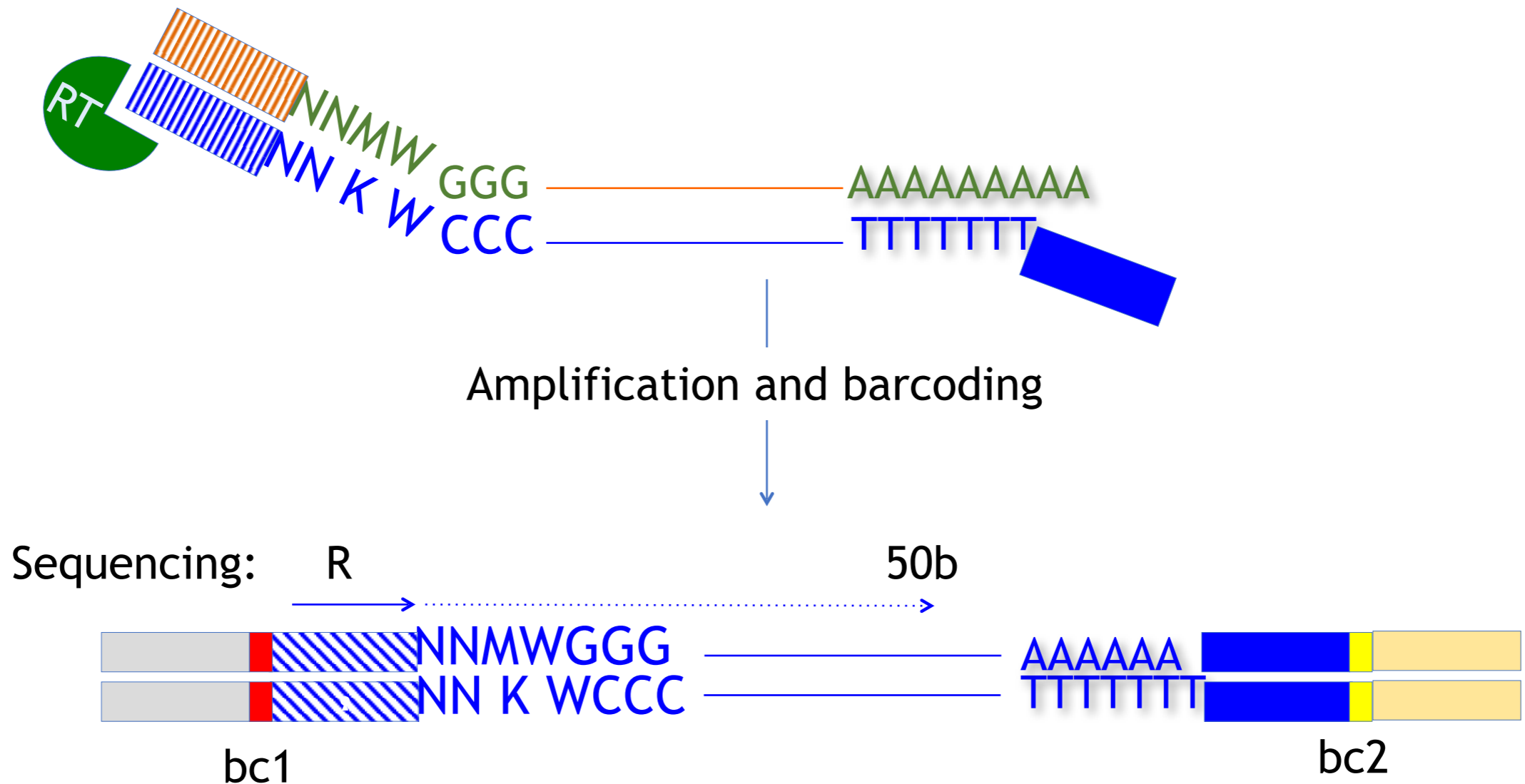

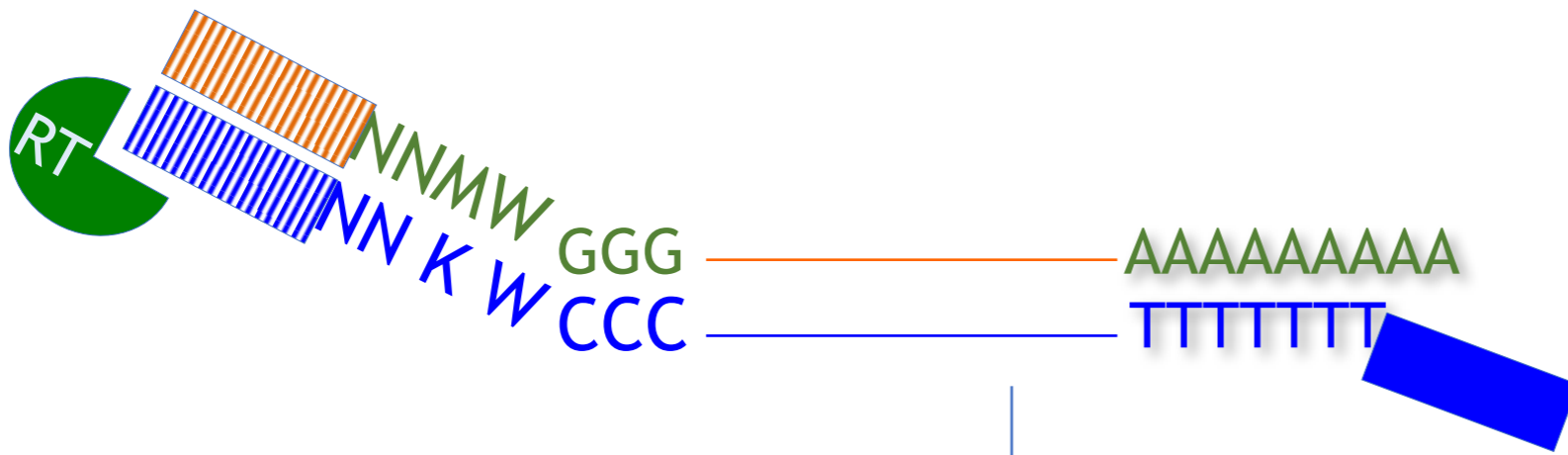

Amplification and barcoding

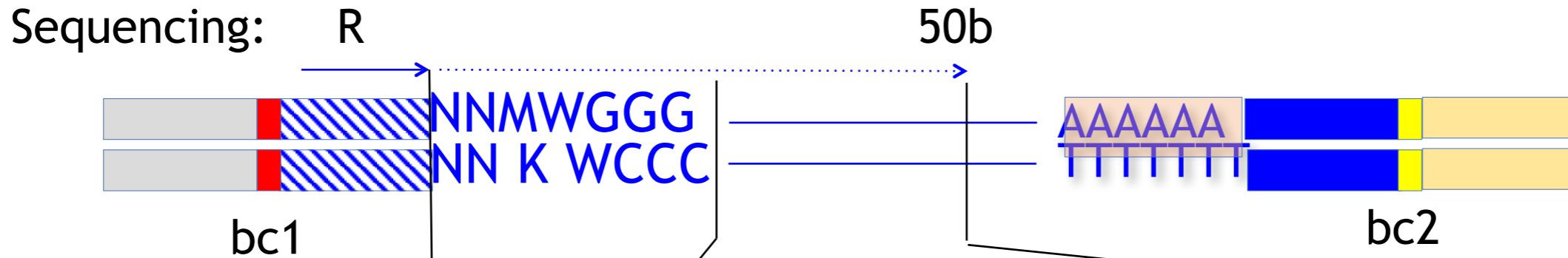

One tag per mRNA
 Unique:
 - NNMW (64-fold)+
 - First 20 bases (Frag point)

```

TCATGGGGAAAAAGCAATTGATAATGACAGCCTGGTGTTTTATTGGAAA
TACAGGGGGGAAAGATGTGAATTCATCAGAGTAGCACTTTATGTACTT
TCCTGGGGGAGACATAGAAAACAACACCTTTCATGCAAAAACAATGGGAA
ACCTGGGGGAGATATGCAGATGAGCATTGCTAACAGAATTACAAGATC
AGATGGGGACACCAGTGTCCCAGTGGATTGAACGACATCGATACGAAG
ATAAGGGGTATTTTAGCTTTGTGCTGGGACACTCAGTGACAGATATAAT
TACTGGGGTAGTTGCTTGGCTCTTGTTGCCGCTCCATGTCCATAGGATC
CCCAGGGGGAACAATATGGCAAAAAAAAAAAAAAAAAAAAAAAAAAAAAA
  
```

Is Tag-Seq Accurate?

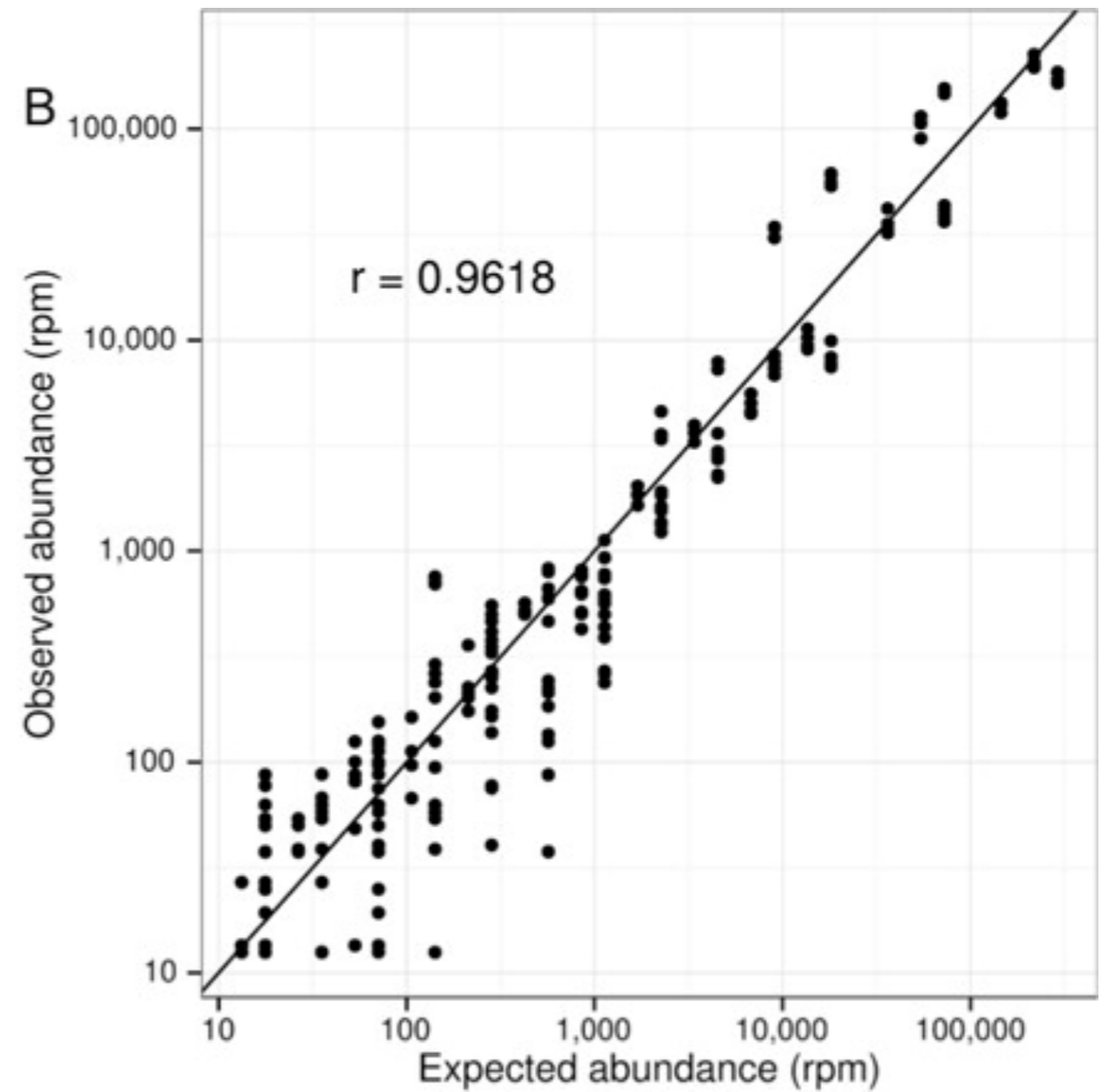
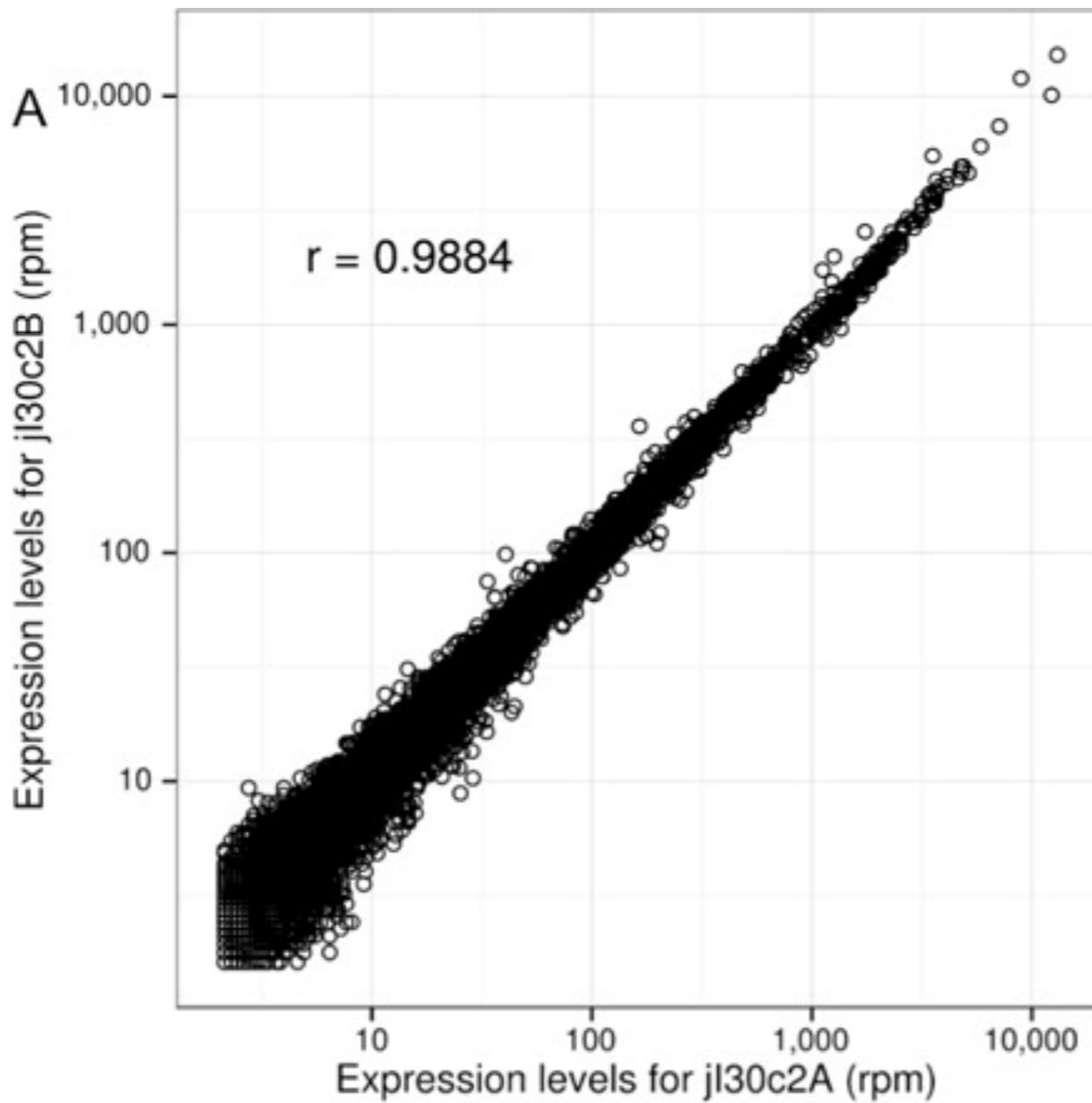

Is Tag-Seq comparable to whole RNA-Seq?

Tag-Seq recovers known concentrations of mRNA (ERCC controls) with more accuracy than whole mRNASeq

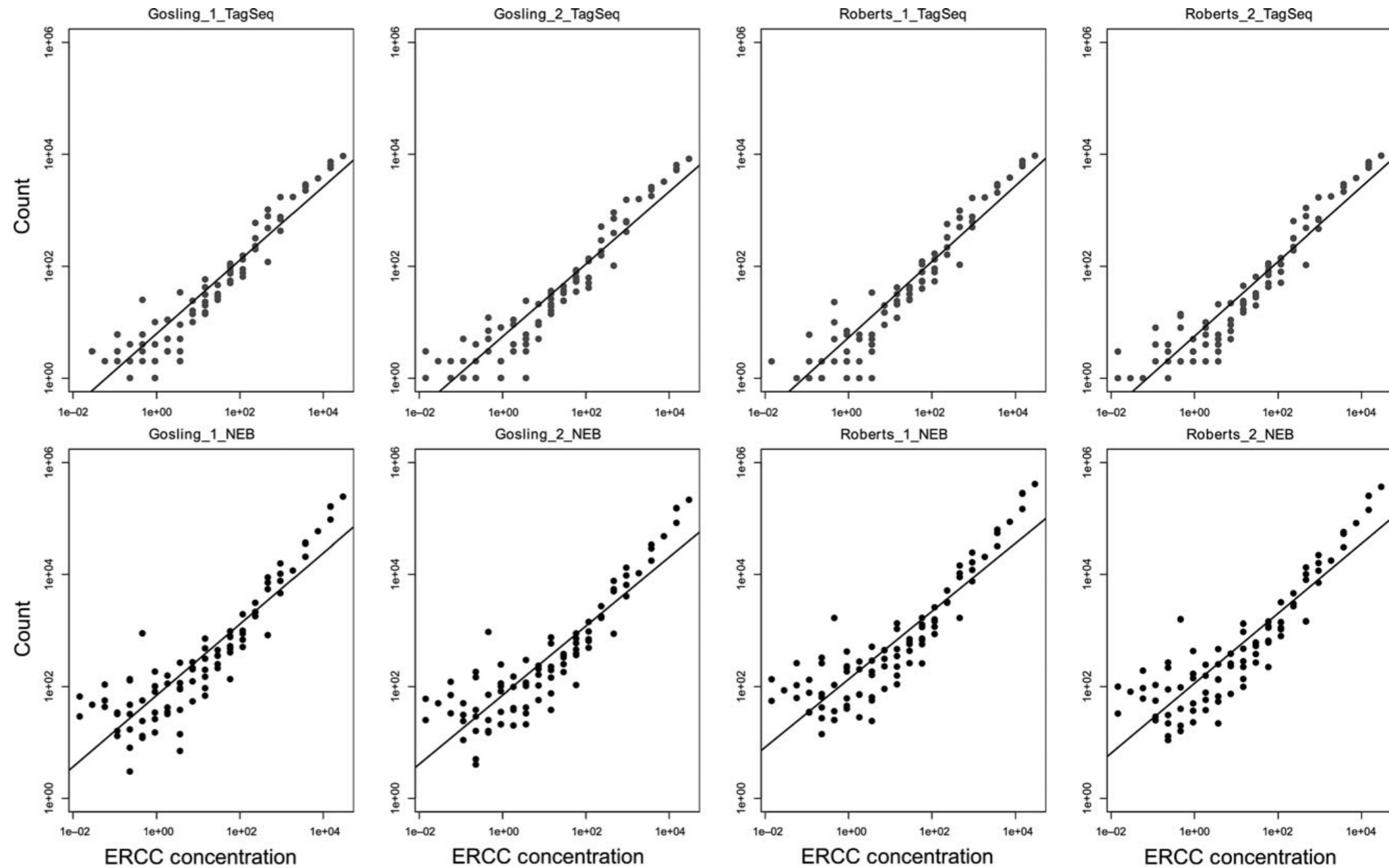

Fig. 1 Regression of observed vs. expected ERCC transcripts shows TagSeq has higher adjusted R^2 values for four different biological samples prepared with both methods (paired t -test, $t = 18.63$, d.f. = 3, $P < 0.001$).

Is Tag-Seq comparable to whole RNA-Seq?

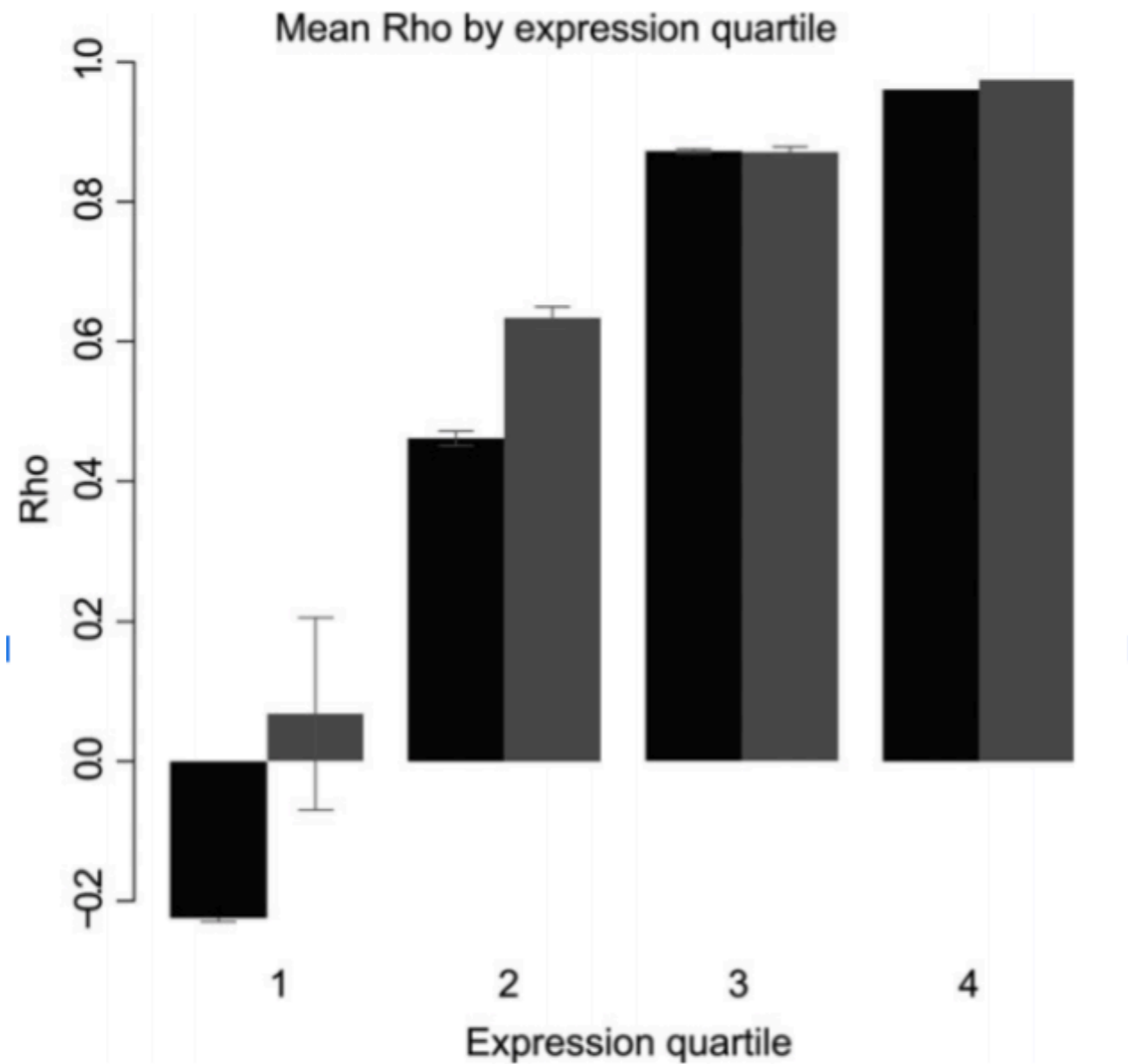

Fig. 3 Breakdown of control mRNAs by abundance class shows that TagSeq recovers mRNAs better than TruSeq, especially at lower abundances. Light grey bars are TagSeq, dark grey bars are whole mRNAseq. Fences indicate standard error.

How do we analyze RNA-Seq data?

- **STEP 1: PREPROCESS RAW DATA**
- **STEP 2: EVALUATE QUALITY**
- **STEP 3: MAP TO REFERENCE, ASSESS RESULTS**
- **STEP 4: QUANTIFY TRANSCRIPTS**
- **STEP 5: TEST FOR DIFFERENTIAL EXPRESSION**
- **STEP 6: VISUALIZE AND PERFORM OTHER DOWNSTREAM ANALYSIS**

STEP 1 - Preprocess Raw Data

https://github.com/z0on/tag-based_RNAseq

Tag-Seq Read Structure

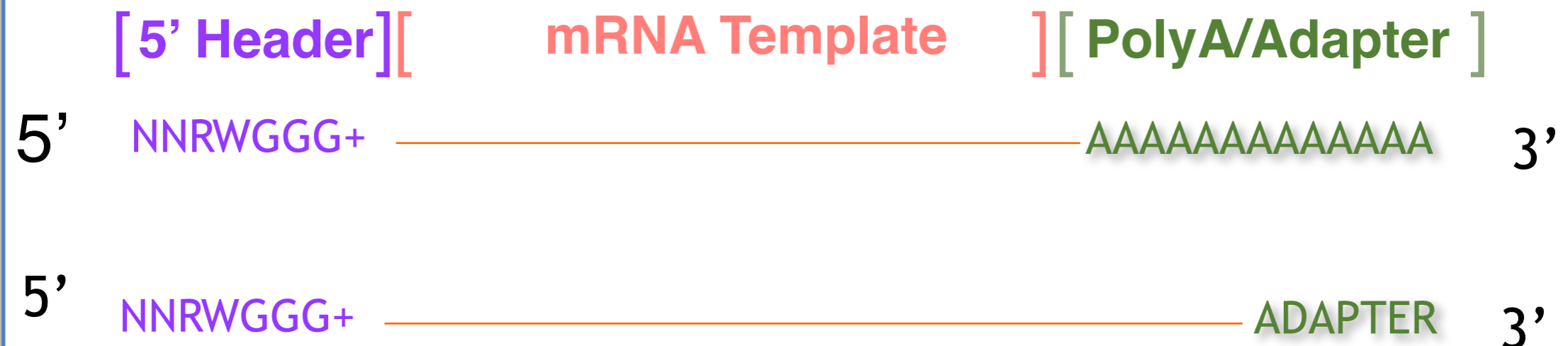

STEP 1- Preprocess Tag-Seq Data

Trim Header

Degenerate Base: More than one base possibility

N = A, T, G, or C

M = A or C

W = A or T

Before

[NNMWGGGN]AAAAAATTTGGGCCT

After

AAAAAATTTGGGCCT

STEP 1- Preprocess Tag-Seq Data

Remove Duplicates

Reads that share the same degenerate header and the first 20 bases of the sequence.

[NNMWGGGN]AAAAAAAAATTGGGCCT

Barcode

N N M W = 64 Possible Barcodes
4 * 4 * 2 * 2

STEP 1- Preprocess Tag-Seq Data

Filter polyA and low quality reads

Reads that share the same degenerate header and the first 20 bases of the sequence.

Homopolymer Count

Homopolymer Count

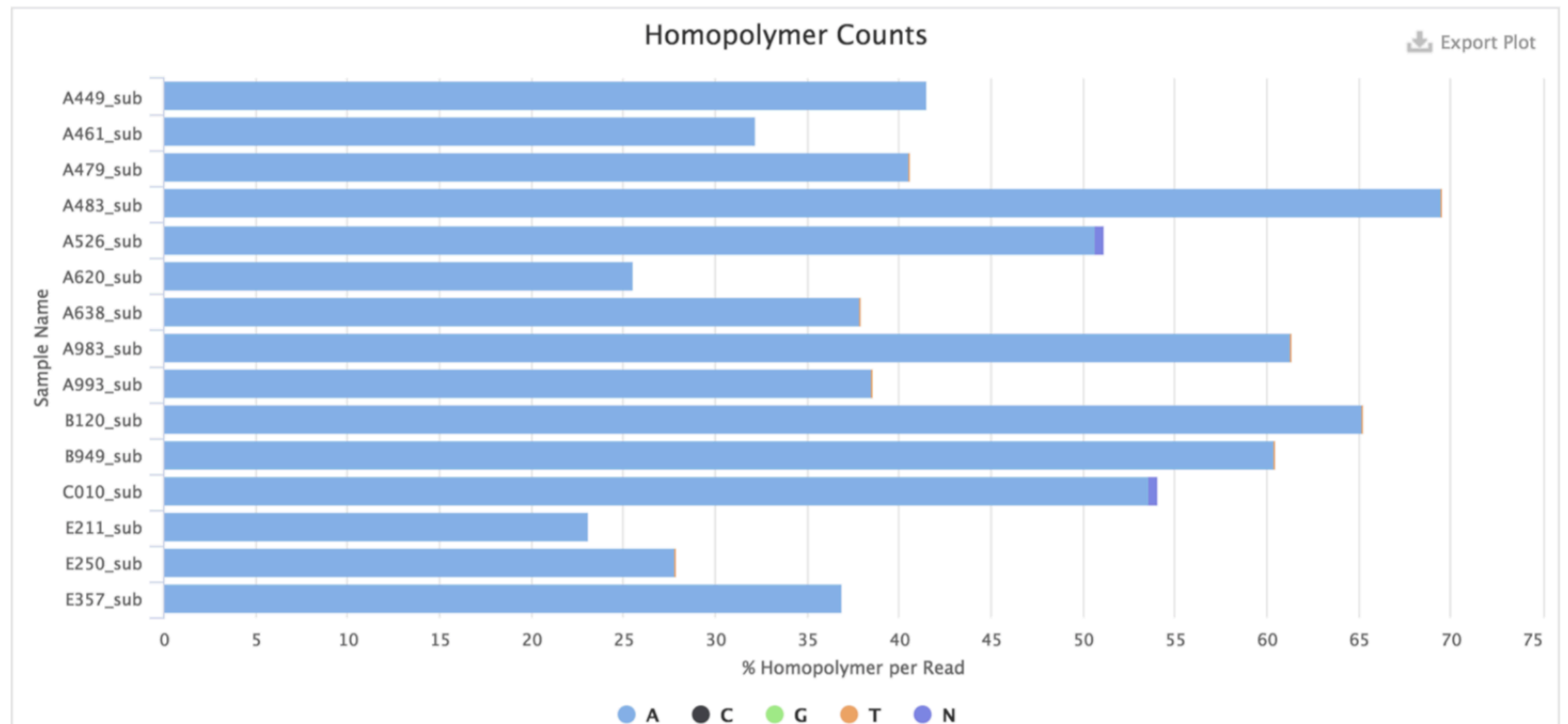

STEP 1- Preprocess Tag-Seq Data

Filter polyA and low quality reads

Reads that share the same degenerate header and the first 20 bases of the sequence.

PolyAs:

```
fastx_clipper -a AAAAAAAAA -l 20 -Q33
```

Low Quality Reads:

```
fastq_quality_filter -Q33 -q 20 -p 90
```

How do we analyze RNA-Seq data?

- **STEP 1: PREPROCESS RAW DATA**
- **STEP 2: EVALUATE QUALITY**
- **STEP 3: MAP TO REFERENCE, ASSESS RESULTS**
- **STEP 4: QUANTIFY TRANSCRIPTS**
- **STEP 5: TEST FOR DIFFERENTIAL EXPRESSION**
- **STEP 6: VISUALIZE AND PERFORM OTHER DOWNSTREAM ANALYSIS**

Pseudoaligners don't seem to perform as well with Tag-Seq Data

Sample	Kallisto Mapping %	BWA Mapping %
A1-WLD1_S28	61.2%	77.75%
A2-WLD2_S36	60.4%	77.68%
A3-WLD3_S44	59.5%	77.10%
A4-WLD4_S52	68.4%	79.17%

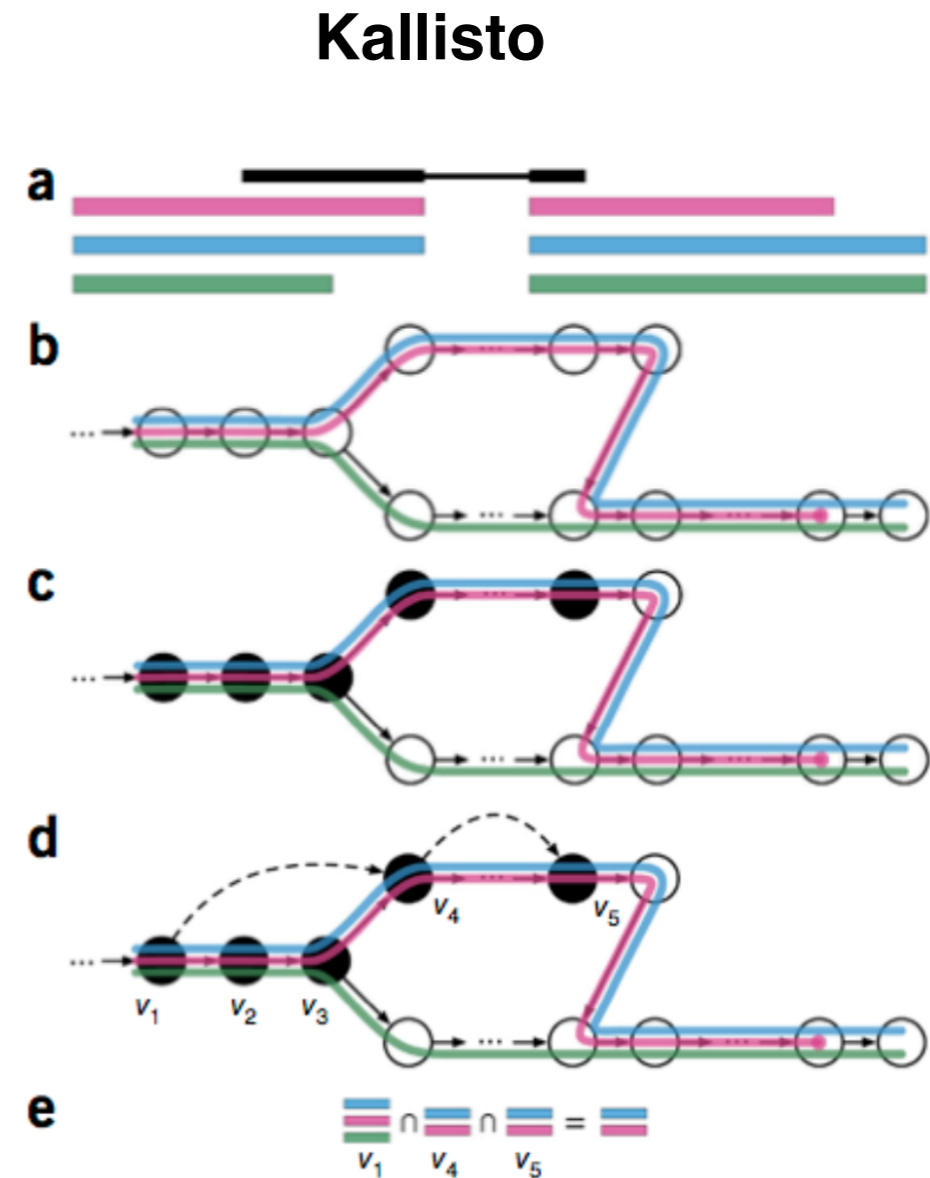

Mapping Summary

- For Tag-Seq, unspliced and spliced mappers would both work fine.
- Most often, you will map to the transcriptome instead of genome.
- For Tag-Seq, Avoid pseudoaligners like Kallisto.

Where is Tag-Seq Being Used?

Identifying Gene Expression Signatures for Drug Compounds

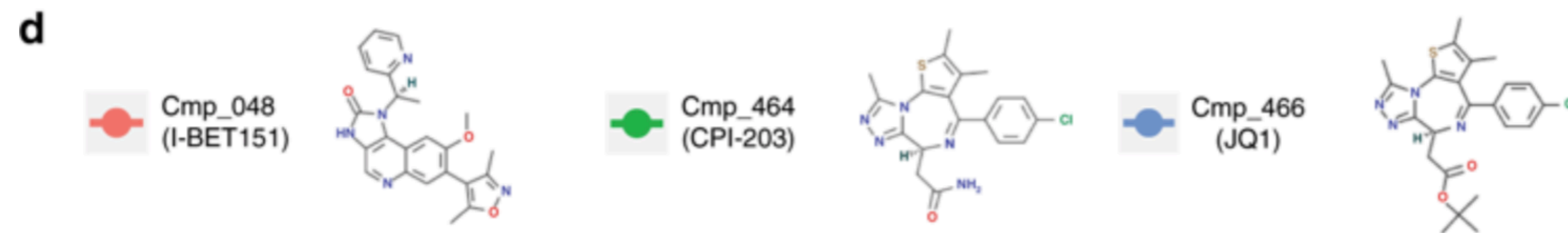
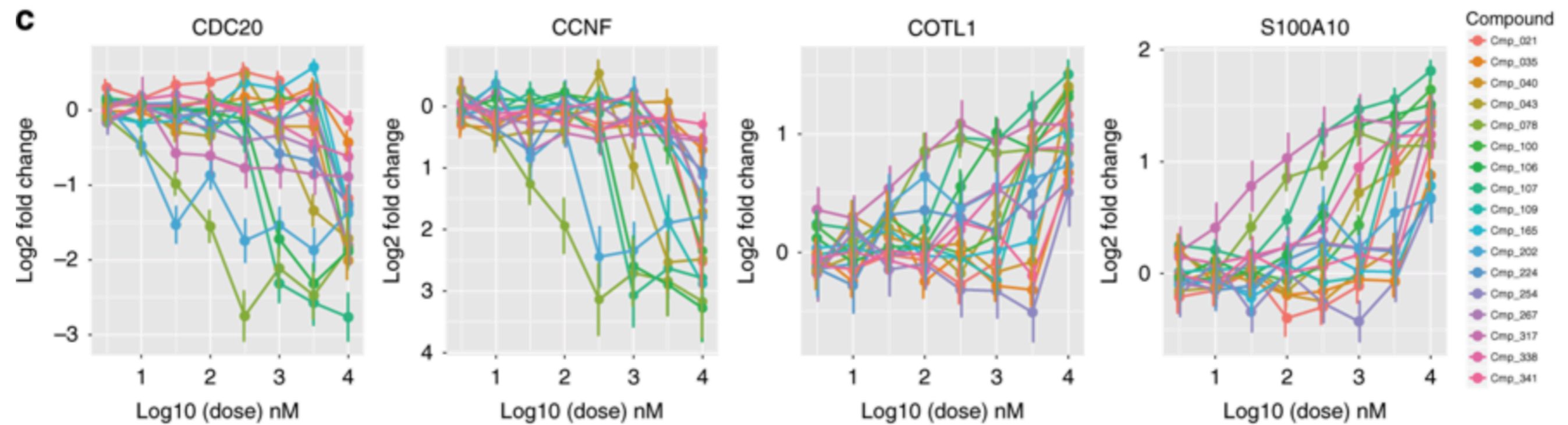

Where is Tag-Seq Being Used?

Studying Gene Expression Responses of Coral Larvae to Temperature Changes

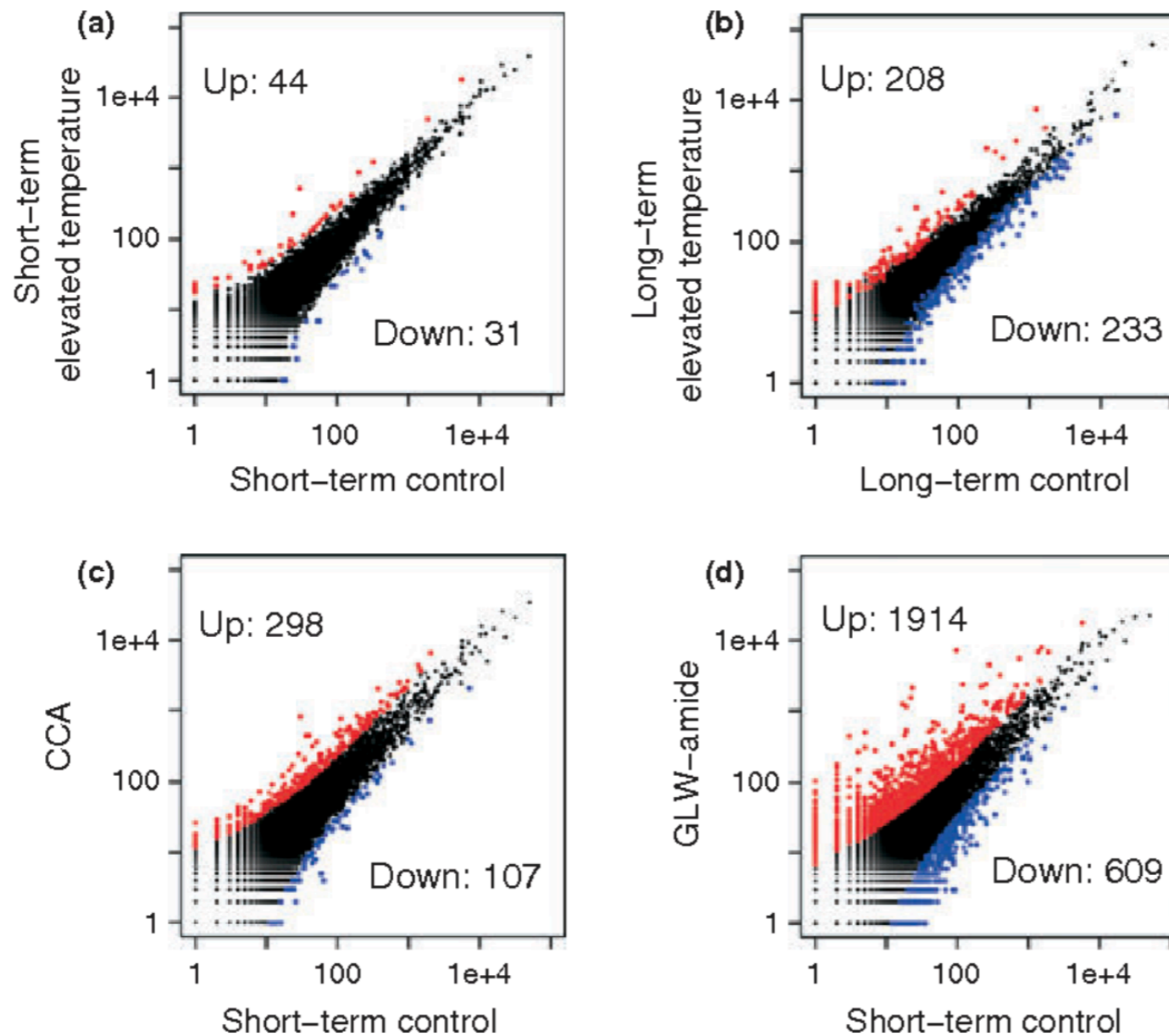

Where is Tag-Seq Being Used?

- Whole RNA-Seq for assembling a transcriptome.
- Tag-Seq for large number of samples for gene expression profiling.