

SOUND DEVICES



633

Portable Production Mixer and Recorder User Guide and Technical Information Firmware Version 1.02

Sound Devices, LLC
E7556 State Highway 23 and 33 • Reedsburg, WI • USA • 53959
+1 (608) 524-0625 • fax: +1 (608) 524-0655
Toll-Free: (800) 505-0625
www.sounddevices.com
support@sounddevices.com



Table of Contents

Panel Descriptions	1
Front Panel	1
Left (Input) Panel	3
Right (Output) Panel	3
Rear Panel	4
Quick Start Guide	5
Screen Overview	10
Primary Screen Elements	10
Meter Views	10
L, R, X1, X2, 1-6	10
L, R, 1-3	10
Input Settings Screen	11
L, R, 1-6	11
L, R, X1-X4, RTN	11
Routing Screens	13
LCD Daylight Mode	13
Inputs	14
Input Types	14
Input Routing	14
Pan Control	15
Trim and Fader Relationship	15
Input/Trim (Analog)	15
Input Trim (Digital)	15
Input Fader	16
Phantom Power	16
Digital Inputs	16
High-pass Filter	17
Polarity	17
Input Linking	18
M/S Matrixing	18
Limiters	19
Limiters	19
Linking Limiters	19
Metering	20
Meter Ballistics	20
VU	20
Peak + VU	20
Peak Only	20
Peak Hold	21
Input Activity LED	21
Headphone Clipping LED	21
Headphone Monitoring	22
Headphone Gain	22
Headphone Source Selection	22
Headphone Encoder Mode	23
Custom Headphone Presets	23
Favorite Headphone Source	24
PFL (Input Solo)	24
Headphone Bells	25
PFL Toggle Mode	25
RTN Monitoring	25
Output Setup and Control	26

Master Outputs (XLR-3M)	26	AES3 Digital Outputs (XLR-3M)	27
AUX 1/2 Outputs (TA3)	26	Adjusting Output Levels	27
AUX 3/4 Outputs (TRS)	26		

Slate Mic and Tone Oscillator 29

Slate Microphone	29	Routing Slate and Tone Signals	29
Tone Oscillator	29		

Recorder Setup and Control 31

Transport Control (Recording and Playback)	31	Bit Depth	35
Recording Tracks	31	Recording Media	35
Track Arming	31	Formatting Media	35
Track-to-Media Routing	32	Pre-Roll	36
Track Naming	32	“F Mode” Sample Rates	36
Digital Audio Format & File Format	34	48.048k and 48.048kF	36
WAV (Broadcast WAV) File Format	34	Fostex DV40	36
MP3 File Format	34	47.952k and 47.952kF	36
MP3 Bit Rate	34	Playback	37
Sample Rate	35		

File Management 38

File List	38	Take Management	44
File Format	39	Take List	44
File Structure	39	Take Number	45
Folder Options	40	False Take	45
Automatic File Splitting	41	Scene Name	45
Metadata Fields	41	Scene Increment	46
Metadata in MP3 Files	42	Take Notes and Phrases	46
Sound Reports	42	Phrases	46
Sound Report Setup	43		
Overview Section	43		
Take List Section	43		
Generating Sound Reports	44		

Timecode 47

Timecode Modes	47	Timecode Frame Rate	49
Record Run	48	Jam Menu	49
Free Run	48	Timecode Hold Off	50
Free Run Auto Mute	48	Time Zone and Daylight Savings	51
24h Run (24 hour Run)	48	Time and Date Format	51
24h Run Auto Mute	48		
External Timecode	48		
External Timecode Auto-Record	48		
External Timecode Continuous	48		
External Timecode Auto-Record Continuous	48		

Powering 52

External DC Powering	52	QuickBoot	54
L-Mount Battery Powering	52	Power Consumption	55
AA Battery Powering	52		
Voltage Metering	52		
Power Screen	53		
Voltage Range	53		
PowerSafe	54		

Using a USB Keyboard	56
Storing and Recalling Settings	57
Setup Menu	58
Power	58
Inputs	58
Outputs	58
Limiters	59
Recorder	59
Timecode	60
File Storage	61
System	62
Quick Setup	63
Front Panel Button Shortcuts	65
Connector Pin Assignments	66
Specifications	67
Analog Inputs	67
Digital Inputs	67
Analog Outputs	68
Digital Outputs/Recorder	68
Timecode and Sync	69
Power	69
Environmental	69
Dimensions and Weight	69
Accessories	70
Wave Agent	71
Index	72
Declaration of Conformity	74
Warranty and Technical Support	75

Copyright and Release

All rights reserved. No part of this publication may be reproduced, stored in a retrieval system, or transmitted in any form or by any means, electronic, mechanical, photocopying, recording, or otherwise, without the expressed written permission of SOUND DEVICES, LLC. SOUND DEVICES is not responsible for any use of this information.

SOUND DEVICES, LLC shall not be liable to the purchaser of this product or third parties for damages, losses, costs, or expenses incurred by purchaser or third parties as a result of: accident, misuse, or abuse of this product or unauthorized modifications, repairs, or alterations to this product, or failure to strictly comply with SOUND DEVICES, LLC's operating and installation instructions.

Microsoft Windows is a registered trademark of Microsoft Corporation. Macintosh is a registered trademark of Apple, Inc. Other product and company names mentioned herein may be the trademarks of their respective owners.

The sound waves logo is a registered trademark of Sound Devices, LLC.

Limitation of Liability

LIMITATION ON SOUND DEVICES' LIABILITY. SOUND DEVICES, LLC SHALL NOT BE LIABLE TO THE PURCHASER OF THIS PRODUCT OR THIRD PARTIES FOR DAMAGES, LOSSES, COSTS, OR EXPENSES INCURRED BY PURCHASER OR THIRD PARTIES AS A RESULT OF: ACCIDENT, MISUSE, OR ABUSE OF THIS PRODUCT OR UNAUTHORIZED MODIFICATIONS, REPAIRS, OR ALTERATIONS TO THIS PRODUCT, OR FAILURE TO STRICTLY COMPLY WITH SOUND DEVICES, LLC'S OPERATING AND INSTALLATION INSTRUCTIONS. TO THE FULLEST EXTENT PERMITTED BY LAW, SOUND DEVICES SHALL HAVE NO LIABILITY TO THE END USER OR ANY OTHER PERSON FOR COSTS, EXPENSES, DIRECT DAMAGES, INCIDENTAL DAMAGES, PUNITIVE DAMAGES, SPECIAL DAMAGES, CONSEQUENTIAL DAMAGES OR OTHER DAMAGES OF ANY KIND OR NATURE WHATSOEVER ARISING OUT OF OR RELATING TO THE PRODUCTS, THESE TERM/S AND CONDITIONS OR THE PARTIES' RELATIONSHIP, INCLUDING, WITHOUT LIMITATION, DAMAGES RESULTING FROM OR RELATED TO THE DELETION OR OTHER LOSS OF AUDIO OR VIDEO RECORDINGS OR DATA, REDUCED OR DIMINISHED AUDIO OR VIDEO QUALITY OR OTHER SIMILAR AUDIO OR VIDEO DEFECTS ARISING FROM, RELATED TO OR OTHERWISE ATTRIBUTABLE TO THE PRODUCTS OR THE END USER'S USE OR OPERATION THEREOF, REGARDLESS OF WHETHER SUCH DAMAGES ARE CLAIMED UNDER CONTRACT, TORT OR ANY OTHER THEORY. "CONSEQUENTIAL DAMAGES" FOR WHICH SOUND DEVICES SHALL NOT BE LIABLE SHALL INCLUDE, WITHOUT LIMITATION, LOST PROFITS, PENALTIES, DELAY DAMAGES, LIQUIDATED DAMAGES AND OTHER DAMAGES AND LIABILITIES WHICH END USER SHALL BE OBLIGATED TO PAY OR WHICH END USER OR ANY OTHER PARTY MAY INCUR RELATED TO OR ARISING OUT OF ITS CONTRACTS WITH ITS CUSTOMERS OR OTHER THIRD PARTIES. NOTWITHSTANDING AND WITHOUT LIMITING THE FOREGOING, IN NO EVENT SHALL SOUND DEVICES BE LIABLE FOR ANY AMOUNT OF DAMAGES IN EXCESS OF AMOUNTS PAID BY THE END USER FOR THE PRODUCTS AS TO WHICH ANY LIABILITY HAS BEEN DETERMINED TO EXIST. SOUND DEVICES AND END USER EXPRESSLY AGREE THAT THE PRICE FOR THE PRODUCTS WAS DETERMINED IN CONSIDERATION OF THE LIMITATION ON LIABILITY AND DAMAGES SET FORTH HEREIN AND SUCH LIMITATION HAS BEEN SPECIFICALLY BARGAINED FOR AND CONSTITUTES AN AGREED ALLOCATION OF RISK WHICH SHALL SURVIVE THE DETERMINATION OF ANY COURT OF COMPETENT JURISDICTION THAT ANY REMEDY HEREIN FAILS OF ITS ESSENTIAL PURPOSE.

Panel Descriptions

Front Panel

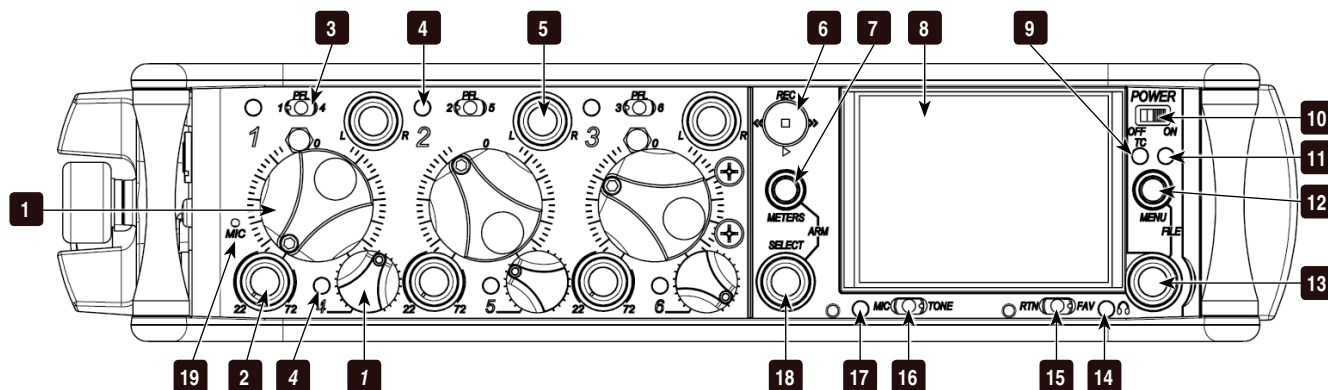

- 1) **Input Fader**
Primary control for adjusting the level of Inputs during operation. Ranges from off to +16 dB. Nominal setting is in the middle (0 dB). The three large knobs control Inputs 1, 2, and 3. The three smaller knobs along the bottom control Inputs 4, 5, and 6 (Push to recess; Push again to extend).
- 2) **Gain / Trim (Ch. 1 to Ch. 3)**
Coarse input gain control for Inputs 1, 2, and 3. Sets the initial input sensitivity level so that the Input Fader can be used for fine gain adjustments. Range is from +22 dB to +72 dB. Trim level for Inputs 4, 5, and 6 are controlled from the respective input Settings Screen. (See *"Inputs"*, page 14)
- 3) **PFL / Input Select Switch**
Slide the switch toward the indicated number to display that input's Input Settings Screen and PFL ("solo") the input. Does not affect Master Output signal. Slide the switch the same direction again to deactivate the PFL and return to the previous screen. To momentarily PFL an input, slide the switch toward the input's number and hold for 1 second or more. This functionality is altered when **INPUTS > PFL Toggle Mode** is set to **3ch**. (See *"Inputs"*, page 14)
- 4) **Input Activity LED**
Indicates input signal activity. Illuminates in various colors and intensities to show signal level and activity. Green = signal presence (pre-fader), yellow = limiter activity (pre- and post-fader), red = signal overload/clipping (pre- and post-fader), flashing yellow = input PFL. Input LED's for Inputs 1, 2, and 3 are located above the Input's Fader knob. Input LED's for Inputs 4, 5, and 6 are located directly left of the Input's fader knob.
- 5) **Input Pan (Ch. 1 to Ch. 3)**
Controls the Left/Right balance of the input signal to the Stereo Master Bus (Push to recess; Push again to extend). Inputs 4, 5, and 6 are routed to the Left and Right mix via the respective Input Settings Screen. (See *"Inputs"*, page 14)
- 6) **Transport Control**
Controls the Integrated Digital Recorder. Slide up to Record, press in to Pause/Stop, slide down to Play, slide left to Rewind, slide right to Fast Forward. (See *"Recorder Setup and Control"*, page 31)
- 7) **Meters Button**
Displays the Main Screen which includes metering, filename, timecode and other important information. Cycles between set meter presentations when pressed from Main Screen ((See *"Meter Views"*, page 10)). Returns to Main Screen from any other Screen.

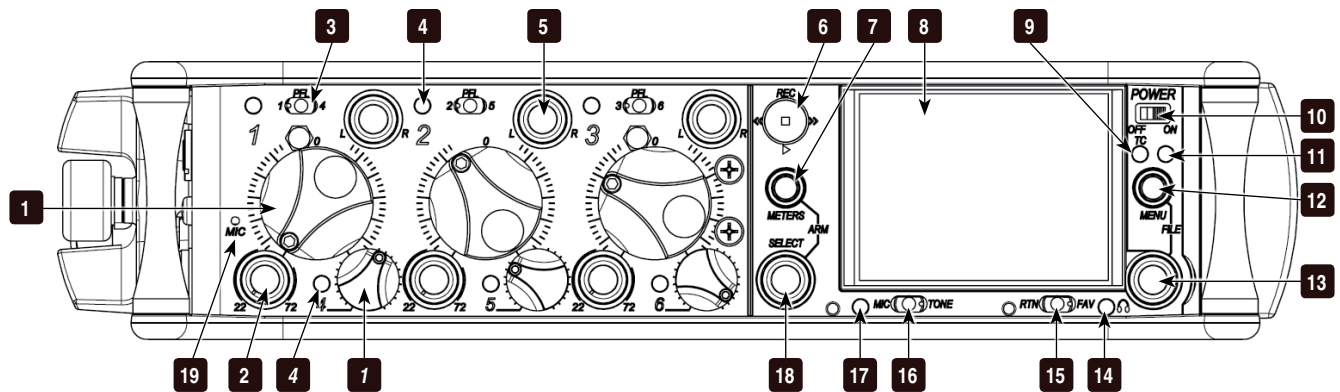

- 8) **LCD**
Displays contextual operating information and user interface.
- 9) **Internal Timecode LED**
When the 633 is powered down and timecode Mode is Freerun or 24-Hour Run, the Internal Timecode LED will flash blue to indicate that timecode is being maintained. The 633 will hold accurate timecode for 2 hours after being powered down.
- 10) **Power Switch**
Two-position slide switch, slides left to power the 633 off and slides right to power the 633 on.
- 11) **Power LED**
Illuminates green to indicate the 633 is powered on.
- 12) **Menu Button**
Displays the Setup Menu.
- 13) **Headphone Encoder**
Main and Input Settings Screen: Turn to adjust headphone gain. In Main Screen: Press to select Headphone Source. In Menus: Turn to navigate; Press to make selection. In Input Settings Screen: press to select input source. Headphone gain and preset selection functions can be reversed: (See “Headphone Monitoring”, page 22)
- 14) **Headphone Clipping LED**
Illuminates red to indicate headphone output is approaching clipping level.
- 15) **RTN / FAV Switch**
Slide Left to monitor RTN signal in headphones. Slide right to activate the headphone preset that has been marked as “favorite”. (See “Favorite Headphone Source”, page 24)
- 16) **Mic / Tone Switch**
Slide left to activate the Slate Microphone, slide again to deactivate. For momentary action hold for one second or longer. Slide right to activate the Tone Oscillator. Tone will latch if held for one second or longer; slide again to deactivate.
- 17) **Slate Mic / Tone LED**
Illuminates green when Slate Mic or tone is active.
- 18) **Select Encoder**
Multi-function encoder. Selects Tracks, RTN’s, and AUX buses on the Main Screen. On the Main Screen, press and hold the Select Encoder and then press the Meters Button to arm/disarm the currently highlighted track. With L, R, X1, X2, X3, X4, or RTN selected, press then turn to adjust level. Vertical Scroll in matrix windows. Turn to adjust trim level in Input Settings Screens 4-6 and inputs with AES selected. Turn to scroll cursor and press to insert a space character during text entry. Acts as shift button to access secondary functions. (See “Front Panel Button Shortcuts”, page 65)
- 19) **Slate Microphone**
The slate mic transducer. (See “Slate Mic and Tone Oscillator”, page 29)

Left (Input) Panel

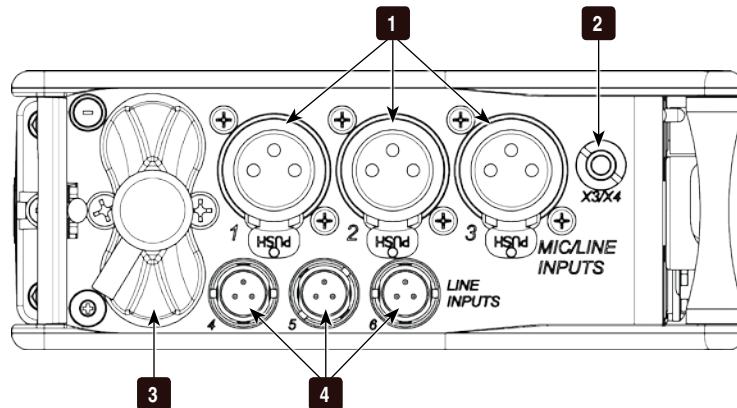

- 1) **XLR-3F Inputs 1-3**
Active-balanced analog microphone- or line-level input for inputs 1-3 on XLR-3F connector. Input type is set within the Input Settings Screen. Can supply 12V or 48V phantom power. Input 1 can also accept AES3 or AES42 (Mode 1) signal. Pin-1 ground, pin-2 (+), pin-3 (-).
- 2) **AUX 3/4 Output**
Multi-purpose auxiliary analog output. Two channels on unbalanced 3.5 mm TRS connection. Level can be adjusted from -30 dB (mic level) up to 0 dB (sufficient for driving headphones). (See "AUX 3/4 Outputs (TRS)", page 26)
- 3) **Battery Compartment**
Holds 6 AA batteries; Three batteries in two rows held by screw cap. Top row batteries inserted with negative (-) end facing out; Bottom row batteries inserted with positive (+) end facing out.
- 4) **TA3 Analog Line Inputs 4-6**
Analog line inputs 4-6. Pin-1 ground, pin-2 (+), pin-3 (-). Float pin 3 to unbalance.

Right (Output) Panel

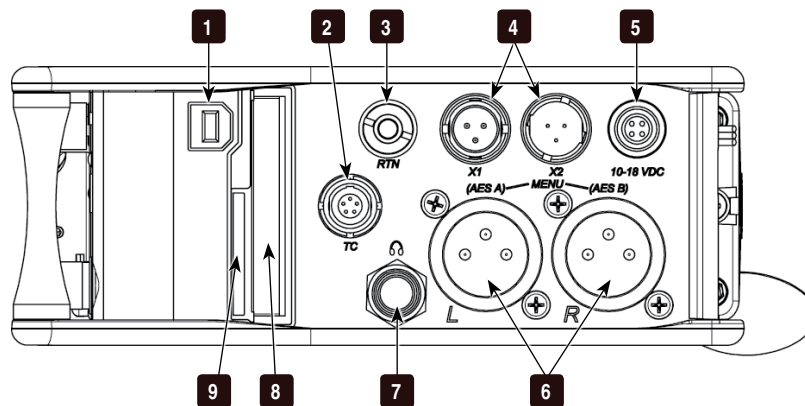

- 1) **USB B Connector**
USB connection for keyboard or factory use.
- 2) **Timecode I/O**
Timecode input and output on 5-pin LEMO® connector.

- 3) **RTN Input**
Unbalanced stereo 3.5 mm female connector for Return audio input. Sleeve = Ground, Tip = Left, Ring = Right.
- 4) **X1 and X2 Outputs**
Line, -10, or Mic level selected in the Setup Menu section **OUTPUTS**. Pin-1 ground, pin-2 (+), pin-3 (-). Float pin 3 to unbalance.
- 5) **DC Input**
Accepts DC voltages from 10–18 V for powering. Pin 1 = Negative (-), pin 4 = Positive (+).
- 6) **XLR-3M Master Outputs**
Balanced analog outputs on standard 3-pin XLR-3M connectors. Mic, Line, -10, or AES (1,2 and 3,4 on L and R respectively) selectable from Setup Menu section **OUTPUTS**. Pin-1 ground, pin-2 (+), pin-3 (-). Unbalance by grounding pin 3 to pin 1.
- 7) **Headphone Output**
1/4-inch TRS stereo headphone connector. Can drive headphones from 8 to 1000 ohm impedances to very high levels. Tip = left, ring = right, sleeve = ground.
- 8) **CompactFlash Slot**
Accepts approved CompactFlash cards with the label-side toward the rear of the 633. Compatible with Type I and Type II cards. High-speed UDMA cards are recommended for higher track count recording. See <http://www.sounddevices.com/approved> for a list of approved media.
- 9) **SD Card Slot**
Accepts approved SD/SDHC/SDXC cards with the notched corner oriented toward the top of the 633. Insert until it clicks securely in the slot. The card should glide smoothly into the slot. Press to eject. See <http://www.sounddevices.com/approved> for a list of approved media.

Rear Panel

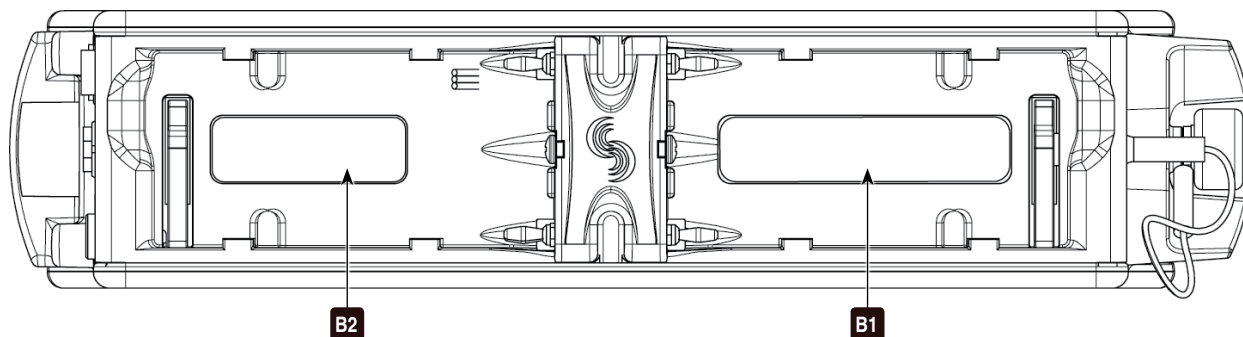

Two battery mounts (“slots”) on the rear panel for Sony® L-Series type lithium batteries. Any capacity supported. Battery slots labeled B1 and B2 in the diagram above correspond to the labels in the Setup Menu section **POWER**. (See “Powering”, page 52)

Quick Start Guide

This section provides a brief overview of basic 633 operation. The steps will demonstrate powering the 633, connecting an analog audio source to an input, connecting headphones, setting up monitoring, preparing media for recording, and making a recording. Refer to the rest of this user guide for full details on all 633 features.

1) Connect Power

Connect at least one power source. For external powering, connect a DC powering source (not included) to the DC connector on the Right Panel. For internal powering from AA batteries, unscrew the battery cap (counter-clockwise), insert six AA NiMH batteries (not included) the battery tubes. Orient the top three batteries with the positive (+) side facing in and the bottom three batteries with the negative (-) side facing in.

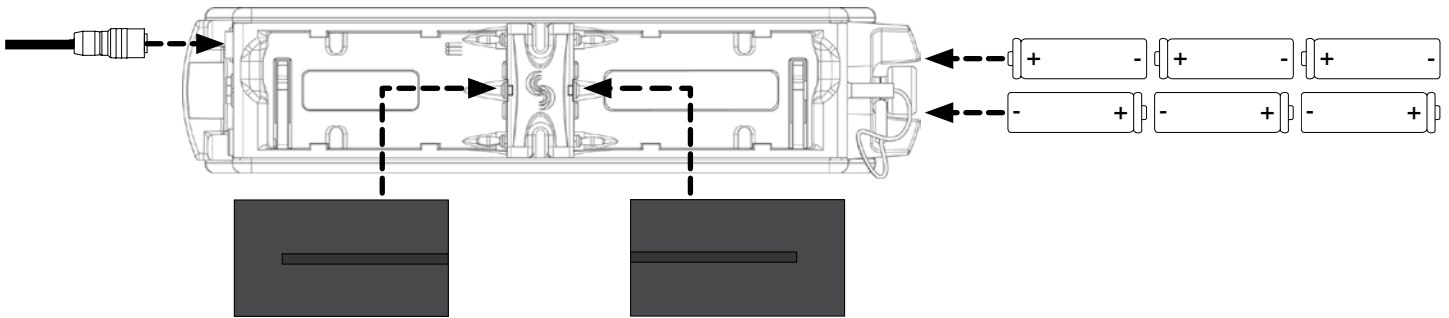

2) Power On the 633

Slide the Power Switch right. The LCD will briefly display a boot screen with the Sound Devices logo and then the Main Screen will be displayed:

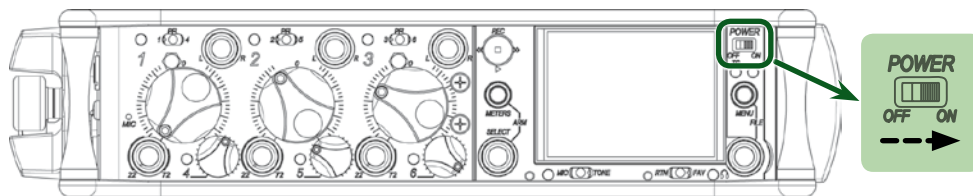

3) Connect Audio Source

Using a standard XLR cable, connect a microphone or line level analog source to Input 1 on the left panel.

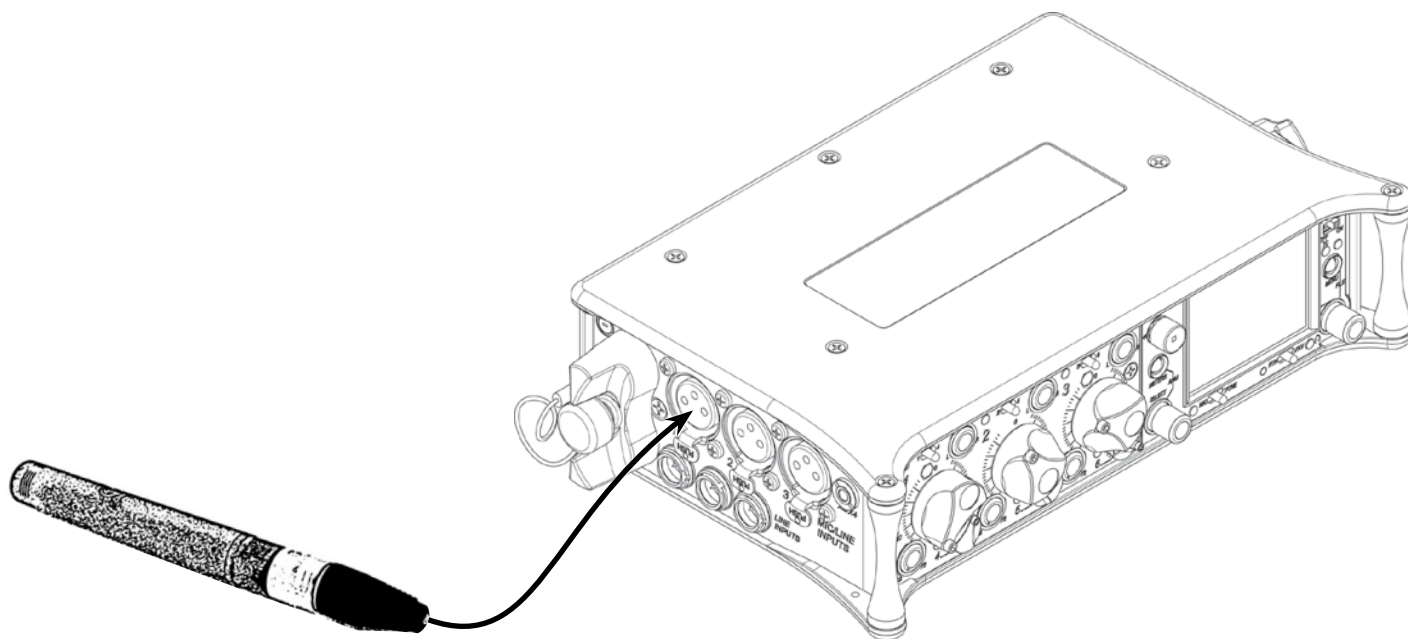

4) Power On Input

If the Input 1 trim knob is recessed, pop it up by pushing it in. If the trim knob is rotated fully counter-clockwise, the input is powered off. To power the input on, rotate the trim knob clockwise until it clicks.

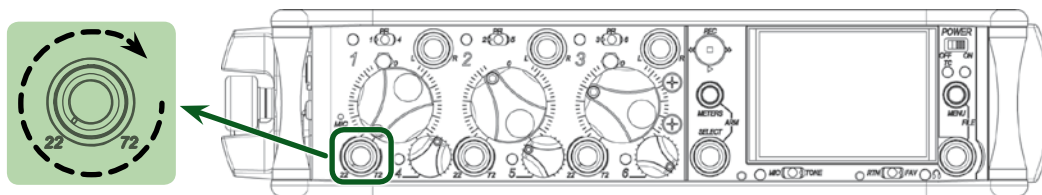

5) Select Input Type

Slide Input 1's the Input Select Switch left to display the Input Settings Screen for Input 1. Press the Headphone Encoder to display a list of available input types. Rotate the Headphone Encoder to select an input type and press the Headphone Encoder to select that type. Choose **MIC** for a dynamic microphone, **MIC-PH** for microphones requiring phantom power, or **LINE** for analog line level sources. Slide Input 1's the Input Select Switch left again to return to the Main Screen.

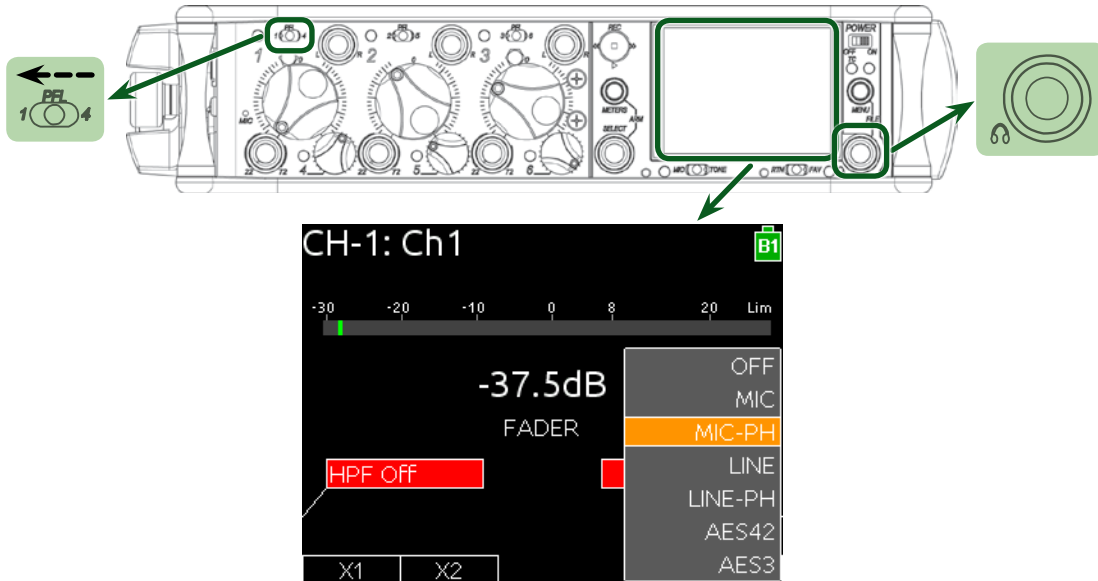

6) Connect Headphones

Connect headphones to the 1/4-inch headphone output on the right panel.

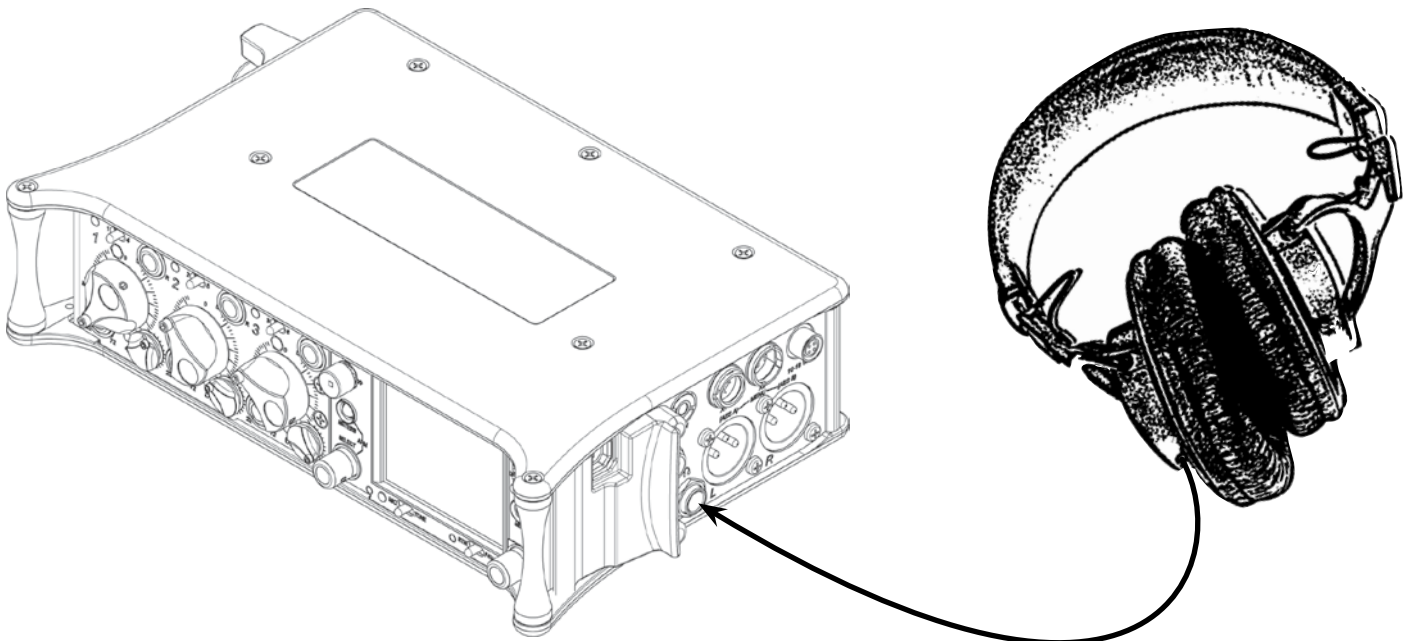

7) Select a Headphone Source

Press the Headphone Encoder to display a list of available headphone Headphone Sources. Rotate the Headphone Encoder to choose **LR ST** (The master left and right stereo bus), then press the HEadphone Encoder to confirm the selection.

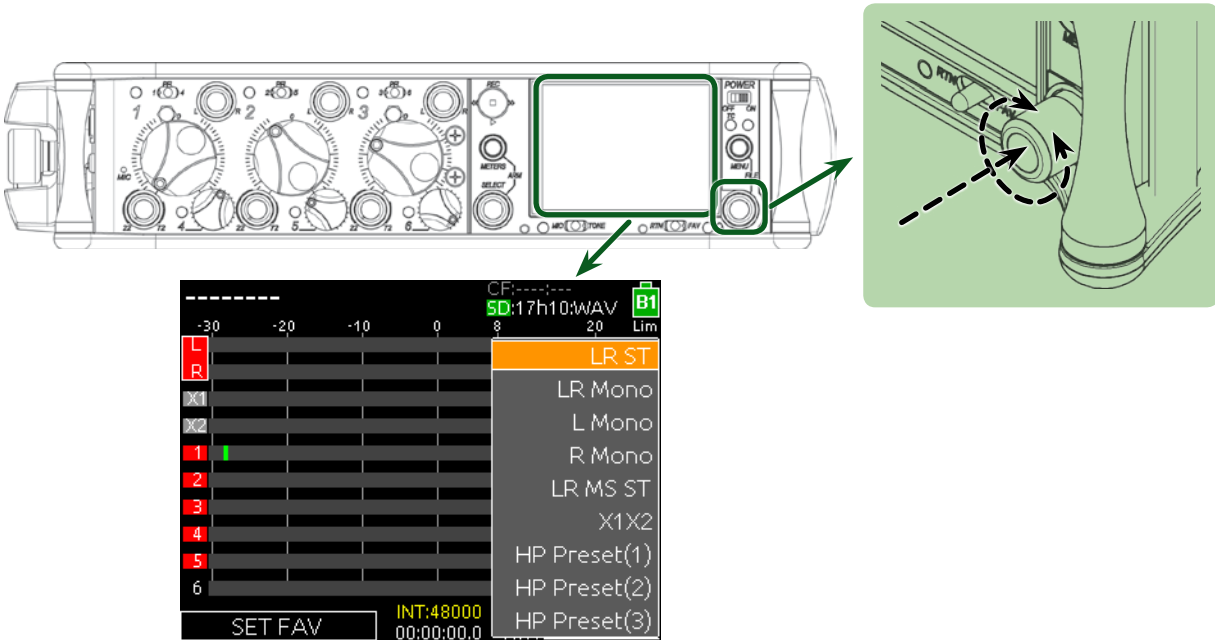

8) Insert SD or CF Media

Open the Media Door on the right panel. The door is secured magnetically. Pull firmly to open. Insert the SD card with the bottom of the card (the side with metal contacts visible) facing toward the rear of the 633. Insert the CF card with the top of the card (the side with the manufacturer's branding label) facing the rear of the 633.

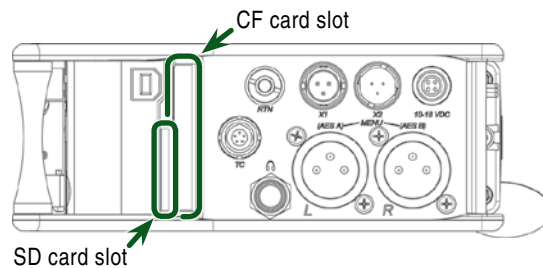

9) Format Media

The SD or CF card must be formatted before recording. This will erase all data on the card.

1. Press the Menu Button to access the Setup Menu.
2. Rotate the Headphone Encoder to highlight FILE STORAGE.
3. Press the Headphone Encoder to access the FILE STORAGE sub-menu.

4. Rotate the Headphone Encoder to highlight Erase/Format CF or Erase/Format SD.
5. Press the Headphone Encoder to begin the formatting process.
6. Press the Headphone Encoder to accept the warning messages. The formatting process will begin.
7. Press the Meters Button to return to the Main Screen.

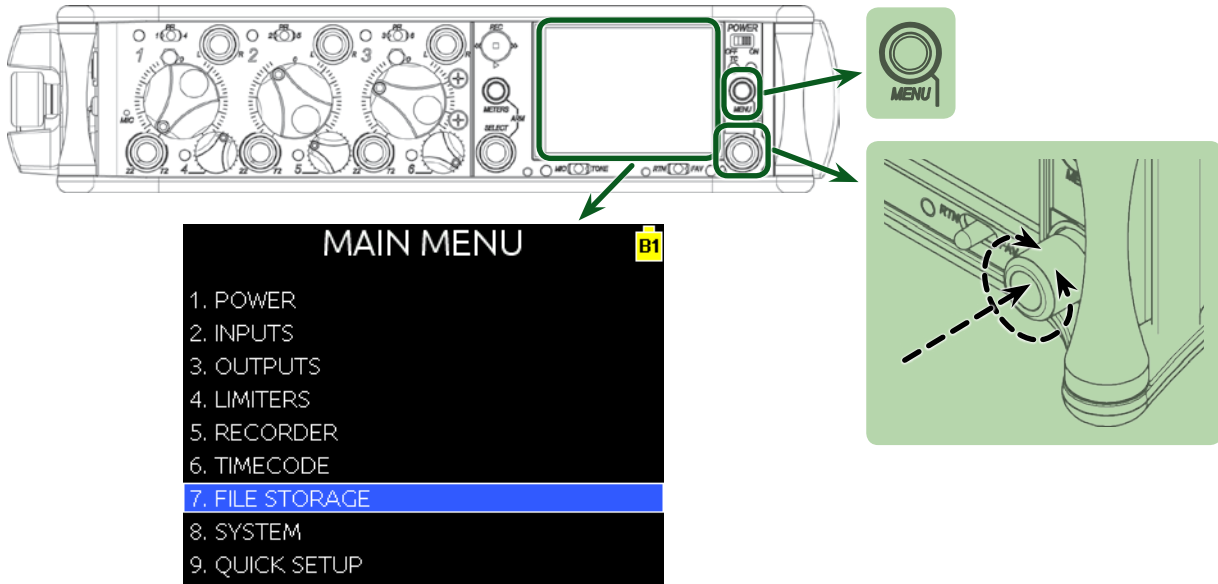

10) Use Transport Control to Record and Stop

Slide the Transport Control up to begin recording. The background color of the Take name on the top of the Main Screen will become red and the absolute time counter on the bottom of the Main Screen will run to indicate recording is taking place.

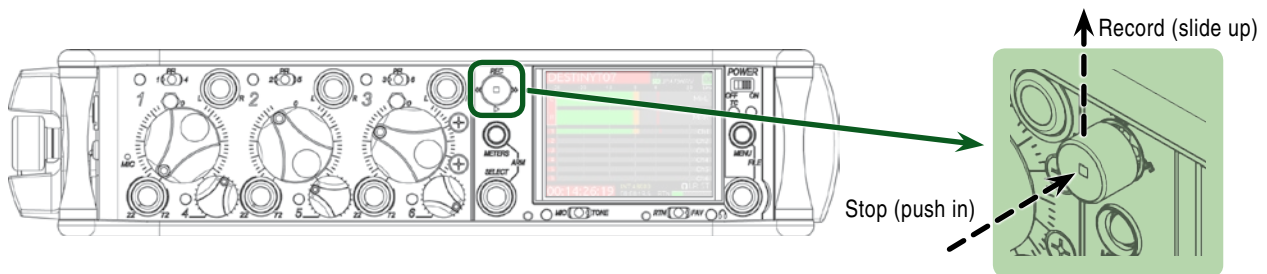

11) Remove Media to Transfer Files

When finished recording, open the Media Door and remove the SD or CF card. To remove the SD card, push it in to release. To remove the CF card, simply pull it out. Connect the SD or CF card to any computer to transfer files.

Screen Overview

Primary Screen Elements

The Main Screen displays important information at-a-glance. The Main Screen can be accessed quickly from any other screen by pressing the Meters Button. Press and hold the Meters Button, then slide the RTN / FAV Switch to the left to toggle between display of timecode frame rate and sample rate.

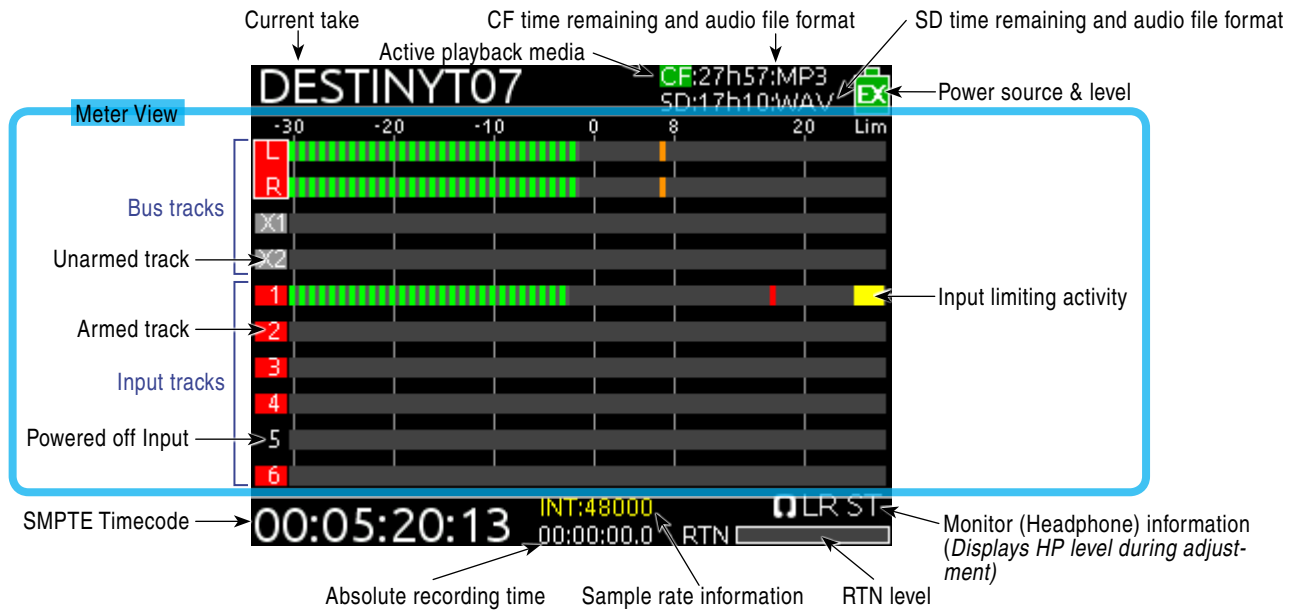

This screen shot shows default settings. Meter Style can be changed to solid (See “Metering”, page 20) and track names can optionally be shown in the meters (See “Track Naming”, page 32).

Meter Views

Pressing the Meters Button from the Main Screen will cycle through different Meter Views on the Main Screen. There are 3 views to cycle through and each view can be set to one of four configurations from Setup Menu option **SYSTEM > Meter Options**: The second and third meter view can be turned off so that only one meter view is shown on the Main Screen at all times.

L, R, X1, X2, 1-6

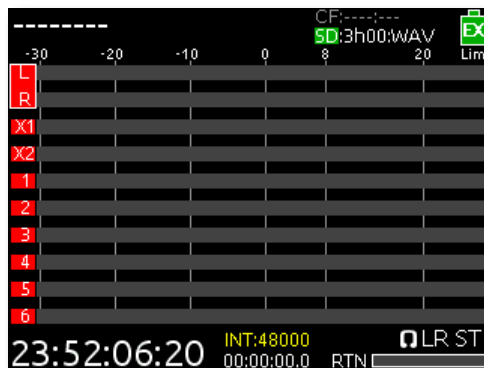

L, R, 1-3

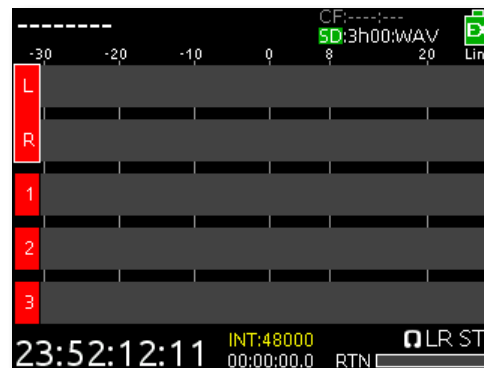

L, R, 1-6

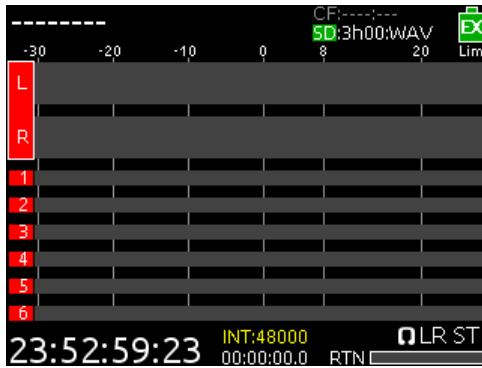

L, R, X1-X4, RTN

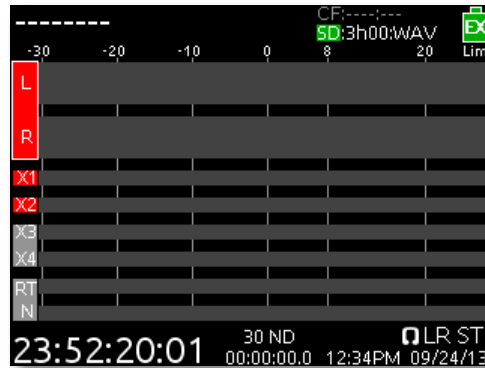

Note that the time and date is displayed in place of the small RTN meter on the L, R, X1-X4, RTN Meter View

Input Settings Screen

The Input Settings Screen displays all relevant information for the selected input as well as allowing these parameters to be changed. The default method for accessing the Input Settings Screen for inputs 1-6 is to slide the Input Select Switch toward the desired input number. This functionality can be altered when Setup Menu option **INPUTS > PFL Toggle Mode** is set to **3ch** (See “PFL Toggle Mode”, page 25).

When the Input Settings Screen is accessed, that input is soloed in the headphones (the Headphone Source is changed to PFL of the selected Input). The Headphone Source changes back to its previous source when the Input Settings Screen is exited. The Input Settings Screen can be entered without altering the Headphone Source by holding the Select Encoder down while sliding the input Select Switch. This behavior is reversed when Setup Menu option **INPUTS > PFL Toggle Mode** is set to **3ch** (See “PFL Toggle Mode”, page 25).

The following two screen shots are of Input 2 and Input 4, respectively. These examples demonstrate how Input Settings Screens 1-3 differ from Input Settings Screens 4-5.

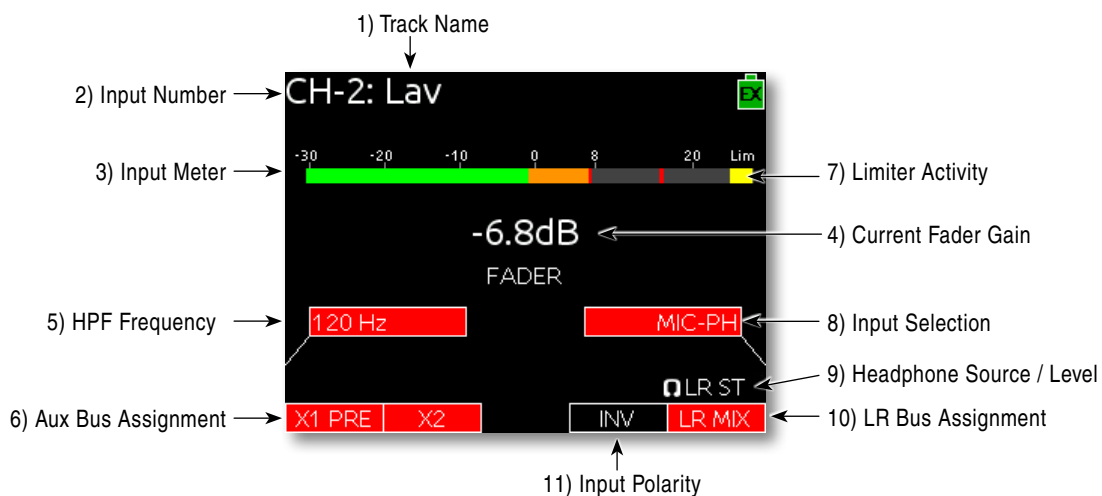

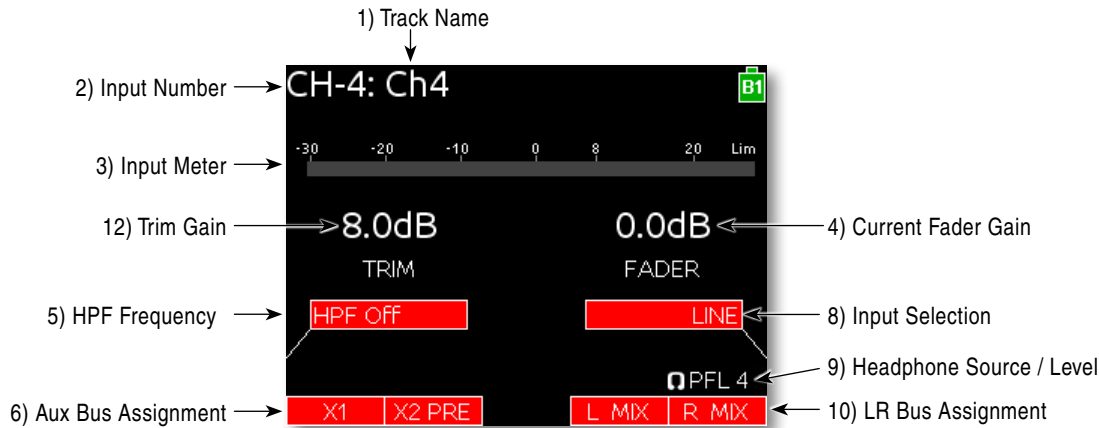

- 1) **Track Name**
The name of the input's ISO track. The Track Name can be edited directly from the Input Settings Screen. (See "Track Naming", page 32)
- 2) **Input Number**
The Input's number (1 through 6).
- 3) **Input Meter**
Displays the Input's signal level and limiting activity. The level displayed is the level to the Iso Track and will be pre- or post-fader depending on the Iso Track Status. Meter ballistics can be set globally from VU or Peak+VU in Setup Menu item **SYSTEM > Meter Ballistics**. (See "Metering", page 20)
- 4) **Current Fader Gain**
The dB value of the input's fader. (See "Trim and Fader Relationship", page 15)
- 5) **HPF Frequency**
Displays the frequency of the Input's high pass filter (Or **HPF OFF** when the high pass filter is off). To adjust the high pass filter, press the Select Encoder, then turn the Select Encoder. (See "High-pass Filter", page 17)
- 6) **Aux Bus Assignment**
Displays the status of the Input's assignment to the X1 and X2 Output Buses. Inputs can be routed to X1 and X2 pre- or post-fader. Slide the Mic / Tone Switch left for the X1 bus and right for the X2 bus to cycle through the available options. Routed signal is indicated by a red background and unrouted signal by a black background. (See "Input Routing", page 14)
- 7) **Limiting Activity**
Indicates that limiting is occurring on the Input. (See "Limiters", page 19)
- 8) **Input Source**
Displays the selected input type. To change the input type, press the Headphone Encoder, turn it to make a selection, then press it again to confirm the selection. (See "Input Types", page 14)
- 9) **Headphone Source / Level**
Currently active Headphone Source. Displays monitor gain during adjustment. (See "Headphone Monitoring", page 22)
- 10) **L,R Bus Assignment**
Displays the status of the Input's assignment to the main Left and Right buses. Slide the RTN / FAV Switch to the right to toggle routing of Inputs 1, 2, and 3. Slide the RTN / FAV Switch to the left or right to toggle routing of Inputs 4, 5, and 6 to the Left or Right bus. Routed signal is indicated by a red background and unrouted signal by a black background. (See "Input Routing", page 14)
- 11) **Input Polarity**
Slide the RTN / FAV Switch left to toggle input polarity. Available on Input 2 only. (See "Polarity", page 17)
- 12) **Input Trim**
Displays the trim gain on inputs 4, 5, and 6 as well as any input with the source set to AES42 or AES3. Trim is adjusted on these Inputs by rotating the Select Encoder while viewing the Input Settings Screen. (See "Trim and Fader Relationship", page 15)

Routing Screens

Various Routing Screens are present in the 633 interface. A Routing Screen displays available source signals for routing destination tracks or outputs. An assigned route is indicated with a blue box and an unassigned route is indicated with a black box.

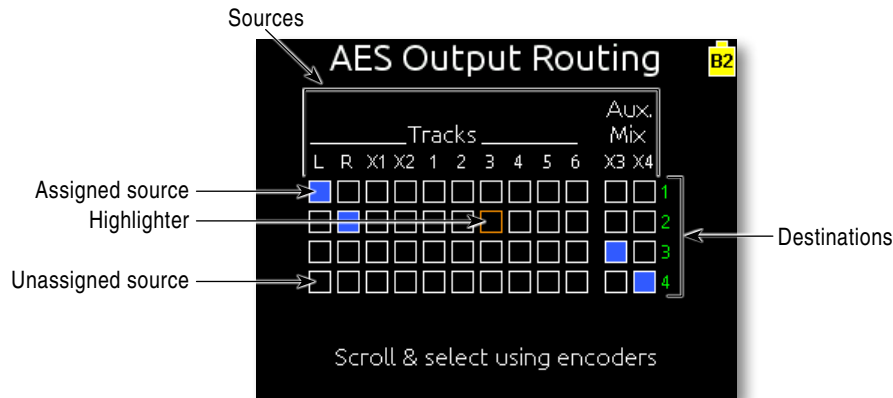

To edit routes in a Routing Screen:

1. Move the orange highlighter to the box to be edited. Rotate the Headphone Encoder to move the highlighter horizontally. In some Routing Screens, the Select Encoder will also move the highlighter vertically.
2. Press the Headphone Encoder to toggle the assigned state of the highlighted box.

On some Routing Screens, additional options are available and can be accessed with the Mic / Tone Switch or the RTN / FAV Switch. These options will be displayed directly above the respective switches.

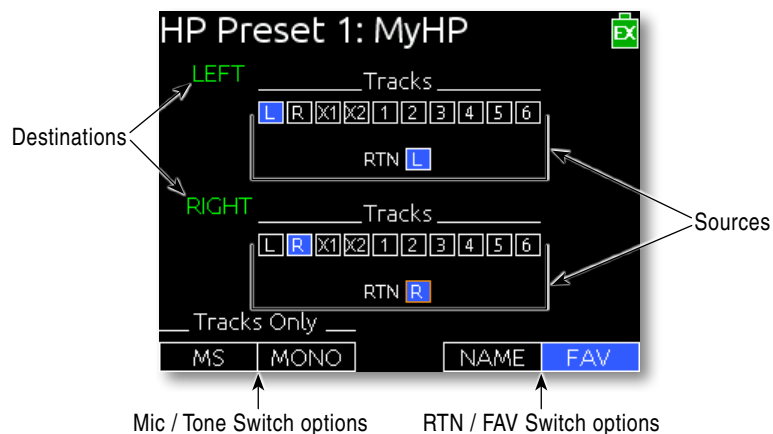

LCD Daylight Mode

When engaged, LCD Daylight Mode changes the color scheme of the user interface to be more easily viewable in environments with bright ambient light or direct sunlight. LCD Daylight Mode can be engaged from the Setup Menu option **SYSTEM > LCD Daylight Mode** or toggled quickly by pressing and holding the Headphone Encoder then pressing the Select Encoder.

Inputs

The 633 has three, full-featured audio inputs on XLR-3F connectors and three additional line-level inputs on TA3 connectors. Inputs can be used as either balanced or unbalanced connections. To unbalance, tie pin-3 to pin-1 of the XLR-3M connector of the cable. There is no change in gain between unbalanced and balanced connections into the 633.

Inputs are configured from their respective input Settings Screen. The default method for accessing the Input Settings Screen for inputs 1-6 is to slide the Input Select Switch toward the desired input number. This functionality can be altered when Setup Menu option **INPUTS > PFL Toggle Mode** is set to **3ch** (See “PFL Toggle Mode”, page 25).

Input Types

Change the input type from the Input Settings Screen (See “Input Settings Screen”, page 11).

The following table describes the available input types.

Input Type	Inputs Available	Description
OFF	All	Input off.
MIC	1, 2, 3	Use with dynamic microphones or other mic-level signals.
MIC-PH	1, 2, 3	Use with phantom-powered condenser microphones only. Provides 48V or 12V phantom power. see Phantom Power
LINE	All	For use with any line-level source.
LINE-PH	1, 2, 3	For use with phantom-powered condenser microphones only. Provides 48V or 12V phantom power, but at a line-level gain range. Useful for recording extremely loud sounds.
AES42	1, 2*	Digital input with power activated for AES42 (Mode 1) digital microphones.
AES3	1, 2*	Digital input.

* AES42 and AES3 input source option only appears in input 2 when selected as a source for input 1. Input 1 XLR-3F connector is used for digital input.

Input Routing

Each input of the 633 has a corresponding “ISO” Track that it is permanently routed to. Additionally, each Input can be independently routed to the Left (L), Right (R), Aux 1 (X1), and/or Aux 2 (X2) buses from the Input Settings Screen (See “Input Settings Screen”, page 11). Inputs are routed to the Aux 1 (X1) and Aux 2 (X2) buses from the X1, X2 Routing Screen (Setup Menu option **OUTPUTS > X1, X2 Routing**) and to the Aux 3 (X3) and Aux 4 (X4) buses from the X3, X4 Routing Screen (Setup Menu option **OUTPUTS > X3, X4 Routing**).

Input signals are always routed to L and R tracks post-fader. The Pan Control variably adjusts the level of Input 1, 2, or 3 signal to the L and R tracks. Input signals can be routed to ISO tracks and X1, X2, X3, and X4 tracks either pre- or post-fader.

- Pre- or post-fader routing to ISO tracks is set per channel from Setup Menu section **INPUTS > Input to ISO Routing**.
- Pre- or post-fader routing to X1 and X2 tracks is set from the Input Settings Screen. From the Input Settings Screen, slide the Mic / Tone Switch to cycle between unrouted (black background), routed post-fader (red background), and routed pre-fader (red background with **PRE** label).

- Pre- or post-fader routing to the X1, X2, X3 and X4 tracks is a global setting that applies to all inputs routed to the X1, X2, X3 and X4 tracks. This option is configured from the X1, X2 Routing Screen and the X3, X4 Routing Screen.

Pan Control

The pop-up Pan Control routes Inputs 1, 2, and 3 to the left (L) and right (R) channels of the stereo Master Bus. The pan pot has a detent in the center position. After setting the pan, the pan control can be recessed to hide it from the mixing surface during normal operation.

Inputs 4, 5, and 6 are routed directly to the left (L) and/or right (R) channels of the stereo Master Bus from their respective Input Settings Screens.

Trim and Fader Relationship

The gain of an input is adjusted by two controls, Input Trim and Input Fader. This two-stage architecture is identical to the topology of large mixing consoles and provides a great deal of control. Input Trim is often thought of as a coarse gain control and the Input Fader as the fine gain control.

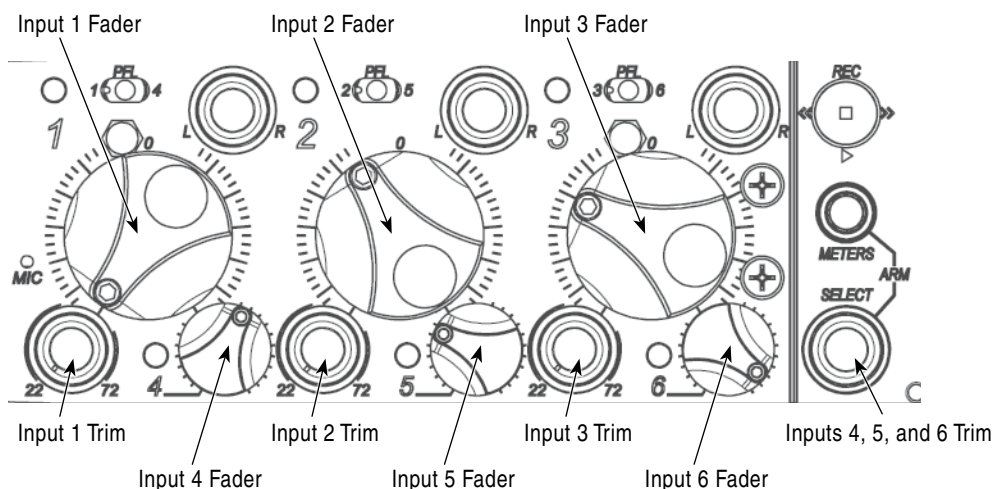

Input/Trim (Analog)

Analog input sensitivity for Inputs 1, 2, and 3 is set with the pop-up Trim control knob. Analog input sensitivity for line-level Inputs 4, 5, and 6 is set by rotating the Select Encoder from the respective input's Input Settings Screen (Off, -30 dB to 16 dB). To power down Input 1, 2, or 3 turn the respective trim control fully counter-clockwise until it clicks.

With the Input Fader set to unity gain (0 dB or 12 o'clock), make the appropriate adjustments to trim levels. Once the coarse gain is set to the desired level, press the Trim control to hide it from the 633's mixing surface.

Input Trim (Digital)

The coarse level of a digital input is set by rotating the Select Encoder in the Input Settings Screen of an input with a digital source. The digital trim level is displayed on the LCD. The digital trim level is adjustable from -30 to +16 dB.

Input Fader

The Input Fader is the primary control used while mixing and it affects the level of the Input signal routed to all post-fader destinations. Use the Input Fader to make fine gain adjustments. The fader can be attenuated from off (full counter-clockwise position), -36.8 dB to +16 dB (full clockwise position) relative to the set Trim level. To optimize gain structure for the best performance, operate input faders at or near the 0 dB (unity gain) position.

Inputs 1, 2, and 3 use the large fader knobs. Inputs 4, 5, and 6 use the pop-up fader knobs. To power down Input 4, 5, or 6, turn the respective pop-up fader control fully counter-clockwise until it clicks.

Phantom Power

Phantom power is enabled on an input during input type selection (See “Input Types”, page 14) (See “Input Settings Screen”, page 11).

Phantom powering is a fixed DC voltage of either 12 or 48 Volts. This voltage is resistively applied to pin 2 and pin 3 of an input’s XLR-3F connector, relative to pin 1. In this configuration, there is no voltage difference between signal pins 2 and pin 3.

The phantom voltage is selectable between 12 and 48 Volts from the Setup Menu item **INPUTS > Phantom Voltage**. The selected voltage level applies to all inputs with phantom power enabled. The factory default phantom power voltage is 48 V.

Digital Inputs

The 633 accepts AES3 (AES/EBU) balanced, AES42 (Mode 1) balanced, and AES3 unbalanced digital signals on the Input 1 XLR-3F connector. The 633 auto-detects between AES3 balanced and AES3 unbalanced digital signals and adjusts accordingly. Digital input gain is controlled by rotating the Select Encoder from the input’s Input Settings Screen.

Never attach unbalanced connections to an input set for AES42. This can result in damage to the hardware.

To use a digital input:

1. Enter the Input Settings Screen for Input 1. (Slide Input Select switch left or right depending on the value of Setup Menu option **INPUTS > PFL Toggle Mode**) (See “PFL Toggle Mode”, page 25)
2. Press the Headphone Encoder to display the list of available input sources.
3. Turn the Headphone Encoder to select **AES3** or **AES42**
4. Press the Headphone Encoder to confirm the selection.

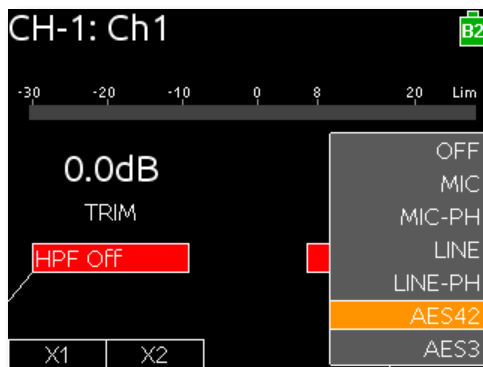

AES digital signal carries two channels of audio. When the source of Input 1 is set to AES42 or AES3, the first channel of the AES signal is present on Input 1 and the second channel of the AES signal is available on Input 2. Selecting AES42 or AES3 source for Input 2 will connect to the second channel of the AES signal (plugged into Input 1) and disable input 2's XLR-3F connection.

The 633's digital inputs are sample rate converted to the internal recorder's sample rate.

High-pass Filter

Each input channel has an adjustable High-pass Filter controlled by pressing the Select Encoder from the input's Input Settings Screen, rotating the Select Encoder to adjust the frequency, then pressing the Select Encoder again. To disable an input's High-pass Filter, rotate counter-clockwise until the value **HPF Off** is shown.

High-pass (or low-cut/low roll-off) filters are useful for removing excess low frequency energy from audio signals. Wind noise is a common unwanted low frequency signal that can be reduced with the use of a High-pass Filter. For most audio applications, engaging the High-pass Filter is beneficial, because audio information below 100 Hz is rarely used, especially for speech reproduction.

The 633's High-pass Filter circuit features an adjustable corner (-3 dB) frequency over a range from 80 to 240 Hz. Below 80 Hz, the filter's slope is 12 dB/octave. At higher corner frequency settings, the slope is 6 dB/octave. The purpose for this compound slope is to give additional roll-off at the 80 Hz setting to reduce wind noise and low frequency rumble. The higher settings can be used to counteract the proximity effect of directional microphones where a more gentle slope is desired.

The 633's High-pass Filter circuit is unique because of its placement before any electronic amplification. Most mixers' High-pass Filter circuits are placed after the microphone preamplifier, such that all of the low-frequency signals get amplified. By virtue of the 633's circuit cutting the low-frequency signals before amplification, higher headroom is achieved in the presence of signals with significant low-frequency energy.

When possible, attempt to equalize at the sound source with microphone selection, placement, wind screens, and onboard microphone filtering. Many microphones have on-board high pass filters. Use the High-pass Filters on the 633 in conjunction with the microphone's filter to increase the filter's slope.

*When Setup Menu option **RECORDER > Sample Rate** is set to **192k**, the High-pass Filter is not adjustable. The available options in this mode are **Off** and **50Hz**.*

Polarity

Change the polarity of Input 2 from the Input Settings Screen (See "Input Settings Screen", page 11).

Polarity reversal is used to compensate for incorrectly wired balanced cables, to prevent signal cancellation when a source is dual-miked from opposite directions, or to reverse left/right with microphones in a mid-side (M/S) configuration.

Input Linking

Input pairs 1-2 and 5-6 can be linked as stereo pairs. Inputs can be linked as a standard stereo pair or as an M/S matrixed stereo pair (See “M/S Matrixing”, page 18).

When a pair of inputs is linked:

- Each channels’ Trim Control and High-Pass Filter Control work as normal, controlling coarse gain and High-pass Filtering for their respective inputs.
- The odd channel’s Input Fader controls the post-fader level of both inputs.
- The odd channel’s Pan Control controls the balance of the stereo signal to the Master Bus. When linked M/S, the odd channel’s Pan Control functions as a left/right balance control for the matrixed M/S signal.
- The even channel’s Fader Control and Pan Control are disabled.
- The limiters of both inputs are linked.
- The background label of both inputs is connected on the Main Screen.



M/S Matrixing

When input pairs are linked M/S, the odd channel is used for the Mid signal and the even channel is used for the Side signal. To produce a stereo signal from an M/S configuration, the signal from both microphones must be processed.

Mid-side (M/S) matrixing is a method for processing audio signal from a cardioid microphone and a bidirectional microphone into a stereo signal. The cardioid microphone is the “mid” signal and connects to the odd Input, and the bidirectional microphone is the “side” signal and connects to even Input. The cardioid microphone is pointed at the sound source, and the bidirectional microphone is oriented sideways (positioned with its capsule as near as possible to the cardioid microphone’s capsule). The following diagram shows the relative polar patterns of microphones in an M/S configuration.

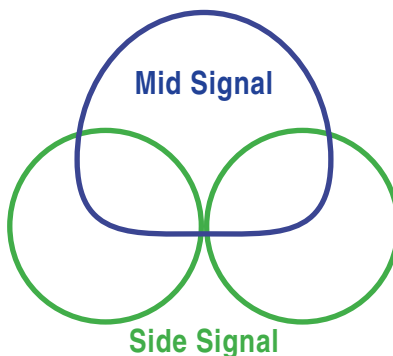

Limiters

Limiters prevent clipping by attenuating signals that surpass a set threshold. The amount of attenuation is defined by the “ratio” of the limiter and expressed as two numbers. All 633 limiters use a 20:1 compression ratio. This means that signal that exceeds the threshold by 20 dB will exit the limiting stage at only 1 dB above the threshold.

The time it takes for limiting to begin once signal has exceeded the threshold is referred to as the “attack time”. The time it takes for limiting to cease once signal has fallen back below the threshold is referred to as “release time”. Signals that exceed the threshold faster than the limiter’s attack time can still cause clipping. The 633 limiters have a 1 ms attack time and a 500 ms release time.

The limiters are globally activated when the Setup Menu item **LIMITERS > Limiter Enable** is set to **Hard Knee** or **Soft Knee** (See “*Limiter Knee*”, page 19). This activates both the input limiters (Inputs 1 through 6) and all output limiters. Sound Devices recommends using the limiters at all times. Limiters are present on both mic and line-level inputs as well as the Master L,R tracks and the X1,X2 tracks. The default threshold of all limiters is 16 dBu and can be adjusted from 4 dBu to 18 dBu (in 1 dBu increments) from Setup Menu options **LIMITERS > Input 1-6 PostFade Threshold**, **LIMITERS > L,R Threshold**, and **LIMITERS > X1,X2 Threshold**.

In normal operation, with a properly set gain structure, the threshold of the Input Limiter is rarely reached. Without Input Limiters, high signal conditions can overload a channel and cause distortion. The Input limiter is working when the respective input’s Input Activity LED illuminates yellow. Limiting activity will also be displayed as a yellow square on the right side of the input’s meter on the Main Screen. If the limiting activity is regularly indicating, reduce the amount of gain applied to the channel by turning down the Trim control.

Limiter Knee

The “knee” of the limiter determines how the limiter operates in relation to the set threshold. A “hard knee” leaves all program material below the threshold completely unaffected and attenuates only those peaks above the threshold. A “soft knee” attenuates the program material slightly before the threshold (about 6 dB) for a more gradual, tape-like sound.

The knee parameter for the 633’s limiters is set with Setup Menu option **LIMITERS > Limiter Enable**.

Linking Limiters

When two limiters are linked, both channels will be limited when signal reaches the threshold in any channel of the pair. Linking inputs as a stereo pair (see Input Linking) also links those inputs’ limiters. Limiters for L,R and X1,X2 channel pairs can be linked with Setup Menu options **LIMITERS > L,R Linking** and **LIMITERS > X1,X2 Linking**.

Metering

All track levels are displayed on the LCD in the Main Screen. A larger red square under the 20 dBU marker indicates clipping on the track. A large yellow square indicates limiting activity on the track.

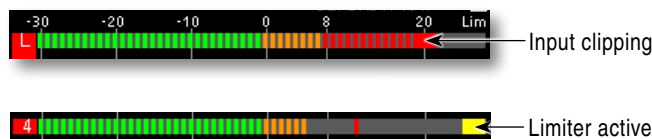

Meters can be displayed with segments or solid lines (Setup Menu option **SYSTEM > Meter Display Style**). Track Names can also be displayed on top of meters in various styles (Setup Menu option **SYSTEM > Track Names in Meters**). The following screen shots demonstrate solid meters and the available Track Name display styles.

Meter Appearance	Track Name Display Style
	OFF
	Left
	Left (w/ramp)
	Right

Meter Ballistics

Audio meter “ballistics” is the manner in which a visual meter responds to audio signal levels. The ballistics of all 633 meters is set globally from Setup Menu option **SYSTEM > Meter Ballistics**. The default ballistics setting is **Peak + VU**.

VU

VU (volume units) meter ballistics correspond closely to how the human ear perceives loudness. This provides a good visual indication of how loud a signal will be. In VU mode, the attack and decay of the meter signal is 300 mS. VU meters provide good visual indication of how loud a signal will be, but provide poor information of actual signal peaks.

Peak + VU

The 633 can simultaneously display VU and Peak level information. In this mode the perceived loudness (VU) is displayed as a standard bar, and the Peak signal as a single, independent segment above the VU.

Peak Only

Peak-reading ballistics (PPM) correspond to actual signal peaks, but don't necessarily correspond to perceived signal loudness. Peak meters have an instantaneous attack and a slow decay to allow visual monitoring of peak activity. Peak metering is useful when interconnecting to audio inputs on digital equipment. In the digital realm, signal overload can cause immediate distortion.

Peak Hold

When Peak Metering is enabled (Peak Only or Peak + VU), peak hold displays the last highest peak value on the meter as a separate, individual meter segment. By default this meter segment will remain visible for 1 second. This time can be adjusted from Setup Menu option **SYSTEM > Meter Peak Hold Time** to **1, 2, 3, 4, or 5** seconds. The **Infinity** option will display the last highest peak indefinitely until a higher peak is reached. The **Off** option will disable peak hold.

Input Activity LED

Each Input has its own Input Activity LED (See *“Front Panel”, page 1*). The LED illuminates in various colors and intensities to represent the signal level appearing at its respective input. Green = pre-fader signal activity, yellow = pre- and post-fader limiter activity, red = pre- and post-fader signal overload (clipping). Reduce the trim level control if the LEDs continuously illuminate yellow or red. The Input Activity LED will flash yellow when the Input PFL is latched. (See *“PFL (Input Solo)”, page 24*)

Headphone Clipping LED

The Headphone Clipping LED is located just left of the Headphone Encoder. This LED will illuminate red to indicate clipping in the headphone amplifier. Monitoring without a visual indication of headphone clipping can mislead the sound mixer into thinking that the output or return feeds are distorted.

Headphone Monitoring

Headphone Gain

By default, headphone output level is controlled by turning the Headphone Encoder while viewing the Main Screen or Input Settings Screen (See “Headphone Encoder Mode”, page 23). When adjusting the headphone gain, the gain value (in dB) is displayed in the lower right corner of the LCD. On the Main Screen and Input Settings Screen, this space displays the currently selected Headphone Source when the headphone gain is not being adjusted.

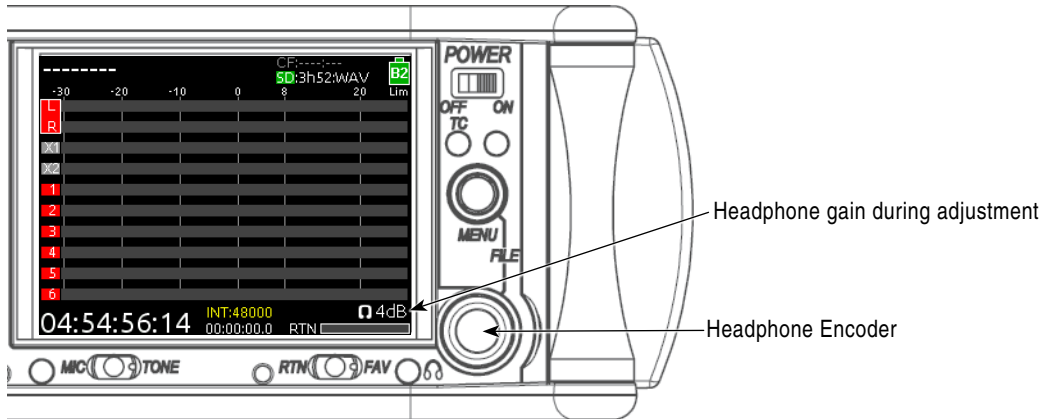

The 633 can drive headphones to dangerously high volumes. Turn down the headphone gain before selecting a Headphone Source to prevent accidental signal extremes.

Headphone Source Selection

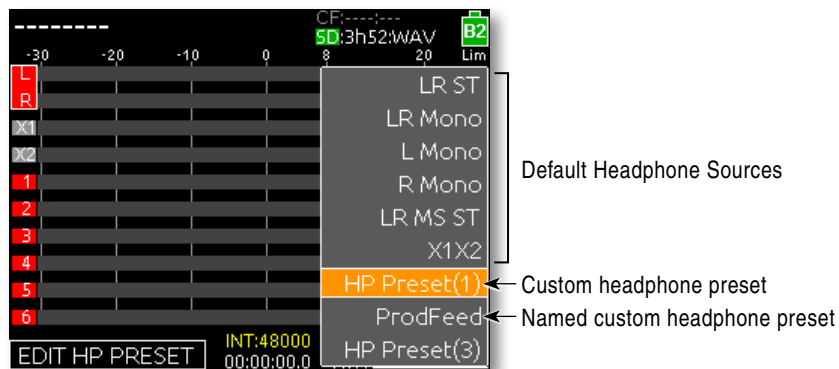

By default, to select the Headphone Source: Press the Headphone Encoder while viewing the Main Screen (See “Headphone Encoder Mode”, page 23). This will display the Headphone Source selection menu. Turn the Headphone Encoder to change the source, and press the Headphone Encoder to exit the menu (The menu will also exit automatically after 2 seconds of inactivity from the Headphone Encoder). The signal to the headphone outputs will immediately change as the Headphone Encoder is rotated and the selected Headphone Source will be displayed on the Main Screen in the lower left corner.

Headphone Source	Description
LR ST	Master Bus in stereo.
LR Mono	Master Bus summed mono to both ears.
L Mono	Left channel of Master Bus sent to both ears.
R Mono	Right channel of Master Bus sent to both ears.
LR M/S ST	Mid-Side Stereo - Master Bus decoded M/S stereo to headphones, this is not to be used if the inputs are already linked as an M/S pair.
X1X2	Aux Bus in stereo.
HP Preset	HP Presets 1-10 are customizable Headphone Sources. <i>See Headphone Presets</i>

Presets can be removed from the Headphone Source selection menu from Setup Menu option **SYSTEM > Headphone Preset List**.

Headphone Encoder Mode

The functions for selecting a Headphone Source and adjusting headphone gain can be switched by setting Setup Menu option **SYSTEM > Headphone Encoder Mode** to **Preset/Vol**. When this mode is engaged, turning the Headphone Encoder from the Main Screen will select Headphone Sources. To adjust the headphone gain from the Main Screen, press the Headphone Encoder and then turn the Headphone Encoder to adjust headphone gain. Turning the Headphone Encoder will continue to adjust gain until 2 seconds have elapsed with no gain adjustment, at which point turning the Headphone Encoder will once again select Headphone Sources.

Custom Headphone Presets

Ten custom Headphone Sources are available. These headphone presets can be edited, named and saved. To edit a custom headphone preset:

1. From the Main Screen, press the Headphone Encoder to access the Headphone Source List.
2. Rotate the Headphone Encoder to highlight the desired preset.
3. Slide the Slate/Tone Switch to display the Headphone Preset Editing Screen. This screen is a routing screen, with the left and right headphone signal labeled with green text. Sources with a blue background are assigned to that channel of the headphones, and sources with a black background are not assigned to the headphone channel.

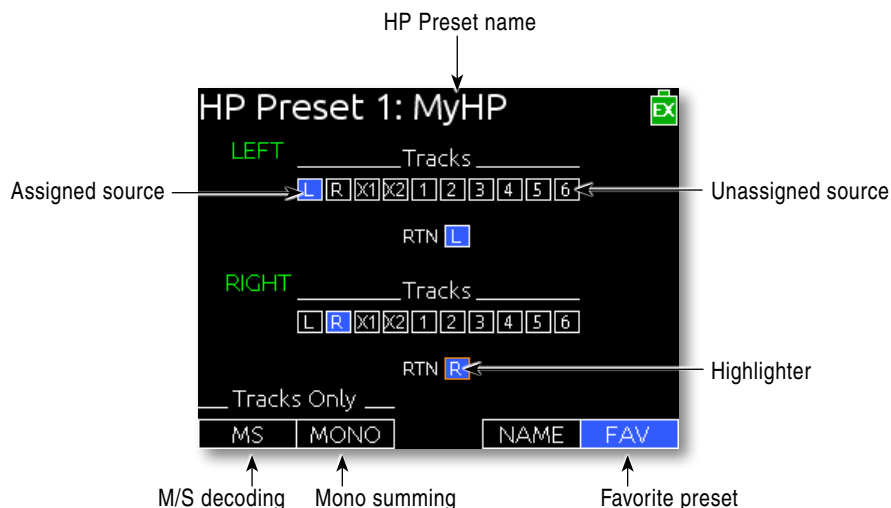

4. To toggle the assignment of a source, turn the Headphone Encoder to highlight the source and press the Headphone Encoder to toggle the assignment. Editing occurs in real time and source adjustments will be heard in the monitors.
5. (Optional) Slide the Slate/Tone switch left to toggle M/S decoding for the preset. M/S decoding will decode the entire preset and should not be used if inputs are already linked M/S.
6. (Optional) Slide the Slate/Tone switch right to toggle mono summing of the preset. Mono summing will ignore left and right assignment and put all active sources in both channels of the preset.
7. (Optional) To name a Headphone Preset, slide the RTN/FAV switch left and enter the name using the on-screen keyboard or attached USB keyboard.
8. (Optional) Slide the RTN / FAV Switch right to toggle this preset's Favorite status (See "*Favorite Headphone Source*", page 24). Press the Meters Button, Stop Button, or Select Encoder to exit the Preset Editing Screen.

Favorite Headphone Source

Any single Headphone Source can be set as the "favorite". The Favorite Headphone Source can be recalled quickly by sliding the RTN/FAV switch right from the Main Screen. To set a Default Headphone Source as the Favorite Headphone Source:

1. From the Main Screen, press the Headphone Encoder to access the Headphone Sources selection menu.
2. Highlight one of the default Headphone Sources (**LR ST**, **LR Mono**, **L Mono**, **R Mono**, **LR M/S ST**, or **X1X2**)
3. Slide the Slate/Tone switch left or right. The background of the **SET FAV** text on the LCD will become blue to indicate that the highlighted Headphone Source is now the Favorite Headphone Source.

Slide the RTN/FAV right in the Preset Editing Screen to set a Custom Headphone Preset as favorite. (See "*Custom Headphone Presets*", page 23).

PFL (Input Solo)

When any input's PFL is activated, the currently selected Headphone Source is replaced with the signal of the selected input (This signal will be pre- or post-fader depending on the input's setting in Setup Menu option **INPUTS > Input to ISO Routing**). The selected input's Activity LED flashes yellow when the input's PFL is engaged. Additionally, the PFL number will appear in the lower right corner of the Main Screen.

When Setup Menu option **INPUTS > PFL Toggle Mode** is set to **6ch** (default), entering the Input Settings Screen will also engage PFL for that input. Hold the Select Encoder while sliding Input Select Switch to display the Input Settings Screen without engaging PFL on the input.

When Setup Menu option **INPUTS > PFL Toggle Mode** is set to **3ch**, the Select Encoder and Input Select Switch are used together to access inputs 4, 5, and 6 PFL or Input Settings Screens. (See "*PFL Toggle Mode*", page 25)



PFL monitoring only affects the headphone monitor; It does not affect audio sent to the outputs or internal recorder.

Headphone Bells

The start of a recording can be indicated audibly by a single 440 Hz tone sent to headphones. When recording is stopped two 220 Hz tones can be sent to the headphones. The Record/Stop Bell can be enabled from the Setup Menu item **SYSTEM > Record/Stop Bell**. The Setup Menu option **SYSTEM > Warning Bell Level** allows adjustment of the level of the Record/Stop Bell.

PFL Toggle Mode

When Setup Menu option **INPUTS > PFL Toggle Mode** is set to **3ch**, the behavior of the Input Select Switches is altered. The following table describes 3ch PFL Toggle Mode functions. (See “Headphone Monitoring”, page 22)

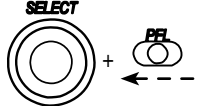
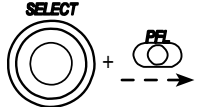
Button Action		Function
Input Select Switch left		PFL input 1, 2, or 3.
Input Select Switch right		Displays Input Settings Screen for input 1, 2, or 3.
Press and hold Select Encoder + Input Select Switch left		PFL input 4, 5, or 6.
Press and hold Select Encoder + Input Select Switch right		Displays Input Settings Screen for input 4, 5, or 6.

RTN Monitoring

The RTN Input can be monitored quickly by sliding the RTN/FAV switch left. The Monitor Mode **RTN** will be displayed on the Main Screen in the lower left corner. In Meter Views (See “Meter Views”, page 10) that do not include a large RTN meter, a smaller RTN meter is displayed directly under the Headphone Source:



The RTN level can be padded from 0 dB down to -30 dB. To adjust the RTN level:

1. Ensure that one of the chosen Meter Views in Setup Menu option **SYSTEM > Meter Options** includes “**RTN**”.
2. Press the Meters Button until a Meter View appears that displays the RTN meters.
3. Rotate the Select Encoder to highlight the RTN meter label.
4. Press the Select Encoder. The background of the RTN meter label will become orange to indicate that level adjustment mode is accessed. This level adjustment mode will automatically end if the Select Encoder is not rotated before 2 seconds.
5. Rotate the Select Encoder to adjust the RTN level. The dB value will be displayed in the lower right corner of the LCD during adjustment.
6. Press the Select Encoder again, or simply wait 2 seconds. The background color of the RTN meter label will become grey to indicate exit from level adjustment mode.

Output Setup and Control

Master Outputs (XLR-3M)

Master Left (L) and Right (R) analog signal output is provided on a pair of balanced XLR-3M connections. Each output can be independently set to Line (+4 dBu nominal), -10, or Mic level (40 dB of attenuation versus Line) from the Setup Menu options **OUTPUTS > XLR-L Out** and **OUTPUTS > XLR-R Out**. The master outputs are capable of driving long cable runs.

When set to output analog signal, the Master XLR-3M Outputs always carry the L and R bus signal, respectively. Signal is routed to the L and R buses from each inputs' Input Settings Screen by sliding the RTN / FAV Switch left or right. Both the Left (L) and Right (R) XLR-3M outputs can be independently set to provide AES digital signal. Various sources can be routed to AES Digital Outputs. (See *"AES3 Digital Outputs (XLR-3M)"*, page 27)

AUX 1/2 Outputs (TA3)

AUX 1 (X1) and AUX 2 (X2) analog signal output is provided on a pair of balanced TA3 connections. Each output can be independently set to Line (+4 dBu nominal), -10, or Mic level (40 dB of attenuation versus Line) from the Setup Menu options **OUTPUTS > TA3-X1 Out** and **OUTPUTS > TA3-X2 Out**.

Signal can be quickly routed to the X1 and X2 buses from each inputs' input Settings screen by sliding the Mic / Tone Switch left or right.

Signal can also be routed to the X1 and X2 buses from the X1, X2 Routing Screen (See *"Routing Screens"*, page 13). The X1, X2 Routing Screen is accessed from Setup Menu option **OUTPUTS > X1, X2 Routing**. ISO tracks or L and R tracks can be routed individually to X1 and X2 buses (routing any ISO track to a bus will unroute tracks L and R to that bus and routing L or R to any bus will unroute any ISO tracks to that bus).

Highlight the routing and press the Headphone Encoder to adjust the routing between off (black), post-fade (Blue), or pre-fade (Green). L and R tracks can only be routed post-fade. Selecting the **All ISO Tracks** option on this routing screen will change all active X1, X2 routes to pre- or post-fade.

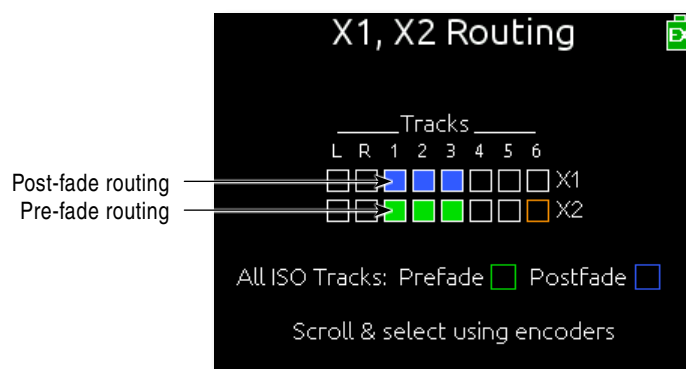

AUX 3/4 Outputs (TRS)

AUX 3 (X3) and AUX 4 (X4) analog signal output is provided on a single, 3.5 mm, TRS connection. This connection is wired unbalanced with Tip: X3 positive, Ring: X4 positive, Sleeve: Shared ground.

Signal is routed to the X3 and X4 buses from the X3, X4 Routing Screen (See *"Routing Screens"*, page 13). The X3, X4 Routing Screen is accessed from Setup Menu option **OUTPUTS > X3, X4 Routing**.

L, R, and ISO track routings to X3 and X4 can be set to pre- or post-fader. This setting is independent of the values set in Setup Menu option **INPUTS > Input to ISO Routing**. The **All ISO Tracks** option on this routing screen globally applies pre- or post-fade status to all ISO track routings to X3 and X4.

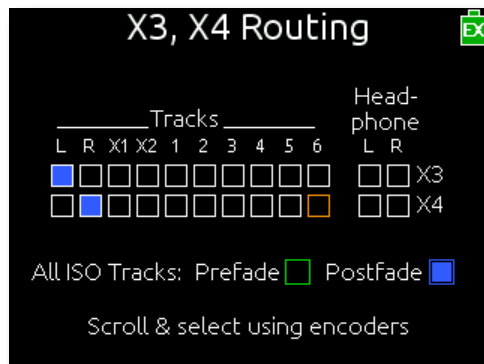

The Headphone Source in the X3, X4 Routing Screen is a special source which is a copy of the active Headphone Source. Changing the Headphone Source will change the Headphone L and Headphone R sources routed to X3 and/or X4 (See [“Headphone Source Selection”](#), page 22). This feature is useful for sending a copy of the monitor signal to a boom operator or other production members.

RTN signal can not be routed to X3 and X4 buses. When Headphone signal is routed to X3 or X4 and RTN signal is routed to the headphone preset, RTN signal will be present in the headphone output but not in X3 or X4.

AES3 Digital Outputs (XLR-3M)

There is a total of 4 available channels of digital output on 2 connections. Each of the XLR-3M outputs can be configured to output AES3 digital signals from the Setup Menu options **OUTPUTS > XLR-R Out** and **OUTPUTS > XLR-L Out**.

Any track can be routed to any AES output in any combination. ISO Tracks are routed to AES outputs pre- or post-fader depending on the Input's setting in Setup Menu section **INPUTS > Input to ISO Routing**.

Signal is routed to the AES outputs from the AES Output Routing Screen (See [“Routing Screens”](#), page 13). The AES Output Routing Screen is accessed from Setup Menu option **OUTPUTS > AES Output Routing**.

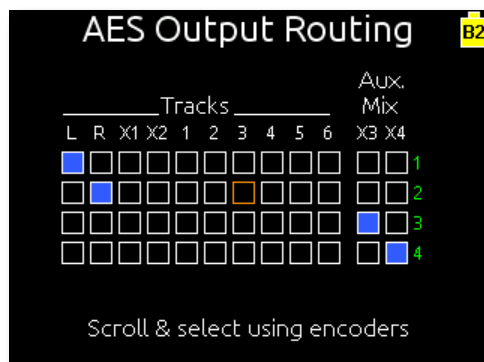

Adjusting Output Levels

The nominal level of analog outputs can be adjusted from Setup Menu options **OUTPUTS > XLR-L Out**, **OUTPUTS > XLR-R Out**, **OUTPUTS > TA3-X1 Out**, and **OUTPUTS > TA3-X2 Out**. The available options are **Mic**, **Line**, and **-10**.

The master level of L, R, X1, X2, X3, and X4 buses can be adjusted in 1 dB increments from 0 dB down to -30 dB / Off. To adjust the bus levels of L, R, X1, X2, X3, or X4 buses:

1. Press the Meters Button repeatedly until a Meter View is displayed that includes the output to be adjusted.
2. Rotate the Select Encoder to highlight the meter label of the output to be adjusted.
3. Press the Select Encoder. The background of the output's meter label will become yellow to indicate that level adjustment mode is accessed.
4. Rotate the Select Encoder to adjust the level. The dB value will be displayed in the lower right corner of the LCD during adjustment.
5. Press the Select Encoder again, or wait 2 seconds. The background color of the meter label will become grey to indicate exit from level adjustment mode.

Output level adjustments do not affect tone signal from the 633's tone generator.

Slate Mic and Tone Oscillator



The 3-position Mic / Tone Switch controls both the slate microphone and the tone oscillator.

Slate Microphone

The 633's built-in slate microphone is used to notate scenes from the mixer location. Its audio performance is not suitable for critical recording applications; it should be used for documenting scenes and for communication purposes only.

Slide the Mic / Tone Switch left to activate the slate mic. The green Slate Mic LED will illuminate to indicate that the slate mic is active. Slide the Mic / Tone Switch left again to deactivate the slate mic. Hold the Mic / Tone Switch left for 1 second to activate the slate mic momentarily (until the switch is released).

Tone Oscillator

Slide the Mic / Tone Switch right to activate the tone oscillator. Hold the Slate / Mic Switch right for more than 1 second to lock the tone oscillator on. When the tone oscillator is locked on, slide the Slate / Mic Switch right again to deactivate. The Slate Mic / Tone LED will illuminate green to indicate tone is activated.

Default tone is a continuous 1000 Hz sine wave at a level of 0 dBu. These parameters can be changed with Setup Menu options **SYSTEM > Tone Level** (0 dBu - 20dBu in 1 dB increments) and **SYSTEM > Tone Frequency** (100 Hz - 10,000 Hz in 10 Hz increments).

Hold down the Select Encoder while sliding the Mic / Tone Switch right to cause tone level to "pulse" in the L channel (to assist in identifying channels). This pulsing behavior can be made the default (so that the Select encoder does not need to be held down) by setting Setup Menu option **SYSTEM > Tone Mode** to **L Ident**.

Routing Slate and Tone Signals

By default, the slate microphone is routed to L, R, X1, X2, X3 and X4. By default, the tone oscillator is routed to all tracks and outputs. Slate and tone signal is routed to any combination of L, R, X1, X2, X3, X4, 1, 2, 3, 4, 5, and 6 from the Slate and Tone Routing Screen (See "Routing Screens", page 13). The Slate and Tone Routing Screen is accessed from Setup Menu option **SYSTEM > Slate & Tone Routing**:

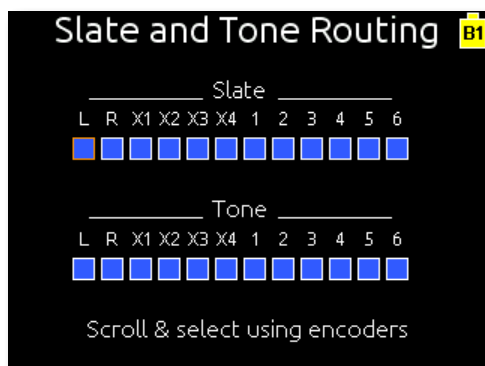

When the slate mic or tone oscillator is activated, program audio is muted on the destinations they are routed to and replaced with slate or tone signal.

Slate signal is always sent to both headphone channels. Tone signal is always sent to both headphone channels, unless the current Headphone Source is **RTN**. This is to allow calibrating levels with another device (A camera, for example) by monitoring output signal of the device while sending the 633's tone to that same device.



Slate signal is not present on AES digital outputs.

Recorder Setup and Control

The 633 features a powerful multi-track digital audio recorder. The internal recorder can record up to 10 tracks to mono or poly Broadcast WAV files or 2 tracks of compressed MP3 audio (See *"File Format"*, page 39). Data is written to removable CompactFlash (CF) and SD/SDHC/SDXC (SD) cards. (See *"Recording Media"*, page 35)

Transport Control (Recording and Playback)

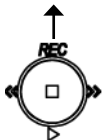
The 5-position Transport Control is used to perform all recording and playback functions. The 633 is a record-priority device. Pressing Record or Play from any screen will begin recording or playback.

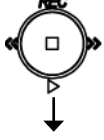
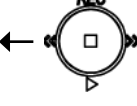
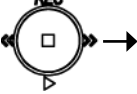
Function	Direction	Action
Record		Tilt the Transport Control Up Begins recording a new file.
Pause / Stop		Press the Transport Control During Record, press once to stop recording. During Playback, press once to pause, press again to stop. In standby, hold to display next take name.
Play		Tilt the Transport Control Down Begins playback of the last file recorded or file currently loaded. (See <i>"Playback"</i> , page 37)
Rewind/ Load Previous Take		Tilt the Transport Control Left While in Stand-by, tilt left to load the previous take. While in playback, tilt and hold left to rewind.
Fast Forward/ Load Next Take		Tilt the Transport Control Right While in Stand-by, tilt right to load the next take. While in playback, tilt and hold right to fast forward.

Recording Tracks

Each input of the 633 has a corresponding "ISO" Track that it is permanently routed to. The routing of ISO Tracks 1-6 can be adjusted to pre- or post-fader (See *"Input Routing"*, page 14). Four additional record tracks are available which correspond to the stereo Master Bus (L,R) and the stereo Aux Buses (X1,X2.)

Track Arming

The armed status of a track is indicated on the Main Screen with a red background in the track label. An unarmed track label's background will be grey.

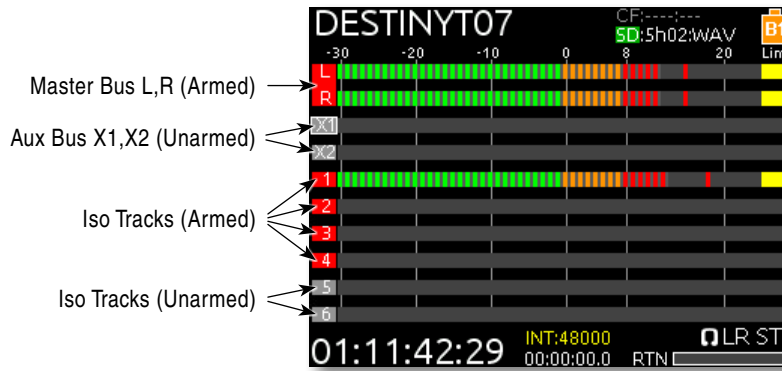

To toggle the armed status of a track, turn the Select Encoder to highlight the track, press and hold the Meters Button, then press the Select Encoder. The background color of the track will change to indicate the new arming status. If an input is off (Trim 1-3 Control fully counter-clockwise, Fader 4-6 fully counter-clockwise, or Input Selection set to Off), the track label will be black.

Track-to-Media Routing

The 633 supports simultaneous recording to CF and SD media (See “Recording Media”, page 35). By default, all armed tracks are recorded to both cards as a polyphonic WAV file. Recording options are set independently for each memory card from the Setup Menu items **RECORDER > Record to CF** and **RECORDER > Record to SD**. Each item can be set to the following settings:

Setting	Tracks Recorded	File(s) Generated
Off	None (0 tracks)	No file
Wav Poly	All armed tracks (0-10 tracks)	Polyphonic WAV file
Wav Poly (ISOs only)	Armed ISO tracks (0-6 tracks)	Polyphonic WAV file
Wav Poly (LR only)	Armed L and R tracks (0-2 tracks)	Polyphonic WAV file
Wav Poly (X1X2 only)	Armed X1 and X2 tracks (0-2 tracks)	Polyphonic WAV file
MP3 (LR)	Armed L and R tracks (0-2 tracks)	2-track MP3 file
MP3 (X1X2)	Armed X1 and X2 tracks (0-2 tracks)	2-track MP3 file
Wav Mono	Armed Tracks (0-6 tracks)	Mono WAV files
Wav Mono (ISOs only)	Armed ISO Tracks (0-10 tracks)	Mono WAV files

Track-to-Media routing also determines the file and digital audio format. Selecting WAV or MP3 in these Setup Menu options will result in WAV or MP3 files to be written during recording. (See “Digital Audio Format & File Format”, page 34)

Track Naming

Track Names are stored in the metadata of each recorded file. The following list displays the default track names:

- Track L: MixL
- Track R: MixR
- Track X1: Aux1
- Track X2: Aux2
- Track 1: Ch1
- Track 2: Ch2
- Track 3: Ch3
- Track 4: Ch4
- Track 5: Ch5
- Track 6: Ch6

Track Names of previously recorded files and track names of all subsequently recorded files can be edited. Tracks can be renamed from the Setup Menu or the Input Settings Screen.

To rename tracks from the Input Settings Screen:

1. Enter the Input Settings Screen of the Track to be renamed. The method for doing this depends on the setting of Setup Menu option **INPUTS > PFL Toggle Mode**.
2. From the Input Settings Screen, Slide and hold the Input Select Switch in the same direction used in step 1 and hold it for 1 second. If renaming tracks 4, 5, or 6 with **INPUTS > PFL Toggle Mode** set to **3ch**, hold down the Select Encoder while sliding the Input Select Switch.
3. Using the on-screen keyboard or attached USB keyboard, enter the Track's name.
4. Slide the RTN / FAV Switch right to accept the changes.

To rename tracks from the Setup Menu:

1. Enter the Take List (Press and hold the Menu Button then press the Headphone Encoder or **FILE STORAGE > Take List**)
2. To edit track names of subsequently recorded files, rotate the Headphone Encoder to highlight the next take (indicated by orange text and the phrase "[next]"). To edit the track names of a previously recorded take rotate the Headphone Encoder to highlight that take.
3. Slide the RTN / FAV Switch to enter the take's Metadata Edit screen.
4. Rotate the Headphone Encoder to highlight the Track to be edited, then push the Headphone Encoder to edit that track's name.
5. Rotate the Headphone Encoder to select a Track Name from the list. If the desired Track Name is not in the list, scroll to the bottom of the list and select **<Add New Entry>**.

The list of track names is a single list that is shared between all tracks. The list can contain 70 Track Names. When the list reaches 70, old Track Names must be deleted before adding new Track Names. To reset the Track Name list to defaults, choose **<Load Default List>** from the Track Name list in the Metadata Edit screen. Note, This will reset the Track Name list for all tracks no matter which track was selected in the Metadata Edit screen.

Track Names can be displayed on the Meters of the Main Screen. To enable track names on the meters, select one of the Track Name display styles in Setup Menu option **System > Track Names in Meters**. The following screen shots illustrate the available Track Name display styles.

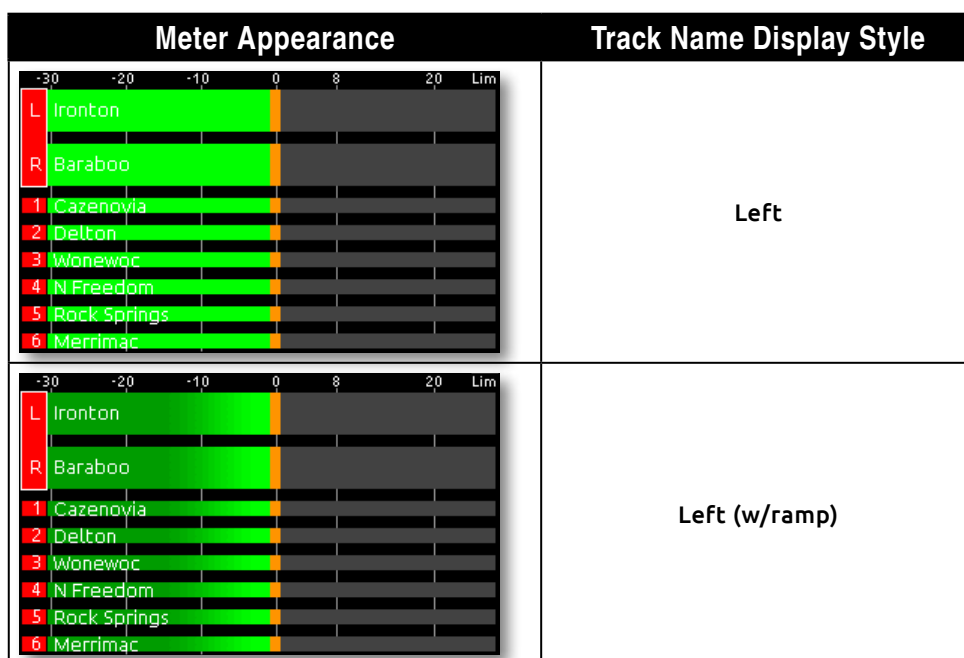

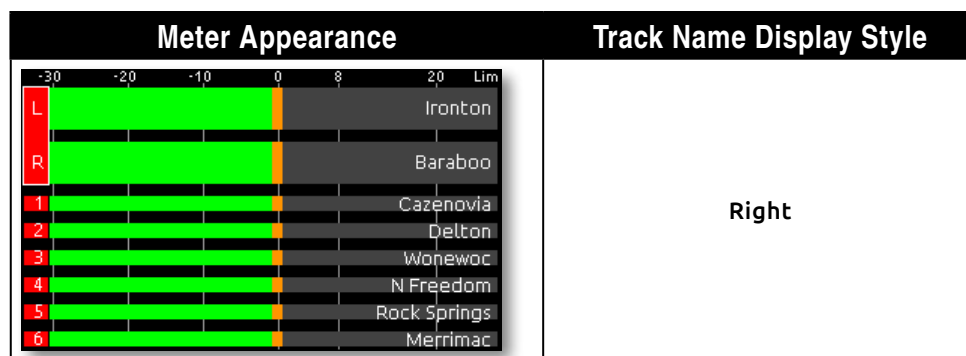

Digital Audio Format & File Format

Two digital audio formats are available on the 633: Uncompressed PCM (WAV) and compressed MPEG Layer III (MP3). Uncompressed PCM audio is stored in a WAV file format and compressed MPEG audio is stored in an MP3 file format. The WAV format is used for projects where audio quality is critical. The MP3 format is typically used for projects where audio quality is not as critical as storage space (When recording speech for transcription, for example).

Feature	WAV	MP3
Maximum track count	10	2
Available recording Tracks	L, R, 1, 2, 3, 4, 5, 6, X1, X2	L, R or X1, X2
Allowed sample rates	All	44.1 kHz or 48 kHz
Metadata	Complete metadata support per Broadcast Wave File (BWF) standard.	Limited metadata support.
Audio data	Uncompressed	Compressed
Storage space used	7.6 MB - 33 MB per track, per minute Dependant on sample rate	500 KB - 1.2 MB per track, per minute Dependant on MP3 Bit Rate

WAV (Broadcast WAV) File Format

The 633 writes AES-31 Broadcast Wave formatted files. The audio files created by the 633 include additional information (Metadata) in the file's header, bEXT (Broadcast Audio Extension) and iXML data chunks (See *"Metadata Fields"*, page 41). Software that does not recognize these additional broadcast wave data chunks will simply ignore them.

MP3 File Format

MPEG Layer III is a lossy compression algorithm, often used for transcription recording purposes. The 633 records two-channel MP3 audio files with data rates of 320 kb/s, 192 kb/s, or 128 kb/s.

MP3 files do not utilize the any standard container format. No industry-standard tagging format has defined for the MP3 file format. The 633 utilizes the de facto standard ID3v1 tagging format to store relevant metadata. (See *"Metadata Fields"*, page 41)

MP3 Bit Rate

When recording MP3 files, the 633 (and all other MP3 encoders) compresses data to achieve a particular bit rate. The bit rate refers to how many bits of data per second are encoded into the MP3 file. A larger bit rate yields a larger file with higher audio quality while a smaller bit rate yields a smaller file with lower audio quality. To adjust the bit rate of recorded MP3 files, access Setup Menu option **RECORDER > MP3 Bit Rate**. The 633 records two-channel MP3 audio files (See *"Track-to-Media Routing"*, page 32) with data rates of 320 kb/s, 192 kb/s, or 128 kb/s.

Sample Rate

The 633's digital audio recorder can record digital audio in the at the following sampling rates:

- 44.1 kHz
- 47.952 kHz
- 47.952 kHz "F" (files stamped 48 kHz)
- 48 kHz
- 48.048 kHz
- 48.048 kHz "F" (files stamped 48 kHz)
- 88.2 kHz
- 96 kHz
- 192 kHz

The sampling rate is set from Setup Menu item **RECORDER > Sample Rate**. The current Sample Rate is displayed on the Main Screen. All digital input signal is sample rate converted to the 633's sampling rate.

When recording MP3 to any media (See "*Track-to-Media Routing*", page 32), sample rate is restricted to 44.1 kHz or 48 kHz. A warning dialog will appear when attempting to record MP3 at an incorrect sample rate and recording will be prevented.

Bit Depth

When recording WAV files, the 633 records either 16 or 24 bit files. The bit depth for recorded WAV files is set from the Setup Menu option **RECORDER > Bit Depth**.

Bit depth defines the digital "word length" used to represent a given sample and correlates to the maximum dynamic range that is represented by the digital signal. Larger bit depths accommodate more dynamic range. Sound Devices recommends 24-bit recording for all critical production.

Recording Media

The 633 records to approved removable CompactFlash (CF) and SD/SDHC/SDXC (SD) cards. The 633 can write to one or both of these cards at the same time. Visit www.sounddevices.com/approved for an up-to-date list of tested and approved cards.

The SD card is inserted with the bottom of the card (the side with metal contacts visible) facing toward the rear of the 633. Press until it clicks. To remove, push in again to release the spring-loaded connector, then pull the SD card out.

The CF card is inserted with the top of the card (the side with the manufacturer's branding label) facing the rear of the 633. The final few millimeters of insertion require light force. To remove the CF card, grip it firmly and pull it out.

If the CF card is oriented correctly, it will slide in easily until only a few millimeters are protruding. If the CF card is oriented incorrectly, it will slide in easily until over 1 cm of the card is still protruding, at which point it will not slide anymore and further pressure could damage the CF slot.

Formatting Media

Before recording to CF or SD media, cards must be formatted. To format cards in the 633:

1. Press the Menu Button to enter the Setup Menu.
2. Turn the Headphone Encoder to highlight **FILE STORAGE**, then press the Headphone Encoder to enter the **FILE STORAGE** section.
3. Turn the Headphone Encoder to highlight **Erase/Format CF** or **Erase/Format SD**, then Press the Headphone Encoder to begin the formatting process.

Media can also be formatted from the File List Screen by highlighting the desired media, sliding the RTN / FAV Switch left or right, then selecting Erase/Format from the available options.

The 633 uses the FAT32 file system for all cards 32 GB or less in capacity. Cards with a capacity greater than 32GB are formatted with the exFAT file system. FAT32 and exFAT are compatible with all current major operating systems.

The exFAT file system is not compatible with Windows XP or Mac OS X 10.6.4 or lower.

Pre-Roll

To prevent missing record cues or up-cutting takes, the 633 has pre-roll buffering available. When active, pre-roll begins recording at a set number of seconds **preceding** the record command. The Pre-Roll time can be adjusted from 0 to 6 seconds the Setup Menu option **RECORDER > Pre-Roll Time**. Maximum pre-roll time is reduced in the following conditions:

- When recording mono WAV files to any media: 3 second maximum pre-roll time.
- When **RECORDER > Sample Rate** is set to **88.2k** or **96k**: 3 second maximum pre-roll time.
- When **RECORDER > Sample Rate** is set to **192k**: 1 second maximum pre-roll time.
- Pre-Roll is disabled when the timecode mode is set to **Record Run**, **External Timecode Auto Record**, or **External Timecode Continuous Auto Record**. This prevents possible overlapping timecode numbers between adjacent files.

“F Mode” Sample Rates

48.048k and 48.048kF

The 48.048kF mode (F stands for “fake”, “faux”, or “Fostex”) is a specific compatibility mode for use with the Fostex DV40 software (1.74 and previous), Avid, Final Cut Pro, and other post-production environments that do not recognize audio files written at 48.048 kHz. In this mode files are recorded at a 48.048 kHz sampling rate but are stamped at 48 kHz. When played, they will play back 0.1% slower than real time.

One use for the 48.048kF mode is to force a 0.1% speed reduction (pull down) of audio to match MOS-telecined film (24 fps-to-NTSC) in non-linear edit systems, such as Avid or Final Cut Pro. Since the file is stamped as a 48 kHz file, the edit system will play it back at 48 kHz and not at 48.048 kHz. This “audio pull down” will match the transferred picture without the need for an intermediate step through other software to create the pull down.

When using 48.048kF sample rate, set Setup Menu option **TIMECODE > Frame Rate** to **30ND** or **24**. When set to **30ND**, files will be stamped with a frame rate of 29.97. When set to **24**, files will be stamped with a frame rate of 23.97ND.

Fostex DV40

When using files recorded in the 48.048kF mode with a DV40 with early software, set the DV40 timecode frame rate to 29.97ND. Timecode stamps will properly match the original timecode start times.

47.952k and 47.952kF

Both 47.952 and 47.952kF settings use a record sampling rate of 47.952 kHz, 0.1% lower than 48 kHz. The 47.952kF mode, however, identifies the file as being recorded at 48 kHz.

When using 47.952kF sample rate, set Setup Menu option **TIMECODE > Frame Rate** to **23.97ND** or **29.97ND**. When set to **23.97ND**, files will be stamped with a frame rate of 24. When set to **29.97ND**, files will be stamped with a frame rate of 30ND.

MP3 recording is not allowed in "F Mode".

Playback

The 633 can play back any file it has recorded. To play back the last file recorded or loaded, press the Play Button. In the Take List or File List, pressing the Play button will initiate playback of the highlighted take.

When playback begins, the file name will be displayed on the Main Screen with a green background. The time code and absolute time areas of the Main Screen will display the time code and absolute time of the file being played back. Pressing the Stop button will pause playback, and pressing the Stop button when playback is paused will stop playback.

The media that files will be played back from is highlighted with a green background on the Main Screen and RTN Screen. To toggle the default playback card, press and hold the Headphone Encoder then press the slide the Transport Control down (Play).

By default, playback will be routed to all outputs of the 633. To limit playback to headphone outputs only, set Setup Menu option **OUTPUTS > Playback to Outputs** to **Headphones Only**. During playback, Input PFL switches will solo the respective ISO track of the playing file to the headphone output.

WAV files recorded on the 633 will play back to tracks as they were recorded. MP3 files recorded on the 633 will always play back to the L and R tracks.

File Management

The 633 writes files to both CompactFlash (CF) and Secure Digital (SD) storage media. Storage media must be formatted prior to use with the 633. CF and SD storage media inserted into the 633 can be formatted with Setup Menu option **FILE STORAGE > Erase/Format CF** and **FILE STORAGE > Erase/Format SD** respectively. The 633 formats cards of 32 GB or less with the FAT32 file system. Cards with a capacity greater than 32 GB are formatted with the exFAT file system. To manage files on 633 media using a computer, simply remove the media from the 633 and insert into a compliant CF or SD card reader connected to a computer.

The exFAT file system is not compatible with Windows XP or Mac OS X 10.6.4 or lower.

Visit www.sounddevices.com/approved for an up-to-date list of tested and approved cards.

File List

The File List displays all files on the CF or SD card. To access the File List, select Setup Menu option **FILE STORAGE > File List**. The File List can also be accessed by sliding the Slate/Tone Switch left or right while viewing the Take List. When entering the File List, the first view is the Root Menu:



In the Root Menu of the File List, use the Headphone Encoder to highlight either the CF or SD card. Slide the RTN / FAV Switch to access options for the highlighted card. Press the Headphone Encoder to display the listing of files and directories on the highlighted card.

When audio files are highlighted, various metadata information is displayed for that file on the right half of the display.

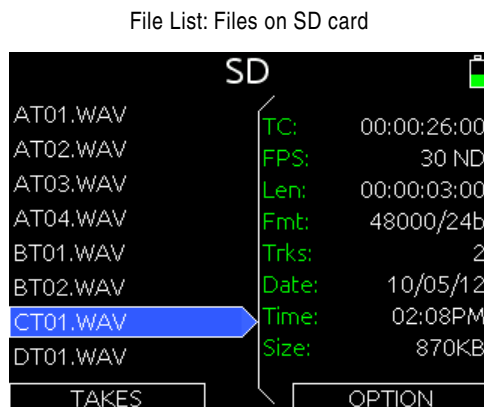

Slide the RTN / FAV Switch to access File Options for the highlighted file, directory, or storage media. The following table lists the File Options that are available for files, directories, and storage media:

File Option	File	Directory	Storage Media
Copy	Copies file to the other storage media.	Copies directory and its contents to the other storage media.	Copies all files and directories to the other storage media.
Delete	Deletes file.	Deletes directory and its contents.	
Create Sound Report		Creates a CSV sound report of all files in the directory and saves the report there.	Creates a CSV sound report of all files in the root of the storage media and saves the report there.
Rename		Changes the name of the directory.	Changes the volume label of the storage media.
Empty Trash		<i>Available only on TRASH and FALSETAKES directories. Deletes the contents of the folder.</i>	Deletes the contents of the TRASH directory on the storage media.
Erase/Reformat			Formats the storage media.

File Format

The 633 records audio to the industry-standard Broadcast Wave file format. Additionally, the 633 can record to MP3 format. Recording WAV or MP3 is selectable per media, from the Setup Menu items **RECORDER > Record to CF**, and **RECORDER > Record to SD**. The 633 can write files to both cards simultaneously. (See “Digital Audio Format & File Format”, page 34)

File Structure

The 633 records polyphonic or monophonic audio files. A polyphonic take consists of one file with multiple tracks, whereas a monophonic take consists of one file for each track, per take.

A polyphonic take and file name consists of a scene name, take number, and a file extension. For example, for scene S01, take T01, the polyphonic file name and take name are both *S01T01.wav*.

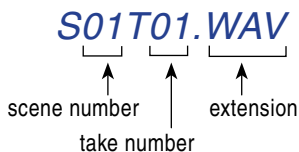

A monophonic take name is the same as a polyphonic take name, however the file name of each track differs slightly. Each file (track) of a monophonic take is named with the take name, followed by an underscore character (“_”), followed by the track *designator*.

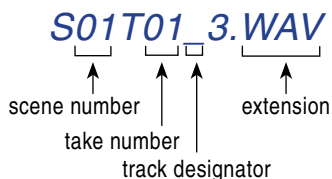

Note that the track *designator* is not the same as the track name on the 633:

- The **track name** on the 633 is indicated on the Input Settings Screens and meters and is stored in the iXML and bEXT metadata of each file.

- The **track designator** differs in order to maintain proper interleave order of the tracks. It is used in the file name of each mono file of a mono take.
- The **channel number** is another designator stored in the iXML and bEXT metadata of each file and is similar to the track designator, except that AUX tracks have numeric channel numbers.

The following table shows the association between track names, track designators, and channel numbers.

Track	Track Name	Track Designator	Channel Number
Track L	MixL	1	1
Track R	MixR	2	2
Track 1	Ch1	3	3
Track 2	Ch2	4	4
Track 3	Ch3	5	5
Track 4	Ch4	6	6
Track 5	Ch5	7	7
Track 6	Ch6	8	8
Track X1	Aux1	F	15
Track X2	Aux2	G	16

X1 and X2 are interleaved as 15 and 16 to ensure compatibility with the 664.

Folder Options

All files generated by the 633 can be saved to the Root directory, a Project Folder, a Daily (Roll) Folder, or a Scene Folder (Files are saved to the Root directory by default). File organization is managed in the Setup Menu option **FILE STORAGE > FOLDER OPTIONS**. Folder choices include **TOP-LEVEL**, **MID-LEVEL**, and **BOTTOM LEVEL FOLDERS**. Folders are created when the record key is pressed. This reduces the likelihood of empty folders.

Each folder resides in the folder one level below it. If the folder one level below the target folder is set to **<None>**, the target folder will reside in the next level folder that is set to something other than **<None>**.

Each folder level has a corresponding list of available names that can be edited manually by the user. To add an entry to the list of folder names of any folder level:

1. Access Setup Menu option **FILE STORAGE > FOLDER OPTIONS**
2. Select desired folder level and press the Headphone Encoder.
3. Rotate the headphone Encoder to select **<Add New Entry>** then press the Headphone Encoder. Use the on-screen keyboard to compose a name for the folder.
4. Slide the RTN / FAV Switch right to create the folder name and select it for this folder level.

Top-Level (Project) folder. The Top-Level folder can be named manually or set to **<None>**. The name of the Top-Level folder will also be stored in the PROJECT field of the iXML and bEXT chunks of all subsequently recorded WAV files.

Mid-Level (Tape/Roll/Daily) folder. The Mid-Level folder can be named manually, by the date, or set to **<None>**. When set to **<Daily>**, a folder will be automatically created and named according to the date. Whenever a new day occurs, the 633 will prompt asking if the user would like to create a

new daily folder. With an example date of August 20th, 2012, the naming format of the daily folder would be: 12Y08M20. The name of the Mid-Level folder will also be stored in the TAPE field of the iXML and bEXT chunks of all subsequently recorded WAV files.

Bottom-Level folder. The Bottom-Level folder can be named manually, by scene name, or set to **<None>**. When set to **<Scene>**, a new folder will be created each time the scene name is changed.

Automatic File splitting

During recording, the 633 will split a take that exceeds 4 GB into multiple files. The split is sample-accurate, so files joined together in post-production will be seamless. The maximum file size that the 633 creates can be adjusted from the Setup Menu option **FILE STORAGE > File Max Size**. The following file size options are available:

- 4GB
- 2GB
- 1GB
- 640MB
- 512MB

When recording MP3 files, splits will not be seamless.

Metadata Fields

633 Broadcast Wave Files include iXML (revision 1.5) data and bEXT chunk data. For bEXT and iXML-aware software applications this data is available. For applications that don't recognize bEXT or iXML, this information is ignored. The following chart details the supported metadata parameters.

- iXML: Metadata stored in the Broadcast Wave iXML chunk
- bEXT: Metadata stored in the Broadcast Wave bEXT chunk
- FMT: Metadata stored in the Broadcast Wave Format chunk

✓ = supported

Metadata	Type	Notes	Read	Write
		U = Entered by User M = Automatically Entered by the Machine		
General Information				
Project	iXML	U; via Folder Options menu Top-Level	✓	✓
Roll (Tape)	iXML, bEXT	M; uses creation date or is overridden by User U; via Folder Options menu Mid-Level	✓	✓
Scene	iXML, bEXT	U; via Scene Name menu	✓	✓
Take	iXML, bEXT	M or U; via Take Name menu	✓	✓
Notes	iXML, bEXT	U; via HDD menu	✓	✓
Circle Take	iXML	U; via Take List menu	✓	✓
File UID	iXML	M; Unique File Identifier		✓
File Sample Rate	iXML, FMT	U; via the Sample Rate menu	✓	✓
Digitizer Sample Rate	iXML	U; Actual sample rate of AD converter		✓
Bit Depth	iXML, FMT	U; via Bit Depth menu	✓	✓
Channels	iXML, FMT	U; Number of channels (tracks) in the file	✓	✓
Time Code Information				
Frame Rate	iXML, bEXT	U; via Frame Rate menu	✓	✓
TC Flag (ND or NDF)	iXML, bEXT	U; via Frame Rate menu		✓
Start Time Code	iXML, bEXT	M; Stored as a sample count since midnight	✓	✓

Duration		M	✓	✓
U-Bits	iXML, bEXT	U	✓	✓
Time Code Sample Rate	iXML	M		✓
Track Information				
Channel Index	iXML	M; Track Number		✓
Interleave Index	iXML	M		✓
Track Name	iXML, bEXT	U; via Track Names menu or HDD menu	✓	✓
Speed Information				
Master Speed	iXML	M		✓
Current Speed	iXML	M		✓
Speed Note	iXML	M		✓
Originator Information				
Originator	bEXT	M		✓
Creation Date	bEXT	M	✓	✓
Creation Time	bEXT	M	✓	✓
Originator Reference	bEXT	M		✓
Software Version	bEXT	M		✓
File Set Information				
Family UID	iXML	M; shared by files belonging to the same take		✓
Total Files	iXML	M; number of files representing a take		✓
File Set Index	iXML	M		✓
File History				
Original File Name	iXML	M		✓

Metadata in MP3 Files

Metadata is included in MP3 files inside the ID3 tags. Metadata in MP3 files can not be edited with the 633. The following table shows the ID3 fields that metadata is stored in and the format in which it is stored (Square brackets denote variables and are not included in actual metadata).

Metadata	ID3 Field	Format
Timecode value	Artist Name	TC=[HH:MM:SS:FF]
Scene name and Take number	Track Title	SC=[scene name] TK=[take number]
Frame rate and Duration	Album Title	FR=[frame rate] D=[duration]

Sound Reports

The 633 can generate sound reports as a comma separated values (CSV) file. CSV files can be opened and edited by any common spreadsheet application such as Microsoft Excel, OpenOffice Calc, Apple Numbers, Google Docs, and many more.

MP3 files are not included in Sound reports.

Sound Report Setup

A sound report consists of two sections: A Take List section which provides information for each take in the folder the sound report was generated in, and an Overview section that contains ancillary information to the Take List section. The Overview section is first, followed by the Take List section.

Overview Section

The following table lists the rows that make up the Overview section.

Row	Description	Default
Project:	The name of the project.	<NONE>
Producer:	The name of the producer.	<NONE>
Director:	The name of the director.	<NONE>
Job:	The title of the job.	<NONE>
Date:	The date. The <System Date> option will insert the current system date (In MM/DD/YY format) at the time the report is generated.	<System Date>
Location:	The location.	<NONE>
Sound Mixer:	Your name.	<NONE>
Phone:	Your phone number. Limited to numbers and symbols.	<NONE>
Email:	Your email address.	<NONE>
Client:	Client's name.	<NONE>
Boom Op:	Boom operator's name.	<NONE>
Prod.Co:	The name of the production company.	<NONE>
Prod.Co. Tel:	Production company telephone number. Limited to numbers and symbols.	<NONE>
Mics:	Notes about mics used.	<NONE>
Comments:	Miscellaneous comments.	<NONE>
Roll:	The roll / daily identifier.	<NONE>
Media:	Media type	<NONE>
File Type:	File type. Options are <Current Selection> (WAV Poly or MP3) or <None>	<Current Selection>
File Type:	File type. Options are <Current Selection> (WAV Poly or MP3) or <None>	<Current Selection>
Sample Rate:	Sample rate of recorded audio. Options are <Current Selection> (At time of report generation) or <None>	<Current Selection>
Frame Rate:	Timecode frame rate. Options are <Current Selection> (At time of report generation) or <None>	<Current Selection>
Bit Depth:	Bit depth of recorded audio. Options are <Current Selection> (At time of report generation) or <None>	<Current Selection>
Tone Level:	The amplitude of the 633's tone generator. Options are <Current Selection> (At time of report generation) or <None>	<Current Selection>

Information in the Overview section is managed in the Setup Menu option **FILE STORAGE > Sound Report Info**. The 633 derives information for the overview section from these settings at the time the sound report is generated.

Take List Section

The following fields make up the Take List section. Each row of this section corresponds to a take, and each field corresponds directly to the metadata of that take (bEXT and iXML).

- File Name
- Scene
- Take
- Length
- Start TC
- Trk 1 to Trk 16 (16 fields)
- Notes

Generating Sound Reports

A sound report can be generated for all the files in any folder on the 633. Sound reports are created from the File List.

To generate a sound report:

1. Press and hold the Menu Button and then press the Headphone Encoder to access the Take List.
2. Slide the Slate/Tone Switch to access the File List.
3. To create a sound report for the files at the root level of the CF or SD card, highlight the desired card and skip to the next step. To create a sound report for one folder only, use the Headphone Encoder to navigate to the folder and highlight it (do not go into the folder).
4. Slide the RTN / FAV Switch to access folder options for the highlighted folder.
5. Select the Create Sound Report option. A CSV file will be created in the selected folder. Sound reports created for at the root level of the CF or SD card will be saved as *REPORT.CSV* in the root of that media. Sound Reports created in a subfolder will be named with the last six characters of that folder followed by “*_REPORT.CSV*”.

Take Management

Take List

The Take List consists of recorded takes on all media. Takes are listed in the left column in the order they were recorded, with the most recent take at the top. The right column displays details about the highlighted take, including:

- TC: Start timecode value of the take.
- Card: What media the take resides on.
- Folder: The folder that the take resides in.
- Scene: The scene name of the take.
- Take: The take number of the take.
- Date: The date that the take was recorded.
- Notes: The notes metadata field.

To access the Take List press and hold the Menu Button, then press the Headphone Encoder. The Take List can also be accessed from the Setup Menu option **FILE STORAGE > Take List**. The top take in the Take List is displayed with orange text. This is a special entry that represents the next take to be recorded. Editing the metadata of this entry will affect all subsequent recordings.

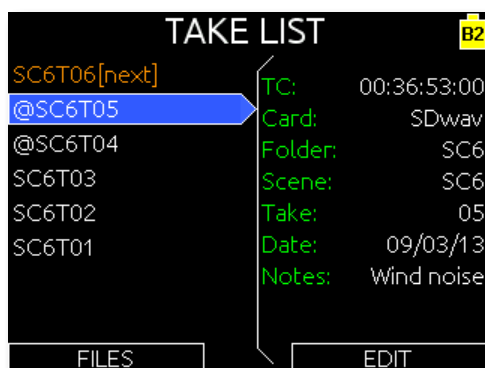

Take Number

A take is a single recording that is represented by a single poly or mp3 file or a group of monophonic files on each media. Takes are labeled numerically and begin at the number 1. Each new recording creates a new take. The take number will increment by one until it is reset. Take numbers will be two digits to 99 (01-99) and digits will be added accordingly from 100 and up. By default, take numbers will reset when a new Scene is selected or when a new Daily folder is created. This behavior can be changed with the Setup Menu option **FILE STORAGE > Take Reset Mode**. The take number is written in the file name (preceded by the letter "T") and stored in the metadata of each recorded file. (See *"File Structure"*, page 39)

To manually set the take number:

1. Enter the Take List (Menu Button + Headphone Encoder press or **FILE STORAGE > Take List**)
2. Highlight the next take (indicated by orange text and the phrase "[next]") and slide the RTN / FAV Switch.
3. Rotate the Headphone Encoder to select Take.
4. Using the Headphone Encoder in the numeric entry dialog, enter a new take number. The next take will use this take numbers and subsequent takes will increment from this number until the take number is reset.

To change set the take number of an already recorded take:

1. Enter the Take List (Menu Button + Headphone Encoder press or **FILE STORAGE > Take List**)
2. Highlight the take to be edited and slide the RTN / FAV Switch.
3. Rotate the Headphone Encoder to select Take. The take number will be changed in the metadata of all files for this take, and all files for this take will be renamed to reflect the new take number.

False Take

To mark the last recorded take as a false take and decrement the Take number, press and hold the Headphone Encoder, then slide the Transport Control left (Rewind). A dialog will appear to confirm the false take action. When a take is confirmed as a false take, it will be moved to the FALSETAKES folder on each media and the take number will be decremented by 1. Files will remain in the FALSE-TAKES folder until they are deleted or the card is formatted.

Scene Name

A scene is a logical group of takes. Its name can be any combination of letters or numbers up to 9 characters in length. The scene name will only change when a new scene name is entered by the user or when the scene is incremented. The scene name is written in the file name and stored in the metadata of each recorded file. (See *"File Structure"*, page 39)

To enter and select a new scene name:

1. Enter the Take List (Menu Button + Headphone Encoder press or **FILE STORAGE > Take List**)
2. Highlight the next take (indicated by orange text and the phrase "[next]") and slide the RTN / FAV Switch to access the Scene Name List.
3. Rotate the Headphone Encoder to select scene name from the Scene Name List.
4. Using the Headphone Encoder, select an existing scene name and press the Headphone Encoder to select this scene name. To enter a new scene name, select **<Add New Entry>** and enter a new scene name.

To edit the scene name of an already recorded take:

1. Enter the Take List (Menu Button + Headphone Encoder press or **FILE STORAGE > Take List**)
2. Highlight the take to be edited and slide the RTN / FAV Switch to access the Scene Name List.

3. Rotate the Headphone Encoder to select scene name from the Scene Name List.
4. Enter a new scene name. The scene name will be changed in the metadata of all files for this take, and all files for this take will be renamed to reflect the new scene name.

A scene name can be removed from the Scene Name List by sliding the Slate/Tone Switch right when the scene name is highlighted in the Scene Name List.

To quickly edit the scene name, press and hold the Headphone Encoder then slide the RTN / FAV Switch left. This will display the on screen keyboard where the scene name can be edited directly. When accessed during record, the scene name of the currently recording take will be edited. When accessed at any other time, the scene name of the next take will be edited.

Scene Increment

By default Scene names will not increment. When Setup Menu option **FILE STORAGE > Scene Increment Mode** is set to either **Character** or **Numeric**, scene names can be incremented manually by pressing and holding the Headphone Encoder, then sliding the Transport Control right (Fast Forward). If the current scene name does not end in a number or letter, a "1" or "A" will be added (for Numeric or Character increment mode, respectively). If a scene name does end in a letter or number, the letter or number will be incremented.

Take Notes and Phrases

The Notes metadata field is used to provide extra information about a take that is not accounted for with the other metadata fields.

Phrases

Often, a particular phrase will be used in the notes field of many different takes. To save data entry time, the 633 provides the ability to save phrases that can be entered into the notes field quickly. To edit, create, and use phrases:

1. Enter the Take List (Menu Button + Headphone Encoder press or **FILE STORAGE > Take List**).
2. Highlight the take to be edited, and slide the RTN / FAV Switch left or right.
3. Select the Notes field and press the Headphone Encoder.
4. Select **<Use Phrase>** and press the Headphone Encoder to enter the Phrase List.
5. To use a phrase, select it in the list and press the Headphone Encoder. To create a new phrase, slide the RTN / FAV Switch right. To edit a phrase, select it in the list and slide the Slate/Tone Switch right. To delete a phrase, select it in the list and slide the Slate/Tone Switch left.

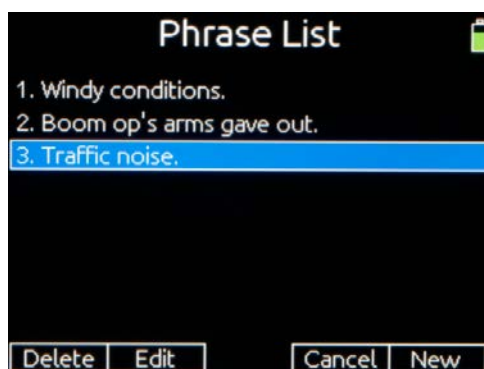

The Phrase List can also be accessed by holding the Headphone encoder and then sliding the RTN / FAV Switch right. When using this shortcut during recording, the phrase selected will be applied to the currently recording take. When using this shortcut during standby, the phrase will be applied to the last take recorded. This shortcut is not available during playback.

Timecode

The 633 holds accurate timecode for up to two hours between battery changes using its internal, Li-Ion timecode battery. After two hours without power, the 633 reverts to a slightly less-precise time-of-day crystal to maintain the date/time of the unit. This timecode battery is charged whenever the 633 is powered up.

If the time-of-day clock is reset during the production day or if the timecode mode is changed from 24-hour run to another mode and back, the timecode value will change. You must re-jam all timecode devices to ensure proper synchronization.

File-based recorders place a timecode and frame rate stamp in the bEXT and iXML chunks of an AES31 (Broadcast WAV) file. During playback, the 633 generates SMPTE timecode from this number and extrapolates it based on the timecode frame rate.

All files generated by the 633 have timecode numbers that begin on the 0 frame (or 02 in DF modes) and end on the 0 frame such that a file's duration is always an integer number of seconds long. If necessary, pre-roll and post-roll is dynamically applied to accomplish this. This simplifies synchronization in post-production.

Sound Devices Wave Agent Beta for Mac OS and Windows computers allows users to add or edit Beginning Timecode Stamps. (See "Wave Agent", page 71)

The timecode value is always displayed on all Meter Views. By default, the timecode frame rate is displayed on the L, R, X1-X4, RTN Meter View only and the recorder sample rate is displayed in that position on all other Meter Views. The following image shows the L, R, X1-X4, RTNL, RTNR Meter View with default settings.

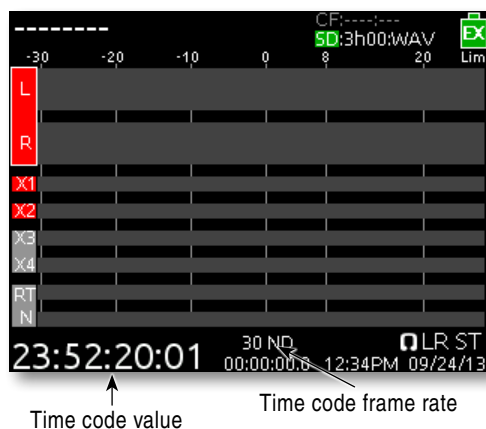

To toggle this display mode (so that the recorder sample rate is displayed on the L, R, X1-X4, RTNL, RTNR Meter View only and the timecode frame rate is displayed on all other Meter Views), press and hold the Meters Button, then slide the RTN / FAV Switch left.

The display position and size of the timecode and absolute time can be switched on all Meter Views from Setup Menu option **TIMECODE > Display Mode**.

Timecode Modes

The timecode mode determines if the 633 generates or reads timecode and when timecode runs and stops. Timecode mode is changed from the Setup Menu option **TIMECODE > Timecode Mode**.

Record Run

Rec Run - Generator mode. The 633 sends running timecode while recording and stationary timecode while not recording. Timecode in this mode defaults to the last stationary value at power-up. When switching to Record Run from another mode, the internal generator will stop at the last number generated. A user-defined value can be jammed into the internal generator from the Setup Menu option **TIMECODE > Set Generator TC**.

Free Run

Generator mode. Time code runs continuously. The value can be set by “jamming value” in the Setup Menu option **TIMECODE/SYNC > Jam Menu** or by manually setting a value from the Setup Menu option **TIMECODE/SYNC > Set Generator TC**.

Free Run Auto Mute

Functions the same as Free Run mode except timecode signal is muted from the LEMO output when the 633 is in stopped mode. This allows rec-run functionality when Rec Run mode is not suitable (e.g. Multi-camera shoots).

24h Run (24 hour Run)

Generator mode. Time code runs continuously. When this Time Code Mode is selected or when the time/date is altered, the time code value is jammed to the value of the time-of-day clock. The value can be set by “jamming value” in the Setup Menu option **TIMECODE/SYNC > Jam Menu** or by manually setting a value from the Setup Menu option **TIMECODE/SYNC > Set Generator TC**.

24h Run Auto Mute

Functions the same as 24h Run mode except timecode signal is muted from the LEMO output when the 633 is in stopped mode. This allows rec-run functionality when Rec Run mode is not suitable (e.g. Multi-camera shoots).

External Timecode

Ext-TC - Reader mode. The internal timecode generator follows an external timecode signal appearing at the timecode input. If the external timecode is removed the internal generator stops as well. Recording is triggered manually with the Transport Control.

External Timecode Auto-Record

Ext-TC Auto-Rec - Reader mode. The internal timecode generator follows an external timecode signal appearing at the timecode input. If the external timecode is removed the internal generator stops as well. The 633 automatically begins recording when running timecode is sensed. When stopped timecode is sensed, recording stops. (See “Meter Ballistics”, page 20)

External Timecode Continuous

Ext-TC/Cont - Reader mode. The internal timecode generator follows an external timecode signal appearing at the timecode input. If the external timecode is removed the internal generator continues to run to preserve continuous timecode. Recording is triggered manually with the Transport Control.

External Timecode Auto-Record Continuous

Ext-TC Auto-Rec/Cont - Reader mode. The internal timecode generator follows an external timecode signal appearing at the timecode input. If the external timecode is removed the internal generator continues to run to preserve continuous timecode. The 633 automatically begins recording when run-

ning timecode is sensed. When stopped timecode is sensed, recording stops. (See “Meter Ballistics”, page 20)

Timecode Frame Rate

The frame rate of the timecode generator is set with the Setup Menu option **TIMECODE > Frame Rate**. When using an external timecode mode, ensure that the 633’s frame rate is equal to (or cross-jam compatible) the external frame rate. When the incoming timecode frame rate differs from the 633’s frame rate, the frame rate indicator on the L, R, X,1, X2, X3, X4, RTN Meter View will flash the incoming frame rate in red and 633’s frame rate in white.

Jam Menu

The Setup Menu option **TIMECODE > Jam Menu** displays the timecode Jam Menu. This special screen displays detailed information about the 633’s internal SMPTE timecode generator and SMPTE timecode present on the 633’s timecode input.

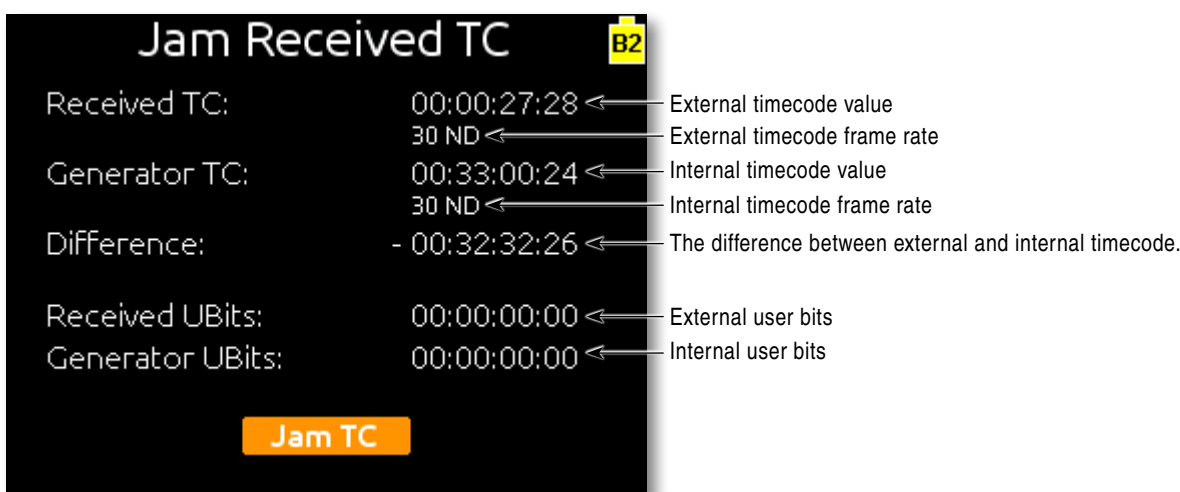

To jam the 633’s internal timecode (and User Bits) to external timecode, press the Headphone Controller while the Jam Menu is displayed. To leave the Jam Menu without jamming to external timecode, press the Menu Button, Meters Button, or Stop Button.

The Difference field is useful for checking timecode drift between the 633 and external timecode devices.

User Bits

To set User Bits, use Setup Menu option **TIMECODE/SYNC > Set Generator UBits**. Using the headphone encoder, set any **UU** fields to the desired value. Bits are not saved until **Done** is pressed. User bits can be set manually or generated dynamically from date values by setting the **User Bits Mode**. When User Bits Mode is set to uu:uu:uu:uu, values can be set manually. Other modes will populate the user bits value with year (“yy”), month (“mm”), and day (“dd”) values.

“UU” values are retained with the PowerSafe battery and will be reset 2 hours after shutdown.



Timecode Hold Off

Some devices that send rec-run timecode will sometimes have a tendency to send short bursts of running timecode or incorrect values. When using timecode to trigger recording on the 633 (External timecode auto-record modes) this behavior can result in unintentional recordings or incorrect timecode stamps on the 633. To eliminate these problems, the 633 features a Timecode Hold Off function.

When using external timecode auto-record modes, the 633 will wait (“hold off”) for the amount of time specified in Setup Menu option **TIMECODE > Hold Off** before beginning recording. Running timecode lasting less than the Timecode Hold Off value will not trigger a recording on the 633.

Things to consider when using Timecode Hold Off:

- This feature only applies in **Ext-TC Auto-Rec** and **Ext-TC Auto-Rec/Cont**.
- If Pre-Roll is set, it will be applied (See “Pre-Roll”, page 36). Pre-Roll will only capture audio from the initial detection of a timecode signal. If no Pre-Roll is selected, the file will begin after the Hold Off time expires. It is best practice to set Pre-Roll, in the Setup Menu option **RECORDER > Pre-Roll Time**, to a value greater than the selected Timecode Hold Off value. This ensures that audio is captured from the moment a timecode signal is detected and that unintentional files triggered by short bursts of timecode are not generated.

Time and Date Settings

Properly setting the time and date is important for file metadata, file system functioning, and some timecode functions. To set the time and date, access Setup Menu option **SYSTEM > Set Time/Date**. Rotate the Headphone Encoder to move the orange highlighter to the desired field. With the desired field highlighted, press the Headphone Encoder to edit the field, rotate the Headphone Encoder to change the value, and press the Headphone Encoder again to set the value.

Time Zone and Daylight Savings

Setting the correct GMT time zone and daylight savings values is important for correct data stamping on the exFAT file system. These settings are configured with Setup Menu options **SYSTEM > Daylight Savings Time** and **SYSTEM > Time Zone**. The following map displays the GMT time zones.

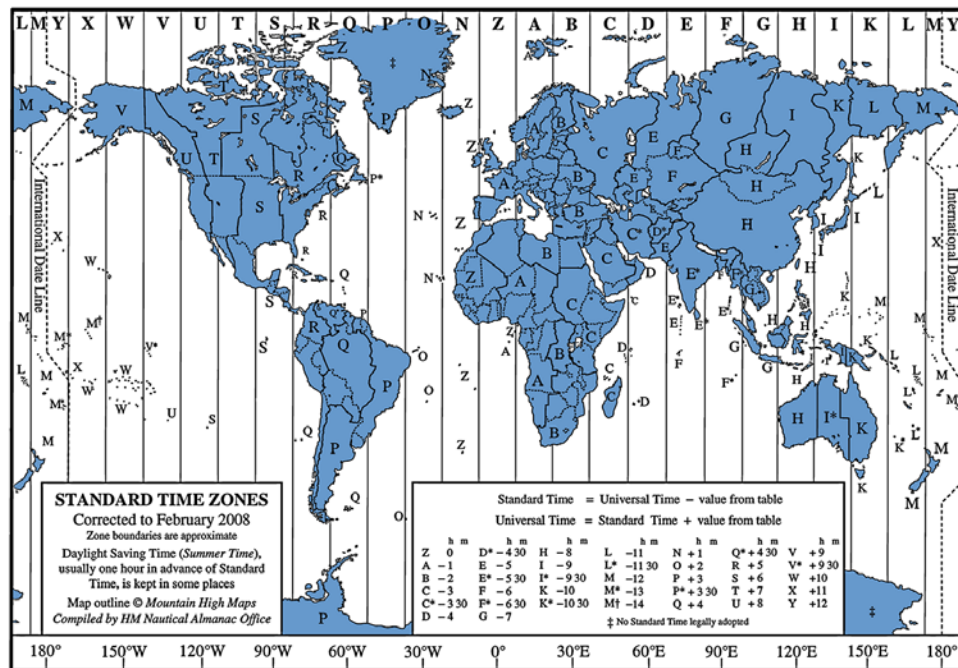

Time and Date Format

The format of the date (as displayed in BWF metadata and as used in the naming of the Daily folder) can be in a month/day/year, day/month/year, or year/month/day format. Change this setting from the Setup Menu option **SYSTEM > Date Format**.

The format of the time (as displayed in BWF metadata and on the Main Screen) can be set to 12 or 24 hour mode from Setup Menu option **SYSTEM > Time Format**.

Powering

The 633 features a Quad Powering configuration with PowerSafe technology. Any of three power sources can be attached simultaneously: External DC power, 2 Rear-mounted L-Series batteries, and internal AA batteries (NiMH or Lithium chemistries preferred) (See “AA Battery Powering”, page 52). When multiple power sources are connected, the 633 will use only one source at a time. The order of precedence for power sources is:

1. External DC power. (EX)
2. B1 L-Series battery. (B1)
3. B2 L-Series battery. (B2)
4. Internal AA batteries. (IN)
5. PowerSafe circuitry (Shutdown)

When the active power source is removed (or its voltage depleted), the 633 will display a notice on the LCD indicating which source it is switching to.

To force a complete shutdown of the 633: Slide the Power switch to the Off position then press and hold the Menu button for 5 seconds. The LCD will briefly flash to indicate that the unit is completely powered down. This will turn off the timecode backup battery, requiring timecode to be rejammed and user bits to be reset upon next power up.

External DC Powering

The 633 can be powered from any DC voltage from 10 to 18 VDC. Pin-4 of the locking, Hirose connector is positive (+) and pin-1 is negative (-).

By default, the 633 will switch from external DC powering to the next available power source when the voltage at the external DC connection drops below the voltage set in Setup Menu option **POWER > Ext DC Ref**. Setting the external DC reference to a value appropriate for the type of battery being used for external powering will maximize runtime with that battery.

The 633 can be configured to power down (instead of switching power sources) when the external voltage drops below the external DC reference by setting Setup Menu option **POWER > Ext DC Loss** to **Shutdown**. This option allows the 633 to be powered up and down by switching the external DC power source on and off.

L-Mount Battery Powering

Up to two L-Series batteries can be attached to the rear of the 633. Several power capacities are available in this battery type, ranging from 1000 mAh to 7000 mAh. Larger amp-hour batteries provide more run-time. The L-Series battery mounts are referred to as B1 and B2. The B1 mount is nearest to the input panel and the B2 mount is nearest to the output panel.





The 633 uses only one L-Series battery at a time. When both batteries are mounted, B1 will be used first. When the B1 battery is depleted or removed, the 633 will switch to B2 (if present).

AA Battery Powering

The 633 uses six AA-sized (LR6) batteries. The 633 can use NiMH, 1.5V Lithium, or Alkaline AA batteries. Run time will be very limited when using Alkaline batteries (30 minutes to 1 hour, depending on settings). NiMH or Lithium batteries are the preferred type because of the approximate 2x to 4x run time compared to Alkaline batteries.

Voltage Metering

The Main Screen displays a DC Voltage Indicator in the form of a battery icon that indicates the power source currently in use and its level. When the battery icon is filled green, the voltage of the active power source (internal or external) is full. The background color will change from green, to yellow, to orange, and to red as voltage depletes.

	Good
	OK
	Warning
	Critical. No other backup power sources available. Automatic shutdown will occur soon.

The DC Voltage Indicator will only flash red when there are no other connected backup power sources remaining with adequate voltage. When the DC Voltage Indicator is flashing red, automatic shutdown will occur soon. During automatic shutdown, the 633 will display a warning, stop any active recordings, finish writing files, and shut the 633 down. The PowerSafe Battery will power the 633 during this time.

Power Screen

Specific, numeric voltage levels of all connected power sources can be monitored from the Power Screen. The Power Screen is accessed from the Setup Menu: **POWER**.

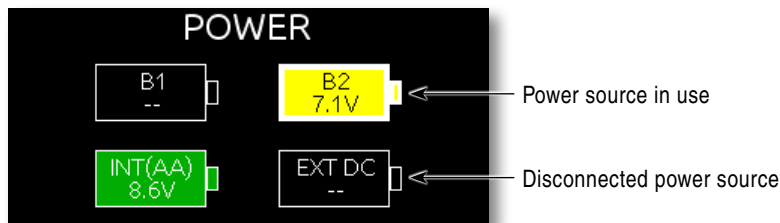

Each power source and its voltage level is displayed on the Power Screen. Disconnected power sources have a black background and no voltage level. The power source currently in use has a thick, white border.

Voltage Range

The voltage range of the DC Voltage Indicator and the Warning Voltage Threshold can be adjusted for external DC power sources. These values are adjusted with the Setup Menu option **POWER > Ext DC Ref**. Adjust the DC Reference to match the type of battery being used to power the 633 externally. The voltage range and Warning Voltage Threshold for each setting are shown in the following chart.

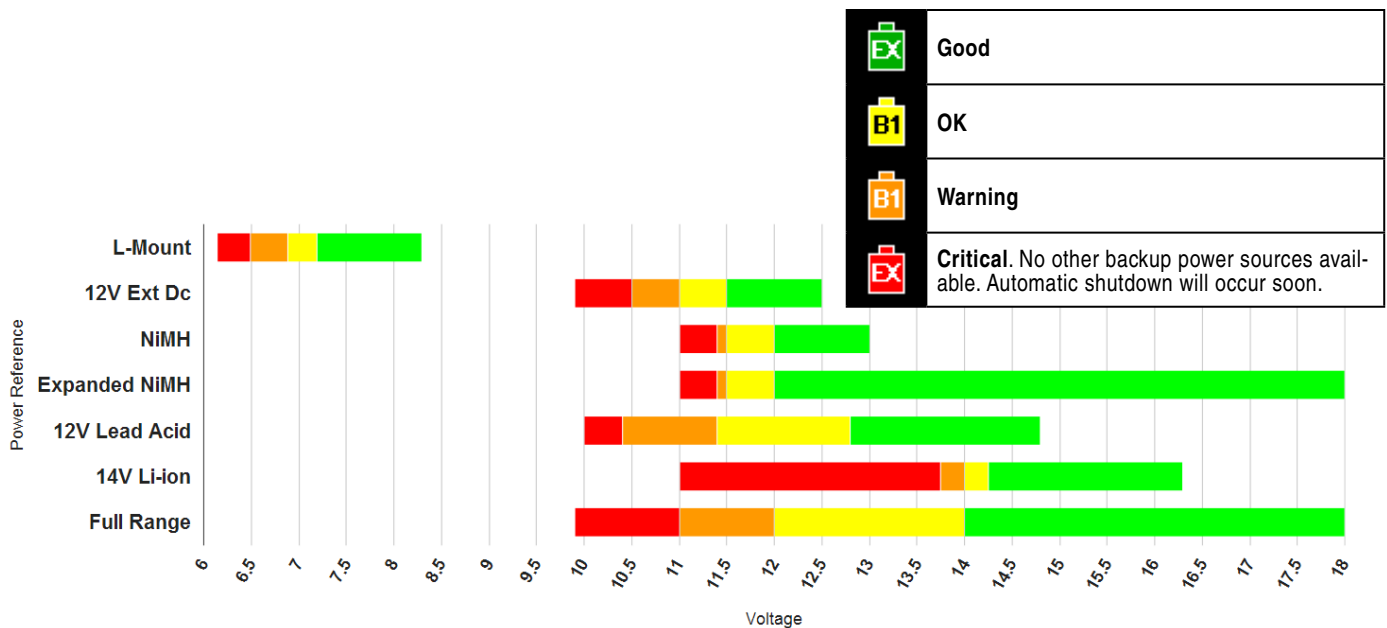

PowerSafe

When all connected power sources are depleted or power is lost unexpectedly, the PowerSafe circuitry will activate: The 633 will display a warning, stop any active recordings, finish writing files, and shut the 633 down. The PowerSafe Battery will power the 633 during this time. This feature ensures that files will be protected even in the event of unexpected power loss.

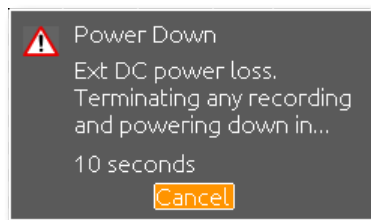

The PowerSafe Battery recharges with the active power source only when the 633 is powered on.

QuickBoot

QuickBoot circuitry is enabled for 2 hours after the 633 is powered down. During this time, the 633 can turn on and start recording in less than 2 seconds. Each time the 633 is turned on and off, this 2 hour timer is reset. After 2 hours of being powered down, QuickBoot is deactivated and powering up will result in a normal, slightly longer boot process.

The TC LED on the front panel will blink every 2 seconds to indicate QuickBoot is engaged. To manually deactivate QuickBoot, hold the Menu Button down for 5 seconds while the 633 is powered down. The LCD screen will flash quickly and the TC LED will stop blinking, indicating that QuickBoot is not activated.

If QuickBoot is not engaged when the 633 is powered down, or if QuickBoot deactivates less than 2 hours after powering down, the PowerSafe Battery might be depleted. To charge the PowerSafe Battery, power the 633 on for at least one hour.

Power Consumption

The 633 is very power efficient. The amount of current it draws depends on which features are enabled. The following list highlights the larger current drawing functions.

1. Microphone powering - the main source of extra 633 current draw (See “Phantom Power”, page 16). 48 V Phantom can draw copious amounts of current depending on what model microphone is used. Two identical phantom powered microphones draw twice as much current as one. Microphones vary widely in their current draw depending on type and phantom voltage applied.
2. Audio Recorder - the recorder, whether in record or playback, increases power consumption.
3. Digital Outputs - disable digital outputs in the Setup Menu when they are not needed since they draw additional current.
4. Output drive level - higher output drive levels into multiple, low-impedance inputs increases power consumption
5. Headphone Output circuit - high headphone output levels increase current draw.
6. LED and LCD Brightness - decrease LED and LCD brightness to extend battery runtime.

Using a USB Keyboard

To aid in navigation and data entry, a standard USB keyboard can be connected to the 633. To use a USB keyboard, connect the male USB A plug of the keyboard into the supplied USB A female adapter, then connect the keyboard to the left panel USB B jack on the 633 with the supplied USB cable. Change the Setup Menu option **SYSTEM > USB Port** to **Keyboard**.

Keyboards with an embedded USB hub are not compatible. Some keyboards must be disconnected when powering the 633 up and only connected after the 633 has booted.

Whenever the on-screen keyboard is displayed, an attached USB keyboard can be used to enter data. The table below shows the keyboard shortcuts available.

Key Combination	Action
F1	Accesses the Setup Menu.
F2	Accesses the Take List.
F3	Switches between Meter Views.
Menu Button	Accesses the Setup Menu.
Ctrl + R	Record
Ctrl + S	Stop
Spacebar	Play
Left Arrow	Main Screen: Rewind. Input Settings Screen: Toggle phase inversion.
Right Arrow	Main Screen: Fast Forward. Input Settings Screen: Toggle LR Mix assignment.
Up / Down Arrows	Main Screen: Adjusts headphone volume. In menus: Moves highlighter. While editing parameters: Changes value.
Enter	Main Screen: Accesses HP Headphone Source List. In menus: Same as encoder press (activates current selection).
Alt + Enter	Main Screen: Toggles arming of selected track.
Ctrl + Enter	Accesses gain adjustment for highlighted L, R, X1, X2, or RTN track.
Ctrl + Up / Down Arrows	Main Screen: Select tracks. Input Settings Screen:
Ctrl + Left Arrow	Input Settings Screen: Change X1 assignment.
Ctrl + Right Arrow	Input Settings Screen: Change X2 assignment.

Storing and Recalling Settings

The 633 can store and recall user settings to User Setup Files on the SD card, CF card, or internal memory. User Setup Files contain all settings made in the Setup Menu and all Input Settings (including routing). Multiple, custom-named setup files can be saved to the CF or SD card. Additionally, four setups can be saved to the 633's internal memory where they will be available even when no CF or SD card is inserted.

To save a User Setup File, access the Setup Menu option **Quick Setup**. Select the Save option for the desired storage area and enter a name for the Setup File.

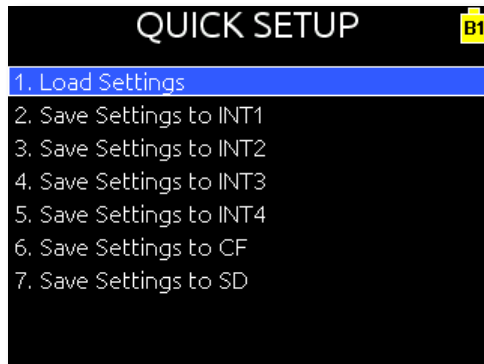

- The **INT1**, **INT2**, **INT3**, or **INT4** areas will hold one setup each. Settings stored to these areas will overwrite any settings previously stored there.
- Saving a Setup File to the CF or SD card will create a folder named **SETTINGS** (If it is not already present) and place the Setup File in that directory. If a Setup File with the entered name already exists, the previous Setup File will be overwritten.

Setup Files stored on the CF or SD card can be deleted from the File List. To delete a Setup File from the CF or SD card:

1. Press the Menu Button to enter the Setup Menu.
2. Use the Headphone Encoder to select option **FILE STORAGE > File List**.
3. Use the Headphone Encoder to select either CF or SD.
4. Use the Headphone Encoder to select the **SETTINGS** folder.
5. Use the Headphone Encoder to highlight the Setup File to be deleted.
6. Slide the RTN / FAV Switch to access File Options for the Setup File.
7. Use the Headphone Encoder to select **Delete**.

Setup Menu

Power

The **Power** Setup Menu option displays the Power Screen as well as the following options.

#	Parameter Name	Description	Options
1	Ext DC Ref	Adjust the voltage range and Warning Voltage for the external DC Voltage Indicator.	» 12V Ext DC <ul style="list-style-type: none"> • NiMH • Expanded NiMH • 12V Lead Acid • 14V Li-ion • Full Range
2	Ext DC Loss	What action to take when external power is removed or external voltage drops below the set threshold.	» Switch Power Source <ul style="list-style-type: none"> • Shutdown

Inputs

#	Parameter Name	Description	Options
1	Ch 1-2 Linking	Links channels 1 and 2 with or without Mid/Side decoding.	» Unlinked <ul style="list-style-type: none"> • 1-2 • 1-2M/S
2	Ch 5-6 Linking	Links channels 5 and 6 with or without Mid/Side decoding.	» Unlinked <ul style="list-style-type: none"> • 5-6 • 5-6M/S
3	Phantom Voltage	Globally adjust voltage level of phantom power (on all inputs which have phantom power enabled).	» 48V <ul style="list-style-type: none"> • 12V
4	PFL Toggle Mode	Change the behavior of Input Select Switches. (<i>See “PFL Toggle Mode”, page 25</i>)	» 6ch <ul style="list-style-type: none"> • 3ch
5	Input to ISO Routing	Displays a sub-menu where inputs 1 through 6 can be set to route to their respective ISO track pre- or post-fader, independently.	» Prefade <ul style="list-style-type: none"> • Postfade
6	Input Delays	Displays a sub-menu where inputs 1 through 6 can be delayed, independently.	<ul style="list-style-type: none"> • 0.0 to 30.0 ms (0.1 ms increment) » 0.0 ms

Outputs

#	Parameter Name	Description	Options
1	Linking	For the purposes of arming and level adjustment, link tracks L and R, and/or X1 and X2.	<ul style="list-style-type: none"> • LR, X1X2 » LR, X1, X2 • L, R, X1X2 • L, R, X1, X2
2	XLR-L Out	Select the analog output level or engage AES3 digital on the L XLR-3M output.	<ul style="list-style-type: none"> • Mic » Line • -10 • AES 1,2
3	XLR-R Out	Select the analog output level or engage AES3 digital on the R XLR-3M output.	<ul style="list-style-type: none"> • Mic » Line • -10 • AES 3,4

#	Parameter Name	Description	Options
4	TA3-X1 Out	Select the analog output level of the Aux 1 TA3 output.	<ul style="list-style-type: none"> • Mic » Line • -10
5	TA3-X2 Out	Select the analog output level of the Aux 2 TA3 output.	<ul style="list-style-type: none"> • Mic » Line • -10
6	AES Output Routing	Displays the AES Routing Screen where sources can be assigned to AES output channels.	
7	Playback to Outputs	Select destination for playback signal.	<ul style="list-style-type: none"> » All Outputs • Headphones Only
8	X1, X2 Routing	Displays the X1,X2 routing Screen where sources can be assigned to the X1 and X2 output channels.	
9	X3, X4 Routing	Displays the X3,X4 routing Screen where sources can be assigned to the X3 and X4 output channels.	
10	Output Delays	Displays a sub-menu where outputs L, R, X1, X2, X3, and X4 can be delayed, independently.	<ul style="list-style-type: none"> • 0.0 to 10.0 frames (0.1 frame increment) » 0.0 frames

Limiters

#	Parameter Name	Description	Options
1	Limiter Enable	Globally disable input and output limiters and select hard or soft knee. (<i>See "Limiters", page 19</i>)	<ul style="list-style-type: none"> • Off » Hard Knee • Soft Knee
2	Input 1-6 PostFade Threshold	Set the level at which input limiters will begin limiting.	<ul style="list-style-type: none"> • +4 to +18 dBu (1 dBu increment) » 16 dBu
3	L,R Linking	Links limiters for L and R tracks.	<ul style="list-style-type: none"> » Off • On
4	L,R Threshold	Limiter threshold for Master Bus	<ul style="list-style-type: none"> • +4 to +18 dBu (1 dBu increment) » 16 dBu
5	X1,X2 Linking	Links limiters for X1 and X2 tracks.	<ul style="list-style-type: none"> » Off • On
6	X1,X2 Threshold	Limiter threshold for Aux Bus	<ul style="list-style-type: none"> • +4 to +20 dBu (1 dB increment) » 16 dBu

Recorder

#	Parameter Name	Description	Options
1	Record to CF	Sets the type of file and which tracks to record to the CF card.	<ul style="list-style-type: none"> • Off » Wav Poly • Wav Poly (ISOs Only) • Wav Poly (LR Only) • Wav Poly (X1X2 only) • MP3 (LR) • MP3 (X1X2) • Wav Mono • Wav Mono (ISOs only)

#	Parameter Name	Description	Options
2	Record to SD	Sets the type of file and which tracks to record to the SD card.	<ul style="list-style-type: none"> • Off » Wav Poly • Wav Poly (ISOs Only) • Wav Poly (LR Only) • Wav Poly (X1X2 only) • MP3 (LR) • MP3 (X1X2) • Wav Mono • Wav Mono (ISOs only)
3	MP3 Bit Rate	The bitrate of recorded MP3 files.	<ul style="list-style-type: none"> » 320kbs • 192kbs • 128kbs
4	Sample Rate	The internal sample rate and sample rate of recorded WAV files.	<ul style="list-style-type: none"> • 44.1k • 47.952k • 47.952kF » 48k • 48.048k • 48.048kF • 88.2k • 96k • 192k
5	Bit Depth	The bit depth of recorded WAV files.	<ul style="list-style-type: none"> » 24 • 16
6	Pre-Roll Time	Adjust the amount of record time to be appended before each recording. Maximum value is 3 seconds when recording mono WAV files or using 88.2k sample rate. Maximum value is 1 second when using 192k sample rate..	<ul style="list-style-type: none"> • 0 to 6 seconds (1 second increment) » 0 s

Timecode

#	Parameter Name	Description	Options
1	Timecode Mode	Sets the running mode for the internal timecode generator and/or the method which the 633 receives SMPTE timecode..	<ul style="list-style-type: none"> • Off • Rec Run » Free Run • Free Run Auto Mute • 24h Run • 24h Run Auto Mute • Ext-TC • Ext-TC Auto-Rec • Ext-TC/Cont. • Ext-TC Auto-Rec/Cont.
2	Frame Rate	Sets the frame rate for the internal timecode generator.	<ul style="list-style-type: none"> • 23.976 • 24 • 25 • 29.97nd • 29.97df » 30nd • 30df
3	Hold Off	Sets the duration that a valid timecode signal has to be recognized by the 633 before generating a new take while in Ext TC-Auto Record and Ext TC/cont-Auto Record modes.	<ul style="list-style-type: none"> • 0.0-8.0 s (0.1 second increment) » 0.0 seconds

#	Parameter Name	Description	Options
4	Jam Menu	Displays the Timecode Jam Screen, where internal, external, and difference timecode can be displayed and the 633 timecode generator jammed to external timecode.	
5	Set Generator TC	Displays a dialog where the 633 internal timecode generator can be set to a given value. When highlighter is orange, turn Headphone Encoder to highlight a field and press Headphone Encoder to edit. When highlighter is blue, turn Headphone Encoder to change the value, and press Headphone Encoder to accept the value.	
6	Set Generator UBits	Sets the timecode user bits of the 633 timecode generator. User bits can be dynamically generated from date. (<i>See "User Bits", page 49</i>)	
7	Display Mode	Selects the source of the large numerical display on the Main Screen.	<ul style="list-style-type: none"> • Big A-Time » Big Timecode

File Storage

#	Parameter Name	Description	Options
1	Take List	Displays the Take List.	
2	File List	Displays the File List.	
3	Folder Options	Allows the user to organize files in root and sub-folders. For no folders, select <None> on every level.	<ul style="list-style-type: none"> • Top-Level • Mid-Level • Bottom-Level
4	Sound Report Info	Allows the user to enter default values for sound report fields. The default values are indicated in parenthesis.	<ul style="list-style-type: none"> • Project (<None>) • Producer (<None>) • Director (<None>) • Job (<None>) • Date (<System Date>) • Location (<None>) • Sound Mixer (<None>) • Phone (<None>) • E-Mail (<None>) • Client (<None>) • Boom Op (<None>) • Prod. Co. (<None>) • Prod. Co. Tel. (<None>) • Mics (<None>) • Comments (<None>) • Roll (<None>) • Media (<None>) • File Type (CF) (<Current Selection>) • File Type (SD) (<Current Selection>) • Sample Rate (<Current Selection>) • Frame Rate (<Current Selection>) • Bit Depth (<Current Selection>) • Tone Level (<Current Selection>)
5	File Max Size	Selects the file size when the 633 will close, then start a new file. The 633 will not record a file larger than the selected size.	<ul style="list-style-type: none"> » 4GB • 2GB • 1GB • 640MB • 512MB

#	Parameter Name	Description	Options
6	Scene Increment Mode	Selects which format the scene increments will use. To quickly increment a scene name press and hold the Headphone Encoder then slide the Transport Control right (Fast Forward)	» Disabled • Character • Numeric
7	Take Reset Mode	Defines when take numbers are reset. Reset brings take number to <1>	• Never • Scene Change • Daily Folder Change » Either Scene or Daily
8	File Playback Mode	Determines what (If any) playback action the 633 will perform upon reaching the end of a file during playback.	» Play Once • Play All • Repeat One • Repeat All
9	Default Playback Card	The source media that files will be played from when playback is initiated.	» CF • SD
10	Erase/Format CF	Formats CF card to FAT32 (32 GB or less) or exFAT (greater than 32 GB) file system.	
11	Erase/Format SD	Formats SD card to FAT32 (32 GB or less) or exFAT (greater than 32 GB) file system.	

System

#	Parameter Name	Description	Options
1	Slate Mic	Enable or disable the internal slate microphone.	• Off » On
2	Slate & Tone Routing	Displays the Slate and Tone Routing screen where the slate mic and tone signal can be routed to various destinations.	
3	Tone Level	The level of the 633's internal tone generator.	• 0-20 dBu (1 dBu increment) » 0 dBu
4	Tone Frequency	The audio frequency of the 633's internal tone generator.	• 100-10000 Hz (10 Hz increment) » 1000 Hz
5	Tone Mode	Continuous tone generates tone at the set tone level to all bus tracks. L Ident mode pulses the amplitude of tone to the Left channel of the Master Bus by -20dB.	» Continuous • L Ident
6	Warning Bell Level	The level of warning bell signals in the Headphones.	• Off, -60 to -12 dBFS (1dB increment) » -30 dBFS
7	Record/Stop Bell	Alerts the user with one beep at the start of recording and two beeps when the recording is stopped	• Off » On
8	Meter Ballistics	Selects among the two different meter ballistics settings.	• VU Only » Peak + VU • Peak Only
9	Meter Peak Hold Time	Adjusts the duration for which the peak indicator stays illuminated.	» 1 sec • 2 sec • 3 sec • 4 sec • 5 sec • Infinity • Off
10	Meter Display Style	The visual style of the meters. Segmented shows individual blocks separated by gaps and Solid shows a solid bar.	» Segmented • Solid

#	Parameter Name	Description	Options
11	Track Names In Meters	Toggle display and style/position of track names in meters.	» Off • Left • Left (w/ramp) • Right
12	Meter Views	Displays a submenu where each of the three available Meter Views can be selected. (Off option is available for second and third Meter View only)	• L,R,X1,X2,1-6 • L,R,1-6 • L,R,1-3 • L,R,X1-X4,RTN • Off
13	LED Brightness	Adjust the brightness of all LED's.	• 5-100% (5% increment) » 60%
14	LCD Brightness	Adjusts the brightness of the LCD backlight.	• 5-100% (5% increment) » 100%
15	LCD Daylight Mode	Toggle daylight visibility mode of user interface. Off displays a dark user interface suitable for low-light environments. On displays a bright user interface suitable for bright/sunny environments.	» Off • On
16	Time Format	Select 12 hour clock or 24 hour clock.	» 12hr • 24hr
17	Date Format	Select the format used to indicate the date.	» mm/dd/yy • dd/mm/yy • yy/mm/dd
18	Set Time/Date	Displays a dialog where the 633 time and date can be set. When highlighter is orange, turn Headphone Encoder to highlight a field and press Headphone Encoder to edit. When highlighter is blue, turn Headphone Encoder to change the value, and press Headphone Encoder to accept the value.	
19	Time Zone	Set the GMT time zone. (See <i>"Time Zone and Daylight Savings"</i> , page 51)	• (All GMT time zones) » GMT
20	Daylight Savings time	Set whether or not daylight savings is in effect.	• On » Off
21	Fader/Pan Calibration	Calibrates fader and pan positions. Set all faders and pans to center position and press OK.	
22	Headphone Encoder Mode	Toggle function of Headphone encoder for selecting Headphone Sources and adjusting headphone gain.	» Vol/Preset • Preset/Vol
23	Headphone Preset List	Choose which headphone presets are visible in the Headphone Source selection menu. Use the Headphone Encoder to toggle Presets. Presets highlighted in blue will be visible.	
24	USB Port		» Keyboard • Factory Test
25	Shortcut Info	Displays a list of all the 633 button shortcut combination for reference.	
26	Version Info	Displays firmware version information and Serial Number of the 633.	
27	Update Firmware	Searches connected media for .prg files and prompts to begin firmware update for each file found.	





Quick Setup

#	Parameter Name	Description	Options
1	Load Settings	Lists all available setup files found on attached media and on internal setup storage.	» Factory Default • Other available setups...
2	Save Settings to INT1	Saves settings to internal setup storage location 1.	
3	Save Settings to INT2	Saves settings to internal setup storage location 2	
4	Save Settings to INT3	Saves settings to internal setup storage location 3	
5	Save Settings to INT4	Saves settings to internal setup storage location 4	
6	Save Settings to CF	Saves settings to CF card.	
7	Save Settings to SD	Saves settings to SD card	

Front Panel Button Shortcuts

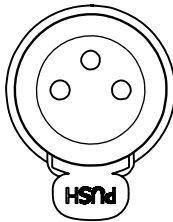
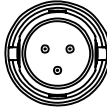
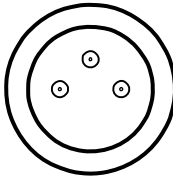
Function	Key Sequence	Action
False Take		Press and hold the Headphone Encoder then slide the Transport Control left (Rewind). Moves take to FALSETAKES folder and decrements take number.
Scene Increment		Press and hold the Headphone Encoder then slide the Transport Control right (Fast Forward). Increments the scene name according to the Scene Increment Mode (Setup Menu option FILE STORAGE > Scene Increment Mode)
Take List		Press and hold the Menu Button then press the Headphone Controller. Enters the Setup Menu.
Arm / Disarm Track		Press and hold the Meters Button then press the Select Encoder. Toggles the armed status of the highlighted track on the Main Screen.
Phrase List		Press and hold the Headphone Controller then slide the RTN / FAV Switch right. Accesses the phrase list and applies the selected phrase to the last take recorded (during standby) or the currently recording take (during recording).
Scene Name		Press and hold the Headphone Controller then slide the RTN / FAV Switch left. Edit the scene name. When used during record, edits the current scene name. When used during stop, edits the next scene name.
Alternate Tone Mode		Press and hold the Select Encoder then slide the Slate/Tone Switch right. Engages the tone with the alternate Tone Mode. The alternate Tone Mode is the mode that Setup Menu option SYSTEM > Tone Mode is <i>not</i> set to.
Toggle Playback Card		Press and hold the Headphone Encoder then slide the Transport Control down (Play). Changes the target media between SD or CF. Target media is indicated by a green background on the Main Screen.
LED Brightness		Press and hold the Menu Button then rotate the Headphone Encoder. Adjusts the brightness of all LED's.
LCD Brightness		Press and hold the Menu Button then rotate the Select Encoder. Adjusts the backlight level of the LCD.
LCD Daylight Mode		Press and hold the Headphone Encoder then press the Select Encoder. Toggles between standard and Daylight mode of User Interface.
Frame rate / Sample rate display toggle		Press and hold the Meters Button then slide the RTN / FAV Switch left. Toggles display of Timecode frame rate information and Audio sample rate information between Main Screen and RTN Screen.

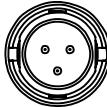
Connector Pin Assignments

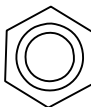
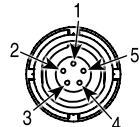
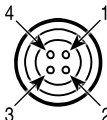
Connector	Pin Assignments	Notes
(3) XLR-3F Analog Inputs 1-3 AES3 Digital Input 1		1 – ground 2 – signal (+) 3 – signal (-) Mic- and Line-level balanced. For unbalanced, pin 1 and pin 3 tied together = ground, pin 2 = positive. Channel 1 AES3 Digital Input: AES3 balanced or unbalanced.
(3) TA3M Inputs 4-6		1 – ground 2 – signal (+) 3 – signal (-) Active balanced inputs 4-6. For unbalanced, pin 1 = ground, pin 2 = positive, pin 3 = tie to pin 1. Mates with Switchcraft TA3F-type connector.
(2) XLR-3M Master Outputs/ AES Outputs		1 – ground 2 – signal (+) 3 – signal (-) Output Level is selectable via menu between Mic, -10 dB, or Line-level. For unbalanced, float pin 3. Balanced AES3 Out A,B on XLR-3M connectors, 110 ohm, 2 V p-p, AES3 and S/PDIF compatible with RCA adaptor.
(1) 3.5 mm RTN		tip – signal L ring – signal R sleeve – signal ground Mates with 3.5 mm TRS jack. Signal is unbalanced.
(2) TA3M X1, X2 Outputs		1 – ground 2 – signal (+) 3 – signal (-) Active balanced, output level is selectable in Setup Menu as Line, -10, or Mic level. For unbalanced, pin 1 = ground, pin 2 = positive, pin 3 = float (no connect). Mates with Switchcraft TA3F-type connector.
(1) 3.5 mm X3, X4 Output		tip – signal L ring – signal R sleeve – signal ground Mates with 3.5 mm TRS jack. Signal is unbalanced.
(1) 1/4-inch Female Headphone		tip – signal L ring – signal R sleeve – signal ground Mates with 1/4-inch TRS jack.
(1) 5-pin LEMO Timecode		1 – ground 2 – SMPTE TC In 3 – ASCII in/out 4 – tuning out 5 – SMPTE TC out LEMO B-series connector, pin assignments as viewed on panel-mounted connector
(1) Hirose 4-pin DC Input		1 – ground 2 – not connected 3 – not connected 4 – DC (+) 10-18 Volt DC input. Mates with Sound Devices XL-NPH and XL-WPH3 powering accessories. See Accessories for details.

Specifications

Analog Inputs

Frequency Response	· 10 Hz to 40 kHz \pm 0.5 dB, -3dB @ 65 kHz (192 kHz sample rate, re 1 kHz)
THD + Noise	· 0.09% max (1 kHz, 22 Hz–22 kHz BW, fader at 0, 0 dBu output)
Equivalent Input Noise	· -126 dBu (-128 dBV) maximum. (22 Hz - 22 kHz bandwidth, flat filter, trim control fully up)
Input Type	<ul style="list-style-type: none"> · XLR-3F Mic: Active-balanced for use with \leq600 ohm mics · XLR-3F Line: Active-balanced for use with \leq2k ohm outputs · RTN (3.5 mm): Unbalanced stereo for use with \leq2k ohm outputs
Input Impedance (ohms actual)	<ul style="list-style-type: none"> · XLR-3F Mic: 4k ohms · XLR-3F Line: 10k ohms · RTN (3.5 mm): 15k ohms
Input Clipping Level	· 0 dBu minimum (trim control fully down)
Maximum Input Level	<ul style="list-style-type: none"> · XLR-3F Mic: 0 dBu (0.78 Vrms) · XLR-3F Line: +40 dBu (80 Vrms) · RTN (3.5 mm): +24 dBu (12.4 Vrms)

High-Pass Filters Sweepable 80 Hz to 240 Hz, 12 dB/oct at 80 Hz, 6 dB/octave at 240 Hz

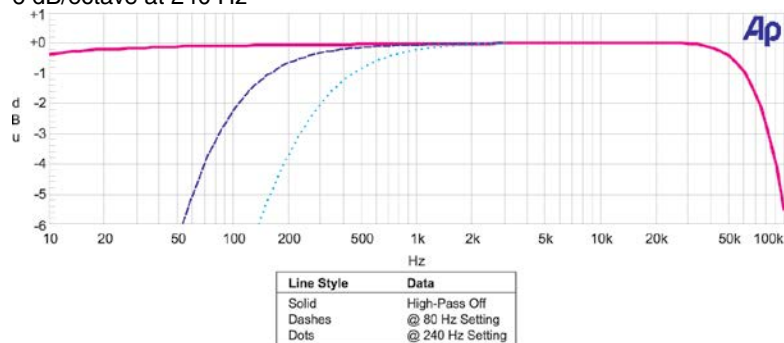

Microphone Powering (each analog Input selectable)

- 12 V Phantom: through 680 ohm resistors, 10 mA per mic available
- 48 V Phantom: through 6.8k resistors, 10 mA per mic available

Pre-Fader Input Limiters (Inputs 1-3)

- Affects the output of the mic preamps only ('Trim' stage)
- +16 dBu threshold (fixed)
- 20:1 limiting ratio
- 1 mS attack time
- 500 mS release time.

Post-Fader Input Limiters (Inputs 1-6)

- +4 dBu to +18 dBu threshold (adjustable)
- 20:1 limiting ratio
- 1 mS attack time
- 500 mS release time.

Digital Inputs

AES3	· Balanced: 110 ohm
AES42	· AES42 Mode 1, provides +10 V Digital Phantom Power
Post-Fader Digital Limiters	<ul style="list-style-type: none"> · +4 dBu to +18 dBu threshold (adjustable) · 20:1 limiting ratio · 1 mS attack time · 500 mS release time.

Analog Outputs

Output Type	<ul style="list-style-type: none"> · XLR-3M Line: Active Balanced for use with ≥ 600 ohm inputs · XLR-3M -10: Active Balanced for use with $\geq 10k$ ohm inputs · XLR-3M Mic: Active Balanced for use with ≥ 600 ohm inputs · TA3 Active Balanced Mic/Line: pin-2 and 3 driven, for use with $\geq 3k$ ohm inputs · X3,X4 (3.5 mm): Unbalanced, stereo, for use with $\geq 6k$ ohm inputs · Headphones (1/4"): Unbalanced, stereo, for use with 8-2k ohm headphones 																								
Output Impedance (ohms actual)	<ul style="list-style-type: none"> · XLR-3M and TA3 balanced outputs: 100 ohms at Line setting, 3.2k ohms at -10 setting, 150 ohms at Mic setting · TA3 Balanced Outs: 1k ohms at Mic and Line settings · X3,X4 (3.5 mm): 100 ohms · Headphones (1/4"): 100 ohms 																								
Line Output Clipping Level (1% THD)	<ul style="list-style-type: none"> · 20 dBu minimum with 10k load 																								
Maximum Output Level	<ul style="list-style-type: none"> · Line (XLR-3M, 10-pin Hirose, TA3 Balanced and Direct Outs): +20 dBu (7.8 Vrms) · -10 (XLR-3M, 10-pin Hirose): +6 dBu (1.5 V rms) · Mic (XLR-3M, 10-pin Hirose, TA3 Balanced and Direct Outs): -20 dBu (0.078 Vrms) 																								
Output Limiters	<ul style="list-style-type: none"> · Affects the outputs of the mixer. · Threshold selectable from +4 dBu to +18 dBu, 1 dB steps · 20:1 limiting ratio · 1 mS attack time · 500 mS release time. 																								
Maximum Gain Typical (Trim, Fader, Master, Phones, RTN fully up)	<table border="1"> <thead> <tr> <th></th> <th>MIC Level Input</th> <th>LINE Level Input</th> <th>RTN</th> </tr> </thead> <tbody> <tr> <td>Master Outs (XLR-3M) @ LINE</td> <td>91 dB</td> <td>51 dB</td> <td>-</td> </tr> <tr> <td>Master Outs (XLR-3M) @ -10</td> <td>77 dB</td> <td>37 dB</td> <td>-</td> </tr> <tr> <td>Master Outs (XLR-3M) @ MIC</td> <td>51 dB</td> <td>11 dB</td> <td>-</td> </tr> <tr> <td>X3, X4 Outs (3.5 mm)</td> <td>77 dB</td> <td>37 dB</td> <td></td> </tr> <tr> <td>Headphones (1/4")</td> <td>107 dB</td> <td>67 dB</td> <td>5 dB</td> </tr> </tbody> </table>		MIC Level Input	LINE Level Input	RTN	Master Outs (XLR-3M) @ LINE	91 dB	51 dB	-	Master Outs (XLR-3M) @ -10	77 dB	37 dB	-	Master Outs (XLR-3M) @ MIC	51 dB	11 dB	-	X3, X4 Outs (3.5 mm)	77 dB	37 dB		Headphones (1/4")	107 dB	67 dB	5 dB
	MIC Level Input	LINE Level Input	RTN																						
Master Outs (XLR-3M) @ LINE	91 dB	51 dB	-																						
Master Outs (XLR-3M) @ -10	77 dB	37 dB	-																						
Master Outs (XLR-3M) @ MIC	51 dB	11 dB	-																						
X3, X4 Outs (3.5 mm)	77 dB	37 dB																							
Headphones (1/4")	107 dB	67 dB	5 dB																						

Digital Outputs/Recorder

AES3 Output:	<ul style="list-style-type: none"> · AES Out A,B on XLR-3M · 110 ohm, 2 V p-p, AES and S/PDIF compatible with RCA adaptor
Sampling Frequency	<ul style="list-style-type: none"> · 44.1 kHz · 47.952 kHz · 48 kHz · 48.048 kHz · 88.2 kHz · 96 kHz · 192 kHz
A/D	<ul style="list-style-type: none"> · 24 bit
A/D Dynamic Range	<ul style="list-style-type: none"> · 114 dB, A-weighted, typical
Input to Output Delay	<ul style="list-style-type: none"> · 0.74 ms (XLR-3F analog input to XLR-3M analog output, Input and Output delays set to 0, Sample rate set to 48 kHz)
Media Type	<ul style="list-style-type: none"> · Secure Digital Extended Capacity (SDXC) · Secure Digital High Capacity (SDHC) · Secure Digital (SD) · CompactFlash (CF) · FAT32 or exFAT formatted, will format media on-board
File Type	<ul style="list-style-type: none"> · Record: WAV (Broadcast Wave File format), polyphonic or MP3 · Playback: WAV (Broadcast Wave File format), polyphonic or MP3

Sampling Clock Accuracy · ± 0.2ppm

Timecode and Sync

Modes Supported

- Off
- Rec Run
- Free Run
- 24h Run
- External

Frame Rates

- 23.976
- 24
- 25
- 29.97DF
- 29.97ND
- 30DF
- 30ND

Accuracy

- Ambient Generator
- 0.2ppm (0.5 frames per 24 hours) accuracy.
- Holds TC clock for two hours after main battery removal

Input

- 20k ohm impedance
- 0.3 V - 3.0 V p-p (-17 dBu - +3 dBu)

Output

- Output: 1k ohm impedance
- 3.0V p-p (+12 dBu)

Power

External Power Supply

- 10-18 V Locking 4-pin Hirose connector, pin-4 = (+), pin-1 = (-)
- Mates with gold Hirose #HR10A-7P-4P (DigiKey# HR110-ND) or silver Hirose #HR10-7P-4P (DigiKey# HR100-ND) locking connector.

Internal Power Supply

- 5-10 V range.
- Accepts 6 AA-sized (LR6) batteries (NiMH rechargeable recommended).
- There are similar sized 3+ V Lithium-cells that are not compatible.

Idle Current Draw · 447 mA @ 12V (5.36 W) - Inputs 1-6 powered on, CF and SD media.

Environmental

Operation and Storage

- Operating: -20°C to 60°C
- Storage: -40°C to 85°C
- 0 to 90% relative humidity (non-condensing)

Dimensions and Weight

Size (H x W x D)





- 5.6 cm x 23.8 cm x 14.3 cm
- 2.2 in. x 9.4 in. x 5.6 in.

Weight · 2 lbs. 9.4 oz. (unpackaged, without batteries)

Accessories

Several high-value accessories are available for the 633, including production cases, cables, and power accessories. For a full list of Sound Devices products and accessories, visit our web site www.sounddevices.com/products.

Optional 633 Related Accessories

<p>CS-633</p> 	<p>Production case for use with the 633 Field Production Mixer. Front pocket provides space for wireless receivers and/or NP-1 battery. Bottom panel opens and expands to provide access to rear-mounted L-Series batteries. By PortaBrace for Sound Devices.</p>
<p>Wave Agent Beta</p> 	<p>Sound Devices Wave Agent file librarian for Mac OS and Windows computers. Wave Agent provides a comprehensive and indispensable range of tools for preparing audio files for problem-free passage through complex production workflows. For more details and download visit www.waveagent.com.</p>
<p>XL-1B</p>	<p>12-inch TA3F to TA3F cable, connects TA3 Aux outputs to TA3 inputs of receiving devices such as the Sound Devices 788T's analog inputs 5-8. Also connects TA3 balanced outputs of other devices to balanced, line inputs of 633.</p>
<p>XL-2</p>	<p>25-inch TA3F to XLR-3M cable, used to connect 633 TA3 Aux outputs to third-party devices with XLR-3F inputs; package of two.</p>
<p>XL-2F</p>	<p>25-inch XLR-3F to TA3F cable, used to connect mixers and other devices with XLR-3M outputs to the 633 TA3 4-6 inputs; package of two.</p>
<p>XL-4</p>	<p>Bag of four (4) TA3-F-type connectors.</p>
<p>XL-H</p>	<p>Bare Hirose 4-pin locking DC connector (HR10-7P-4P).</p>
<p>XL-NPH</p> 	<p>NP-type battery cup with 24-inch cable terminated in Hirose 4-pin locking DC connector (HR10-7P-4P) at equipment end.</p>
<p>XL-WPH3</p> 	<p>AC to DC Power Supply (in-line) 100 - 240V 50/60 Hz input, 12 VDC 3.75 A (45 W) output, Hirose 4-pin DC plug. Supplied with 3-pin IEC cord.</p>
<p>XL-B2</p>	<p>7.2 V, 4600 mAh L-Series battery. Connects to the 633's B1 and/or B2 battery connector.</p>
<p>XL-B3</p>	<p>7.2 V, 6600 mAh L-Series battery. Connects to the 633's B1 and/or B2 battery connector.</p>
<p>XL-LL</p>	<p>LEMO®-5 to-LEMO®-5 coiled-cable for time code interconnection between the 633 and other devices.</p>
<p>XL-LB2</p>	<p>LEMO®-5 to BCN input and BNC output for time code interconnection between the 633 and other devices.</p>
<p>XL-LX</p>	<p>LEMO®-5 to XLR3-F input and XLR3-M output for time code interconnection between the 633 and other devices.</p>

Wave Agent



Wave Agent Beta is a WAV file librarian for Mac OS and Windows computers. Designed for Production Sound Mixers and Post Production Editors, Wave Agent provides a comprehensive and indispensable range of tools for preparing audio files for problem-free passage through complex production workflows.

Wave Agent is an essential, time-saving tool for anyone working in Production Sound. It allows for the following;

- Playback of polyphonic and monophonic WAV and Broadcast Wave files from any source
- Viewing and editing file metadata
- Changing of sampling rate, frame rate, and start timecode metadata stamps
- Splitting and combining polyphonic and monophonic files with selectable track assignments
- Batch editing
- Generating customized PDF and CSV Sound Reports
- Large timecode display
- Monitor mixer with faders, pans, solos, mutes, and meters
- Drag-and-drop operation
- Comprehensive keyboard shortcuts for accelerated operation
- Mac OS and Windows compatible

Wave Agent is available as a no-charge software download for either Mac OS or Windows.
<http://www.sounddevices.com/products/waveagent/>

Index

A

AES 2, 4, 16, 17, 26, 27, 30, 34, 58, 59, 66, 68
 AES3 3, 12, 14, 16, 17, 27, 58, 66, 68

AES42 3, 12, 14, 16, 17, 67
 AUX 3/4 Output 3

B

ballistics 12, 20, 62

bEXT 34, 39, 40, 41, 42, 43, 47

C

CF 8, 9, 10, 31, 32, 35, 38, 39, 44, 57, 59, 61, 62, 64, 65, 68 CompactFlash 4, 31, 35, 38, 68

E

exFAT 36, 38, 51, 62, 68

F

Fader 1, 11, 12, 14, 15, 16, 18, 21, 24, 27, 31, 32, 58, 63, 67, 68, 71

frame rate 10, 36, 37, 42, 43, 47, 49, 60, 65, 71

H

Headphone Clipping LED 2, 21
 Headphone Output 4, 55
 Headphone Source 2, 8, 11, 12, 22, 23, 24, 25, 27, 30, 56

High-pass Filter 17
 HPF 11, 12, 17

I

Input Activity LED 1, 19, 21
 Input Meter 11, 12
 Input Polarity 11, 12
 Input Select Switch 1, 7, 11, 14, 24, 25, 33
 Input Settings Screen 1, 2, 3, 7, 11, 12, 14, 15, 16, 17, 22,

24, 25, 26, 32, 33, 56
 Input Source 12
 Input Trim 12, 15
 ISO 12, 14, 24, 26, 27, 31, 32, 37, 58, 74
 iXML 34, 39, 40, 41, 42, 44, 47

L

LCD Daylight Mode 13, 63, 65
 Limiter Knee 19

Line Inputs 3
 L-Series 4, 52

M

Main Screen 1, 2, 5, 7, 9, 10, 18, 19, 20, 22, 23, 24, 25, 31, 33, 35, 37, 51, 53, 56, 61, 65
 Menu Button 2, 8, 33, 35, 44, 45, 46, 49, 54, 56, 57, 65
 metadata 32, 33, 34, 38, 39, 40, 41, 42, 43, 44, 45, 46, 51, 71
 Meters Button 1, 2, 9, 10, 24, 25, 28, 32, 47, 49, 65

Meter Style 10
 Meter View 10, 11, 25, 28, 47, 49, 63
 Mic / Tone Switch 2, 12, 13, 14, 26, 29
 MP3 31, 32, 34, 35, 37, 39, 41, 42, 43, 59, 60, 68
 M/S 18, 23, 24

P

Pan 1, 14, 15, 18, 63, 71
 PFL 1, 11, 14, 16, 21, 24, 25, 33, 37, 58
 phantom power 3, 7, 14, 16, 58, 67

polarity 17
 Power LED 2
 PowerSafe 52, 53, 54, 55

Power Switch 2, 5

R

RTN / FAV Switch 2, 10, 12, 13, 24, 26, 33, 36, 38, 39, 40, 44, 45, 46, 47, 57, 65

RTN Input 4, 25

S

sample rate 10, 17, 34, 35, 36, 37, 41, 42, 43, 47, 60, 61, 65, 68

SDHC 4, 31, 35, 68

SDXC 4, 31, 35

Slate Mic 2, 29, 62

Sound Report 39, 42, 43, 44, 61

T

Take List 33, 37, 38, 41, 43, 44, 45, 46, 56, 61, 65

timecode 1, 2, 3, 10, 36, 42, 43, 44, 47, 48, 49, 50, 51, 60, 61, 65, 66, 69, 71

Timecode LED 2

Tone Oscillator 2, 29

Track Name 11, 12, 20, 33, 40, 42

Transport Control 1, 9, 31, 37, 45, 46, 48, 62, 65

U

USB 3, 24, 33, 56, 63

V

VU 12, 20, 21, 62

W

Wave Agent 47, 70, 71

X

X1 2, 4, 10, 11, 12, 14, 19, 26, 28, 29, 31, 32, 34, 40, 47, 56, 58, 59, 63, 66

X2 2, 4, 10, 12, 14, 19, 26, 28, 29, 31, 32, 34, 40, 49, 56, 58, 59, 63, 66

X3 2, 14, 15, 26, 27, 28, 29, 49, 59, 66, 68

X4 2, 11, 14, 15, 26, 27, 28, 29, 47, 49, 59, 63, 66, 68

SOUND  **DEVICES****Declaration of Conformity**

According to EN ISO/IEC 17050-1:2004

Manufacturer's Name: Sound Devices, LLC
Manufacturer's Address: E7556 State Rd. 23 and 33
 Reedsburg, WI 53959
 USA

Declares under sole responsibility that the product as delivered

Product Name: 633 Field Mixer with Integrated Recorder
Model Number: 633
Product Options: This declaration covers all options of the above products

complies with the essential requirements of the following applicable European Directives, and carries the CE marking accordingly:

EMC Directive (2004/108/EC)
 EN 55022:2010
 EN 55103-2:2009

First date of CE approval July 18, 2013.

This Declaration of Conformity applies to the above-listed products placed on the EU market after:

July 18, 2013

Date



Matt Anderson
 Director of Engineering

Warranty and Technical Support

Warranty & Service

Sound Devices, LLC warrants the 633 against defects in materials and workmanship for a period of TWO (2) years from date of original retail purchase.

This is a non-transferable warranty that extends only to the original purchaser. Sound Devices, LLC will repair or replace the product at its discretion at no charge. Warranty claims due to severe service conditions will be addressed on an individual basis.

THE WARRANTY AND REMEDIES SET FORTH ABOVE ARE EXCLUSIVE. SOUND DEVICES, LLC DISCLAIMS ALL OTHER WARRANTIES, EXPRESS OR IMPLIED, INCLUDING WARRANTIES OF MERCHANTABILITY AND FITNESS FOR A PARTICULAR PURPOSE.

SOUND DEVICES, LLC IS NOT RESPONSIBLE FOR SPECIAL, INCIDENTAL, OR CONSEQUENTIAL DAMAGES ARISING FROM ANY BREACH OF WARRANTY OR UNDER ANY OTHER LEGAL THEORY. Because some jurisdictions do not permit the exclusion or limitations set forth above, they may not apply in all cases.

For all service, including warranty repair, please contact Sound Devices for an RMA (return merchandise authorization) before sending your unit in for repair. Product returned without an RMA number may experience delays in repair. When sending a unit for repair, please do not include accessories, including SSD drives, CF cards, batteries, power supplies, carry cases, cables, or adapters unless instructed by Sound Devices.

Sound Devices, LLC
Service Repair RMA #XXXXX
E7556 State Road 23 and 33
Reedsburg, WI 53959 USA
telephone: (608) 524-0625

Technical Support / Bug Reports

For technical support and bug reporting on all Sound Devices products contact:

Sound Devices, LLC
E-mail: support@sounddevices.com
web: www.sounddevices.com/support/
Telephone: +1 (608) 524-0625 / Toll-Free in the U.S.A.: (800) 505-0625
Fax: +1 (608) 524-0655

Sound Devices hosts a user support forum. The URL is:

<http://forum.sounddevices.com>

Sound Devices cannot guarantee that a given computer, software, or operating system configuration can be used satisfactorily with the 633 based exclusively on the fact that it meets our minimum system requirements.

SOUND **DEVICES**