

GSI 70 User Manual



Part Number 1770-0100 Rev A

Title: GSI 70
Automated OAE Screener
User Manual

Date: November 2009

Copyright © 2005 All rights reserved. No part of this publication may be reproduced or transmitted in any form or by any means without the prior written permission of
The information in this publication is proprietary to

Part number: 1770-0100

Printing history:

August, 1999	First printing	Rev 1.0	
January, 2000	Second printing	Rev 2.0	
February, 2001	Third printing	Rev 3.0	
February, 2003	Fourth printing	Rev 4.0	
September, 2003	Fifth printing	Rev 5.0	
March, 2004	Sixth printing	Rev 6.0	DCO 1770-0303
March, 2005	Seventh printing	Rev 7.0	DCO 1770-0302

Electromagnetic compatibility (EMC)

Please refer to the Electromagnetic Compatibility Reference Guide on CD (part number 482-6387xx) for EMC information concerning your system.

Compatibilité électromagnétique (CEM)

Veuillez vous reporter au guide de référence de compatibilité électromagnétique sur CD (numéro de pièce 482-6387xx) pour des informations sur la CEM relatives à votre système.

Elektromagnetische Verträglichkeit (EMV)

Informationen über die EMV des Systems finden Sie im Referenz-Handbuch Elektromagnetische Verträglichkeit auf der CD (Teilenummer 482-6387xx).

Compatibilità elettromagnetica (EMC)

Vedere la guida alla consultazione per la compatibilità elettromagnetica contenuta sul CD (numero di parte 482-6387xx) per informazioni sulla compatibilità elettromagnetica relativa al sistema in dotazione.

Compatibilidad electromagnética (CEM)

Consulte la Guía de referencia sobre compatibilidad electromagnética incluida en el CD (número de pieza 482-6387xx) para obtener la información sobre la CEM de su sistema.

Electromagnetic compatibility (EMC)

Please refer to the Electromagnetic Compatibility Reference Guide on CD (part number 482-6387xx) for EMC information concerning your system.

电磁兼容性 (EMC)

有关系统的 EMC 信息, 请参阅 CD 上的电磁兼容性 (EMC) 参考指南 (部件号 482-6387xx)。

電磁適合性 (EMC)

お使いのシステムに関する EMC 情報については、CD (パーツ番号 482-6387xx) の『電磁適合性 (EMC) リファレンスガイド』を参照してください。

전자파적 합성 (EMC)

시스템에 관한 EMC 정보는 CD의 『전자파적합성(EMC) 가이드』(부품 번호: 482-6387xx)를 참조하십시오.

Compatibilidade Eletromagnética (EMC)

Favor consultar o Guia de Referência à Compatibilidade Eletromagnética no CD (número de peça 482-6387xx) para informações da EMC relativas ao seu sistema.

Addenda

Addendum to Chapter 4: Using the GSI 70 Single-Patient Screener

Two default protocols are available:

- OAE 1: GSI Default
- OAE 4: 2 OUT OF 3

Selecting a Protocol

1. Turn the GSI 70 Automated OAE Screener on by pressing any button. (The Screener can be in the Printer/Charger cradle during this procedure.)
2. When the DPGRAM appears on the display, simultaneously press the LEFT (blue) and RIGHT (pink) buttons to enter the UTILITY MENU.
3. Use the down arrow button (blue) to highlight CHANGE PROTOCOL. The Select Protocol screen appears.
4. Use the down arrow button (blue) or up arrow button (pink) to highlight either:
 - OAE 1: GSI Default or
 - OAE 4: 2 OUT OF 3

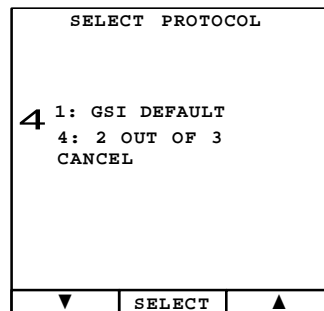

Once highlighted, press the SELECT button (green) to choose the desired protocol.

5. The UTILITY MENU is now displayed. Use the down arrow button (blue) or up arrow button (pink) to scroll to and highlight the word EXIT. Press RUN to return to the DPGRAM screen.



The label to the right of the Pass/Refer line indicates the protocol being used once the TEST (green) button is pressed.

Protocol Scoring Rules

OAE 1: GSI Default

- Scores the test result as PASS when all three responses are at or above the Pass/Refer line and each response is individually scored as a Pass.
- Scores the test result as REFER when at least one response is below the Pass/Refer line and its response is individually scored as a Refer.
- Scores the test result as NOISE when at least one response is individually scored as noise.

OAE 4: 2 OUT OF 3

- Scores the test result as PASS when at least 2 out of 3 responses are at or above the Pass/Refer line and these 2 responses are individually scored as Pass.
- Scores the test result as REFER when at least 2 out of 3 responses are below the Pass/Refer line and these 2 responses are individually scored as Refer.
- Scores the test result as NOISE when at least 2 out of 3 responses are individually scored as Noise.
- If one response is PASS, one is REFER, and one is NOISE, the test result is scored as NOISE.



Selection of protocol OAE 1 versus OAE 4 depends upon the program's performance objective for hearing screening.



It is possible to save and print one ear with OAE 1 and the other ear with OAE 4.

Addendum to Chapter 5: Using the GSI 70 Multi-Patient Screener

Two default protocols are available:

- OAE 1: GSI Default
- OAE 4: 2 OUT OF 3

Selecting a Protocol

1. Turn the GSI 70 Automated OAE Screener on by pressing any button. (The Screener can be in the Printer/Charger cradle during this procedure.)
2. Once the DPGRAM appears on the display, simultaneously press the NAME (blue) and DATA (pink) buttons to enter the UTILITY MENU screen.
3. Use the down arrow button (blue) to select CHANGE PROTOCOL. The Select Protocol screen appears.
4. Use the stylus to select either the GSI Default (OAE1) or the 2 OUT OF 3 (OAE4) protocol. Once highlighted, press SELECT to activate this protocol and return to the Utility Menu screen.

SELECT PROTOCOL (OAE)		
CANCEL		
1: GSI DEFAULT		
4: 2 OUT OF 3		
: EMPTY		
: EMPTY		
: EMPTY		
ERASE	SELECT	LOAD

The first 2 positions on this CHANGE

PROTOCOL screen are now reserved for factory default protocols. Both protocol positions cannot be overwritten by a user-defined protocol. The three remaining protocol positions may be used to store user-defined protocols and may be overwritten.



The OAE 4 protocol is loaded into the GSI 70 DMS program when the first results for OAE 4 are collected from the Screener.



5. Scroll to the word EXIT by using the down arrow button (blue) or up arrow button (pink) and press RUN (green button) to return to the DPGRAM display.



The label to the right of the Pass/Refer line indicates the protocol being used once the TEST (green) button is pressed.

Protocol Scoring Rules

OAE 1: GSI Default

- Scores the test result as PASS when all three responses are at or above the Pass/Refer line and each response is individually scored as a Pass.
- Scores the test result as REFER when at least one response is below the Pass/Refer line and its response is individually scored as a Refer.
- Scores the test result as NOISE when at least one response is individually scored as noise.

OAE 4: 2 OUT OF 3

- Scores the test result as PASS when at least 2 out of 3 responses are at or above the Pass/Refer line and these 2 responses are individually scored as Pass.
- Scores the test result as REFER when at least 2 out of 3 responses are below the Pass/Refer line and these 2 responses are individually scored as Refer.
- Scores the test result as NOISE when at least 2 out of 3 responses are individually scored as Noise.
- If one response is PASS, one is REFER, and one is NOISE, the test result is scored as NOISE.



Selection of protocol OAE 1 versus OAE 4 depends upon the program's performance objective for hearing screening.



If the results for the left and right ears are run with both default protocols OAE 1 and OAE 4), the right and left ear results will be paired for printout in the time sequence that they were acquired.

Sample Printouts

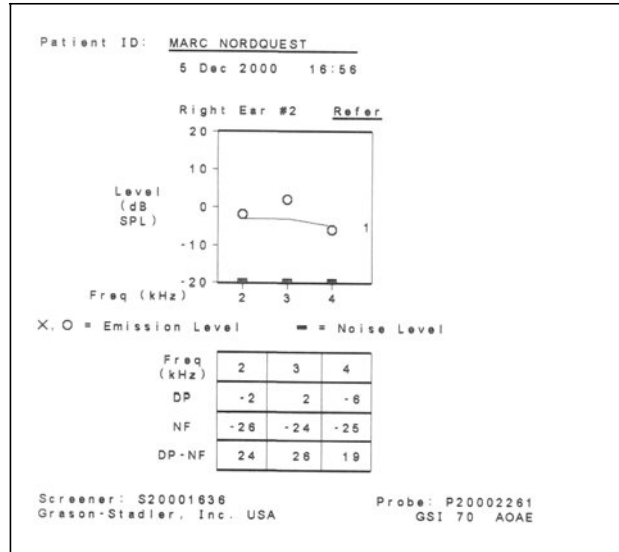

OAE 1: GSI Default

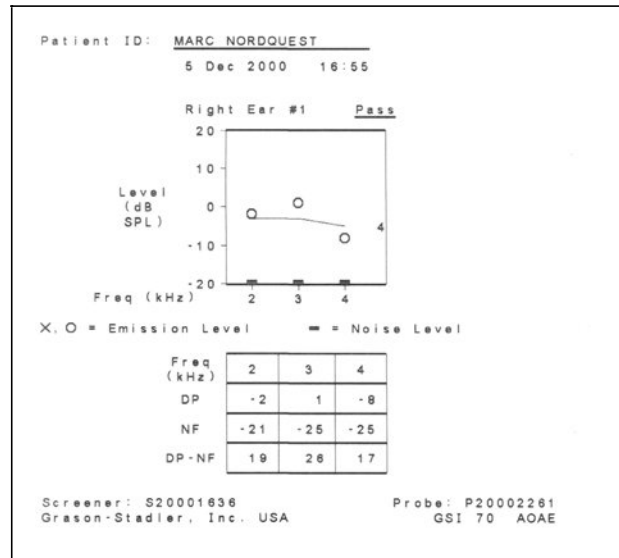

OAE 4: 2 OUT OF 3

Addenda

Contents

1	Introduction	1
	Product Information	1
	About This Manual	2
	Conventions	2
	Product Symbols	3
2	Getting Started	5
	Unpacking and Verifying Contents	5
	Precautions	6
	Automated OAE Screener Features	7
	Printer/Charger Features	8
	Setting Up the Automated OAE Screener	10
	Installing the battery	10
	Setting the Screener date and time	10
	Attaching the Footswitch to the Screener	10
	Mounting the Screener or Printer Charger to the optional Rolling Stand	10
	Checking the Battery	11
	Adjusting the LCD Contrast	11
	Installing the GSI 70DMS Software into your Computer	12
	Connecting the Optional Infrared (IrDA) Adapter to a Computer	12
	Setting Up the Printer/Charger	12
	Connecting the Printer/Charger to Mains Power	13
	Connecting the Printer/Charger to a Computer	13
	Preparing for a Test	14
	Selecting an Eartip	14
	Attaching an Eartip to the Probe Tip	15
	Securing the Pod and Probe to the Screener	16

3	Understanding the display	17
	Common Displays	17
	Power-Up Display.....	17
	Version Information	17
	Blank DPGram	18
	Completed DPGram	19
	Stored DPGram.....	20
4	Using the GSI70 Single-Patient Screener	21
	Checking the Screener's Performance	21
	Running a Test	22
	Message CHECK SEAL	23
	Storing a Test	24
	Reviewing a Test.....	24
	Printing a Test	24
	Contents of the Printout	25
	Canceling the Printout	26
	Advancing the Paper	26
	Stopping a Test	26
	Erasing a Test.....	26
	Power-Saving Mode	27
	Power-Down	27
	Low-Battery Icon	28
	Battery Discharge Time	28
5	Using the GSI70 Multi-Patient Screener	29
	Setting Up the Screener	30
	Setting the Screener's Date and Time	30
	Transferring a Patient List from the Computer	30
	Entering Patient Names or ID Numbers from the Screener.....	31
	Selecting a Patient from the List.....	33
	Erasing a Patient Name from the List	34

Selecting a Test Protocol	34
Transferring a New Test Protocol from the Computer	35
Deleting a Test Protocol.....	35
Testing Patients	37
Running a Test	37
Message CHECK SEAL	38
Stopping a Test	38
Storing a Test	38
Managing the Test Results	39
Sending Test Results to the GSI 70 DMS	39
Erasing a Test	41
Reviewing a Test.....	42
Printing a Test	43
Printing All Tests for a Patient	44
Printing Selected Tests	44
Printing Individual Test Results.....	45
Contents of the Printout	45
Canceling the Printout	47
Advancing the Paper	47
Power-Saving Mode	47
Power-Down	47
Low Battery Icon	48
Battery Discharge Time	48
6 Reviewing the Test Results	49
Test Result PASS	49
Test Result REFER	50
Test Result NOISE.....	51
Test Result ABORT	52

7	Maintenance	51
	Setting the Date and Time (GSI 70 Multi-Patient Screener Only)	53
	Setting the Date and Time from the Computer	53
	Setting Date and Time Using the Touchscreen	54
	Cleaning	56
	Cleaning the Housings, Display, and Cables	56
	Cleaning the Probe Tips.....	56
	Removing the Probe Tip	57
	Cleaning the Probe Tip	57
	Attaching the Probe Tip to the Probe.....	58
	Cleaning the Infrared Port Windows and Charging Contacts ..	58
	Recharging the Battery	59
	Removing or Replacing the Battery.....	60
	Disposing of the Battery	61
	Checking the Screener	62
	Running the Quick Check Test	62
	Quick Check Passed	63
	Quick Check Failed	63
	Calibrating the Touchscreen	64
	Checking the Printer/Charger	65
	Printing a Test Pattern	66
	About the Printer Paper	66
	When to Replace the Paper	67
	Replacing the Paper	67
8	Troubleshooting	69
	Error Codes	69
	Troubleshooting Tips	70
	Screener Problems	70
	What to Check First.....	70
	Printer/Charger Module Problems	74
	What to Check First.....	74

9	Guide to Otoacoustic Emmissions	75
	What are Otoacoustic Emissions?	77
	How is an OAE Generated and Detected?.....	77
	Testing with the GSI 70 Automated OAE Screener	77
10	Service and Warranty Information.....	79
	Warranty for the Screener and Printer/Charger.....	79
	Repair	79
	Technical Service Department	79
	Recalibration	80
11	Replacement Parts and Accessories.....	81
	Ordering Information	81
	Eartips	82
	Screener Parts and Accessories.....	83
	Printer/Charger Parts and Accessories	85
12	Specifications	87
	General Specifications	87
	GSI 70 Automated OAE Screener Specifications	91
	Charging Time	91
	Probe Tones and Test Protocol.....	91
	Eartips	91
	Display	92
	Dimensions	93
	DIP Switch Functions	94
	Changing the Language Setting for the Screener	94
	Printer/Charger Specifications	96
	Dimensions	96
	Plain Paper	96
	Adhesive-Backed Paper	96

Optional Charging Transformer Specifications	97
Dimensions	98
Index	Index-1

Thank you for purchasing the Grason-Stadler GSI 70 Automated OAE Screener.

The GSI 70 provides a quick, reliable way to screen for cochlear function, particularly among patients from birth to age four or five. This promotes earlier diagnostic testing and earlier intervention for those with cochlear hearing loss. The Screener offers the following features:

- Quickly evaluates cochlear function
- Displays results as they happen
- Stores data from two ears before printing (Single-Patient Model)
- Prints out hardcopy on demand
- Electronically stores test results in database (Multi-Patient Model)

The Printer/Charger Module prints data stored in the GSI 70 and charges the rechargeable battery in the GSI 70. The Printer/Charger is sometimes referred to as the Printer/Charger Module (PCM).

This manual describes how to operate and maintain the GSI 70 and Printer/Charger. Please follow these instructions to ensure many years of accurate and reliable service.

For additional information on the technology used in the GSI 70, see the *Guide to Otoacoustic Emissions* on page 77.

Product Information

For future reference, record the Screener's serial number here.

The serial number is printed on a label on the back of the instrument, and has the following format: 1999 0914 where the first four digits are the year of manufacture and the next digits are a unique product number assigned by the factory.

About This Manual

This manual assumes a certain level of medical knowledge, particularly how to perform tests on infants and small children. Some of the newborns that will be tested with this instrument may be cared for in a Neonatal Intensive Care Unit (NICU) and may have been born quite premature. In addition, we assume that you have used other medical screening devices and are familiar with a graphical interface and using buttons to select different options.

Conventions

Throughout this manual, the following typeface: `EXAMPLE OF MESSAGE` indicates the following items:

- Messages that appear on the Screener LCD display
- Names of buttons and LEDs on the Screener and the Printer/Charger

Messages that appear on the printouts from the Printer/Charger appear in *Courier*. This manual also uses icons and symbols, described below.



Provides important related information, reminders, recommendations, and suggestions.



Indicates patient safety alerts. Also indicates that a specific action could cause harm to your instrument or result in lost data.





Indicates an electrical danger to you or a patient. Follow the guidelines in the manual or on the instrument itself when handling electrical equipment.

Product Symbols

The symbols on the GSI 70 Automated OAE Screener and Printer/Charger Module (PCM) are defined below.

Table 1 – Product Symbols

Symbol	Means
	Refer to User Manual.
	Disconnect from the Mains.
	Disassembly of the Screener, Probe/Pod, or Printer/Charger beyond the extent described in this manual voids the warranty. Refer all servicing to Grason-Stadler or a Grason-Stadler Authorized Service Representative.
	Charge the Screener battery only in the Printer/Charger or with the specified Charging Transformer. Do not use either the Printer/Charger or the Charging Transformer with any other instruments.
	Disassembly of the Printer/Charger presents a possible electrical shock hazard. Refer all servicing to Grason-Stadler or a Grason-Stadler Authorized Service Representative.

Unpacking and Verifying Contents

Inspect the packaging for any damage incurred during shipping. If you find any damage, notify the carrier. Complete and return the warranty registration card. It validates the warranty and allows Grason-Stadler to send announcements of product enhancements.

When you unpack your new GSI 70 Automated OAE System, verify that the following items are included:

- Automated OAE Screener
- Screener battery
- User Manual (this document)
- Quick-Reference Guide
- Starter Kit, Single-Use Eartips
- Quick Check Cavity
- Cleaning Kit
- Calibration Certificate
- Videotape and Training Booklet
- Printer/Charger Module
- Two rolls of paper (one thermal paper, one adhesive backed)
- Hospital-grade Power Cord to connect the Printer/Charger to Mains outlet

In addition, you may have some of the following, depending on the system and optional components you purchased:

- Charging Transformer, for systems with no Printer/Charger
- Footswitch
- Stand
- RS232 Cable and 9 to 25 pin adapter
- Infrared (IrDA) communication adapter
- GSI 70 DMS software installation disks (or CD ROM) and User's Guide

If you believe any items are missing, contact your Grason-Stadler representative.

Precautions

If the Automated OAE is not at room temperature, allow 30 minutes for it to return to operating temperature range before using.



Do not charge the battery (do not place the Screener in the Printer/Charger Module or attach the Screener to the Charging Transformer) at temperatures greater than 113°F (50°C).

Do not store the Automated OAE or Printer/Charger Module at temperatures that exceed 158°F (70°C).

The following is a Key to Screener, Pod and Probe Features Shown on the Next Page:

- 1 Display Screen (Touchscreen in Multi-Patient Models only)
- 2 LEFT Ear memory Button (Blue)
- 3 TEST Button (Green)
- 4 RIGHT Ear Memory Button (Pink)
- 5 Pod Storage Cavity
- 6 Pod (contains probe calibration information)
 - 6A Probe Storage Cavity
 - 6B Start/Stop Button (Green)
 - 6C Yellow LED: Poor Eartip Seal Indicator
 - 6D Green LED: Test Progress Indicator
- 7 Probe (shown with probe tip attached)
- 8 Stylus (in Multi-Patient Models only; for use with Touchscreen)



The stylus has a pointed end. Keep stylus out of reach of infants and small children.

- 9 Access Door for Battery and Language Selector Switches
- 10 Connector for Charging Transformer and Footswitch
- 11 Charging Contacts for Battery
- 12 Infrared Port Window

Automated OAE Screener Features

Use this figure to familiarize yourself with the features of the Screener, Pod, and Probe.

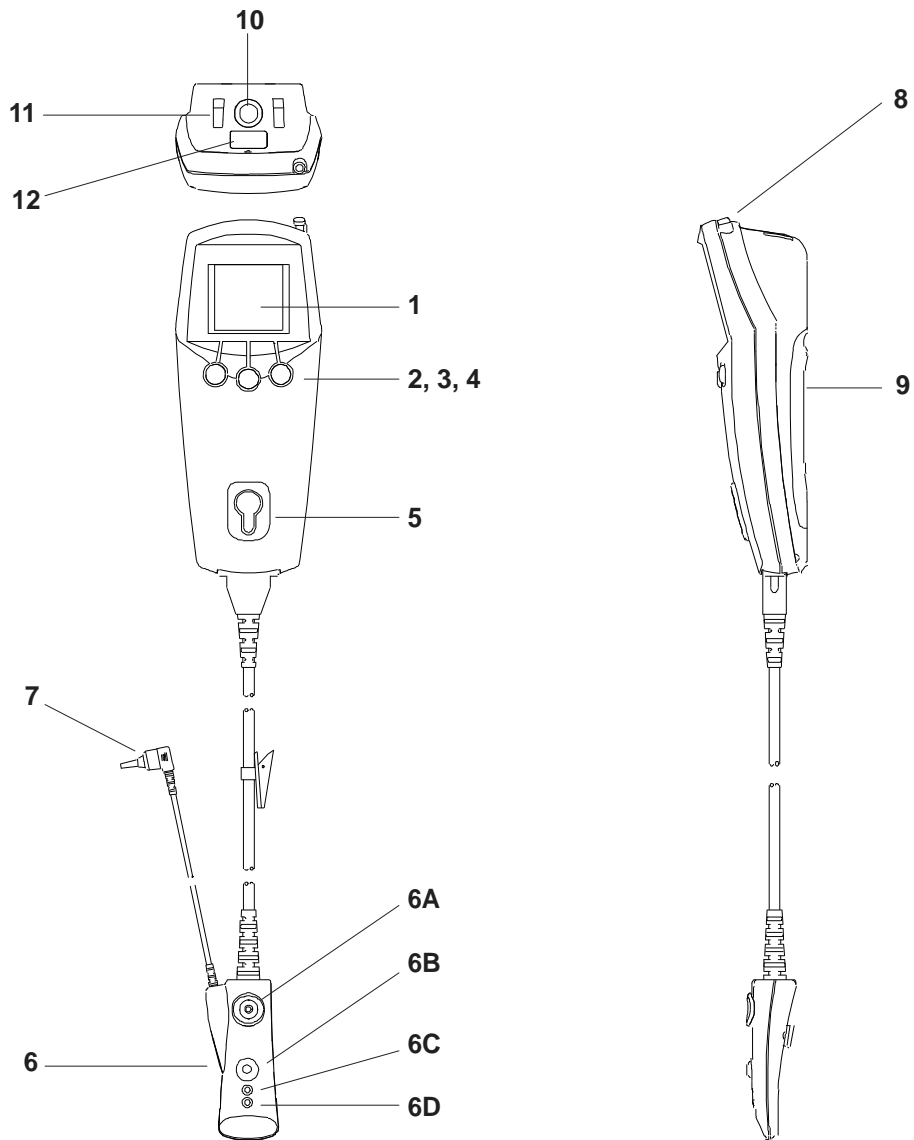



Automated OAE Screener, Pod and Probe Features

Printer/Charger Features

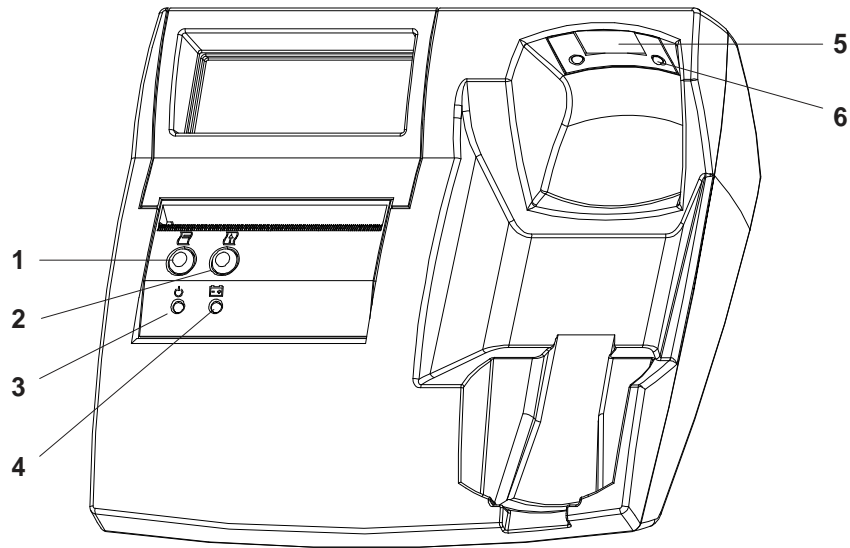
The front and rear illustrations presented below show the features of the Printer/Charger.



Printer/Charger Features (Front)

- 1 Print button 
- 2 Paper Advance button 
- 3 Power / Status LED 
 - Off — Charger not connected to Mains power
 - On — Charger is connected to Mains power
 - Single Flashes — Out of paper
 - Double Flashes — Printer or Charger malfunction

For more information, see *Troubleshooting* on page 69.
- 4 Battery LED 
 - Off — No Screener in Charger
 - On — Screener seated correctly in Charger, and charging
- 5 IrDA port for communication with Screener
- 6 Charging contacts for recharging Screener

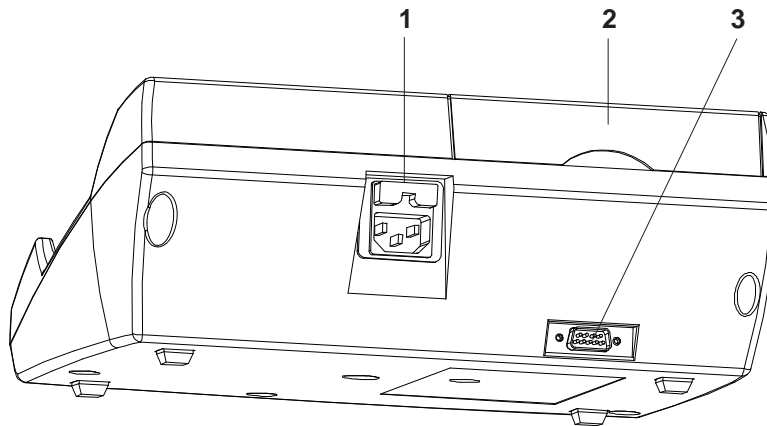

Printer/Charger Features (Rear View)

- 1** Fuse drawer and Mains power connector
- 2** Paper cover
Push here and lift up to open.
- 3** RS-232 connector for attaching the Printer/Charger to a computer (for use with the GSI 70DMS Software only)

Setting Up the Automated OAE Screener

This section covers setting up the Screener for your working environment. Depending on the accessories you purchased and the setting in which you intend to use the Screener, you will need to do one or more of the following:

- Install the battery
- Set the Screener date and time (Multi-Patient model)
- Attach the footswitch to the Screener (Optional)
- Mount the Printer/Charger on the rolling stand (Optional)
- Check the battery
- Adjust the Screener LCD contrast (Optional)
- Install the GSI 70DMS software into your computer (Multi-Patient model)
- Connect the infrared (IrDA) communications adapter to your computer (Optional for the Multi-Patient version of the Screener)

Installing the battery

To install the battery, follow the instructions shown in *Removing or Replacing the Battery* on page 58.

Setting the Screener date and time

The date and time are stored in the Multi-Patient version of the Screener and will be associated with test results. The date and time must be set after the Screener battery is installed. To set the date and time, follow the instructions shown in *Setting the Date and Time* on page 53.

Attaching the Footswitch to the Screener

You can use the footswitch (if purchased) to start and stop tests, enabling you to use both hands to handle an infant or hold the probe tip steady in a premature baby's ear canal.

To attach the footswitch to the Screener:

1. Connect the footswitch to DIN connector on the top of the screener unit.

See *Automated OAE Screener Features* page 7, (#10).

Mounting the Screener or Printer Charger to the optional Rolling Stand

The rolling stand lets you move the Screener, Printer/Charger, a box of eartips, and spare rolls of printer paper easily from patient to patient in a large nursery, or onto an elevator for use in multiple departments.

To mount the Screener to the rolling stand:

1. Slide the screener into the upper bracket.
2. Adjust upper bracket for optimal LCD position by rotating control knob.

To mount the Printer/Charger to the rolling stand:

1. Pull downward on the plate locking mechanism, slide the Printer/Charger mounting plate within the grooves on stand shelf.
2. Release the locking mechanism once the Printer/Charger is fully in place.

Checking the Battery

To check the battery, turn on the GSI 70 Automated OAE by pressing any button.

- If you see a low-battery icon () in the upper-right area of the display, you need to recharge the Screener battery. This icon means you have up to eight minutes in which you can conduct and store about six more tests. The Screener will not allow a test to begin unless there is sufficient battery charge to complete the test. See *Recharging the Battery* on page 59.
- If you do not see the low-battery icon, the Screener battery has sufficient charge.

Adjusting the LCD Contrast

You can adjust the contrast of the LCD to improve the readability of the display or better match the lighting conditions in your work environment.

To adjust the LCD contrast:

1. Press the left (blue) and right (pink) buttons simultaneously.

The Utilities Menu appears.

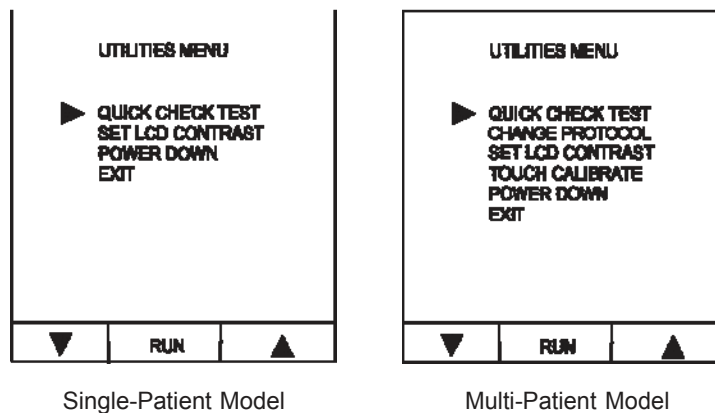

2. Press the down arrow button to move the pointer to the SET LCD CONTRAST OPTION, then press RUN.

The LCD CONTRAST screen appears. The stars are there to help you see the contrast better.

3. Use the up or down arrow buttons to adjust the contrast to your preference, then press EXIT.

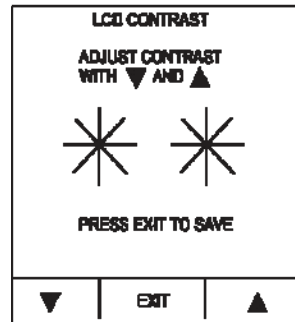

The blank DPGRAM screen appears, and the Single-Patient Screener is ready for testing. For Multi-Patient models, see *Using the GSI 70 Multi-Patient Screener* on page 29.

Installing the GSI 70DMS Software into your Computer

Multi-Patient Screeners require the GSI 70DMS software to communicate with your computer. To install the GSI 70DMS software, follow the instructions provided in the [GSI 70DMS User's Guide](#) that was shipped with the software installation disk set (or CD ROM).

Connecting the Optional Infrared (IrDA) Adapter to a Computer

For Multi-Patient Systems that will use a wireless infrared connection as the interface between the Screener and the computer, connect the optional infrared (IrDA) adapter to one of the computer's COM ports following the instructions that were shipped with the infrared adapter.



Once the GSI 70DMS software is installed on the computer and the infrared (IrDA) adapter is connected, the GSI 70DMS software must be used to configure the COM port to communicate with the Screener. Follow the *COM Port Configuration* instructions provided in the GSI 70DMS User's Guide.

Setting Up the Printer/Charger

For both Single-Patient and Multi-Patient systems, you need to connect the Printer/Charger to Mains power.

If you purchased the Multi-Patient Screener and intend to use the Printer/Charger as the interface between the Screener and a personal computer, you also need to connect the

serial cable from the Printer/Charger to the computer. However, if you plan to use a wireless infrared communication connection between the Screener and computer instead of the Printer/Charger and serial cable, you will need to connect the optional infrared (IrDA) adapter to the computer.

Connecting the Printer/Charger to Mains Power

To set up the Printer/Charger and connect it to Mains power:

1. Place the Printer/Charger on a sturdy, level surface near an electrical outlet. Make sure the Printer/Charger is not near a source of moisture or direct heat.
2. Attach the supplied power cord to the back of the Printer/Charger. See *Printer/Charger Features (Rear View)*, on page 9.
3. Plug the other end of the cord into the electrical outlet for Mains power.
The power/status LED on the Printer/Charger turns on.

If you have a Single-Patient Screener, or a Multi-Patient Screener that will communicate with the computer over an infrared communication connection, the GSI 70 OAE Screener is ready to use.

Connecting the Printer/Charger to a Computer

For Multi-Patient Systems that will use the Printer/Charger as the interface between the Screener and the computer, connect the Printer/Charger to the computer you will use to exchange patient data with the Screener. To connect the Printer/Charger to a computer:

1. Attach the male end of the supplied DB9-pin serial cable to the back of the Printer/Charger. See *Printer/Charger Features (Rear View)*, on page 9. Tighten the thumbscrews on the connector.
2. Locate an available serial port on the back of the computer.
If you are unsure where to connect the cable, consult the documentation that came with your computer.
3. Attach the female end of the cable to the serial port and tighten the thumbscrews.
4. To make sure the computer establishes communications with the Printer/Charger, start the GSI 70 Data Management Software (DMS) and configure the port. See the GSI 70 DMS manual for more information.

The Printer/Charger Module (PCM) is ready to use.

Preparing for a Test



The Screener must be removed from the Printer/Charger cradle before tests can be performed.

Selecting an Eartip

Examine the patient's ear canal then select an eartip that will fit snugly inside the ear canal. Refer to Table 2.

Table 2 – Guide to Eartip Selection

Eartip Size	Fits These Patients (Approximations only)
3 – 5 mm	Newborns
5 – 6 mm	Infants
6 – 9 mm	Young Children
9 – 14 mm	Adults (Age 10 and up)

Attaching an Eartip to the Probe Tip

To attach an eartip to the probe tip:

1. Slide and twist the eartip clockwise onto the probe tip until the eartip is seated snugly against the junction where the probe tip widens (see below).
2. Inspect the end of the probe tip to ensure you can see the ends of all three metal tubes clearly (verify the eartip is not blocking any tubes).

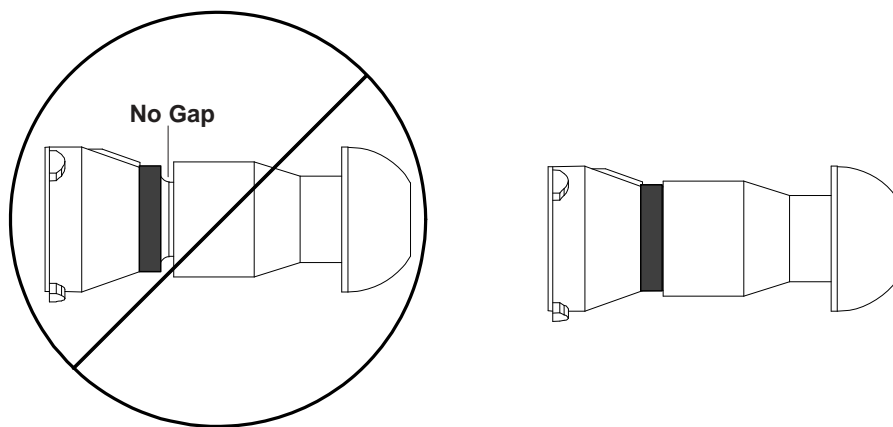

Attaching an Eartip to the Probe Tip

When removing an eartip, twist the eartip clockwise and pull gently. Discard used eartips.



Always attach and remove eartips using a clockwise twisting motion. A counter-clockwise twist may remove the probe tip from the Probe.



KEEP EARTIPS OUT OF REACH OF INFANTS AND YOUNG CHILDREN. EARTIPS MAY BE A CHOKING HAZARD.

Securing the Pod and Probe to the Screener

To make it easy to carry the Screener from patient to patient, you can attach the Pod to the Screener body, and the Probe (without an eartip attached) to the Pod. You can leave the Pod attached to the Screener while running tests.



Remove the eartip before attaching the Probe to the Pod.

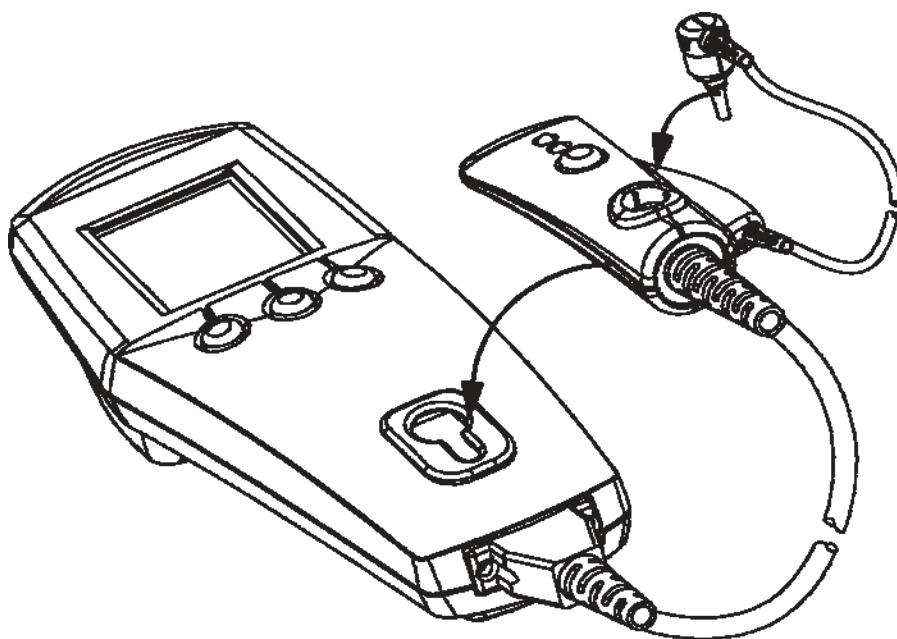

Attaching Probe to Pod, and Pod to Screener

To attach the Pod to the Screener, align the “button” on the under surface of the Pod with the circular opening in the Screener. Press down on the Pod case while sliding the Pod into the keyed opening on the Screener. To remove the Pod, slide it forward and pull it out of the circular opening. Gently insert the Probe into the opening on the Pod until it fits snugly. It is not necessary to force the Probe into a secure position.

Common Displays

This section describes the displays and messages common to the GSI 70 Single-Patient and Multi-Patient Automated OAE Screeners.

Power-Up Display

When you turn on the Screener, it performs a brief self-test.

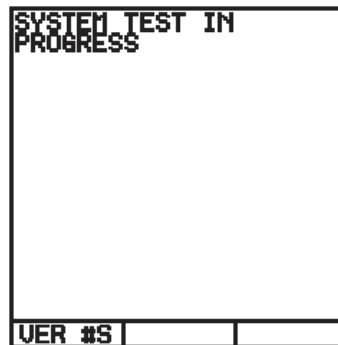

Power-Up Display

Version Information

To see the software and hardware versions of the Screener, press VER #S as soon as or before the Power-Up screen appears. The System Information screen appears, listing the software and hardware versions for all the major components of the Screener.

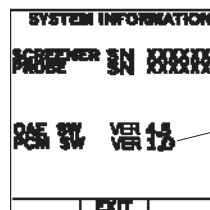

The Printer/Charger (PCM) version is shown only when the Screener is seated in the cradle.

System Information Screen

Press EXIT to continue system initialization.

After the self-test, the GSI 70 Screener briefly displays the message SYSTEM LOADING, and also the date and time for Multi-Patient Screeners. When the Screener is ready to use, a blank DPGRAM appears.

Blank DPGRAM

A DPGRAM is the graphical representation of the patient’s test results. When the Screener is ready to begin testing and the memory is empty, it displays a blank DPGRAM. If test data is present in the Screener memory, the last test stored will be visible on the DPGRAM display.

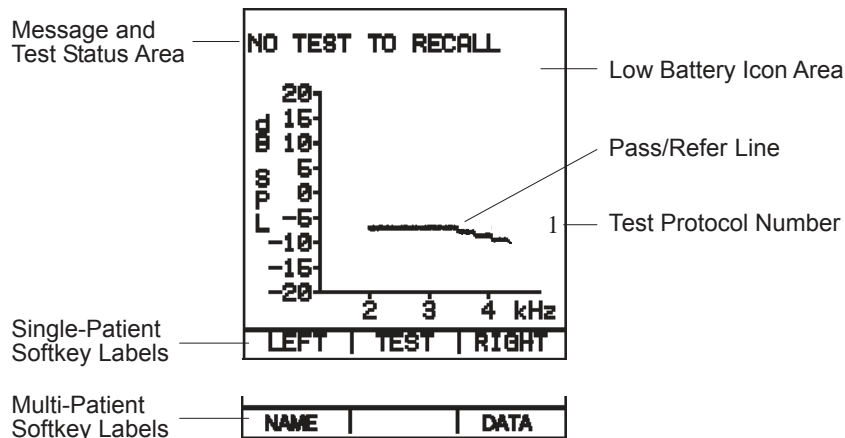

Blank DPGRAM

- Across the top of the display, messages appear about the test and the status of the Screener, such as error conditions.
- In the upper-right area of the display, the low-battery icon appears when the battery level is almost too low to continue testing. See *Recharging the Battery* on page 59. The GSI 70 will not allow testing if the battery charge is too low for valid testing.
- The line across the middle of the graph represents the pass/refer line. See *Reviewing the Test Results* on page 49. The current Test Protocol Number is displayed to the right of the pass/refer line.
- Test response DP amplitudes are shown on the vertical axis of the DPGRAM, and test stimulus frequencies are shown across the horizontal axis. The default OAE test protocol for the Single-Patient and Multi-Patient Screener contains 3 stimulus

frequencies. Additional test protocols can be defined by the user for the Multi-Patient Screener that contain up to 6 stimulus frequencies using the GSI 70DMS software. When more than 3 stimulus frequencies are shown, the presentation of frequencies is reoriented along the horizontal axis to enhance readability.

- The labels across the bottom of the display indicate the function of the buttons directly below them on the Screener. These labels differ between the Single-Patient and Multi-Patient models.

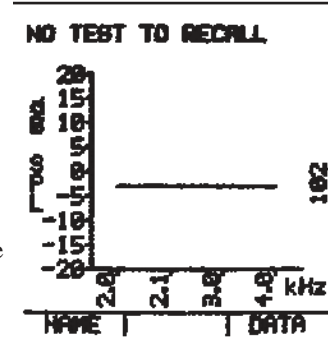

Stimulus Frequencies Reoriented 90 Degrees

Completed DP Gram

As the GSI 70 conducts a test, the display shows the:

- Response from the outer hair cells within the cochlea, called the distortion product or DP
- Averaged noise level within the ear canal, called the noise floor or NF

Before storing the result, the DP is shown as a solid circle and the noise floor is shown as a solid rectangular bar.

When the test is complete, the Screener displays the message OAE TEST COMPLETE and the test result.

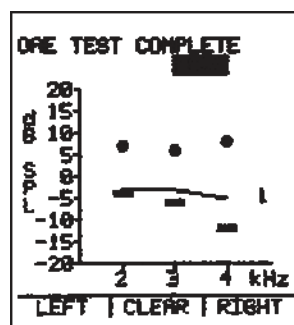

Single-Patient Completed DP Gram
(not yet stored in memory)

Stored DP Gram

When you store a DP Gram, the Screener replaces the message OAE TEST COMPLETE with LEFT ear or RIGHT ear.

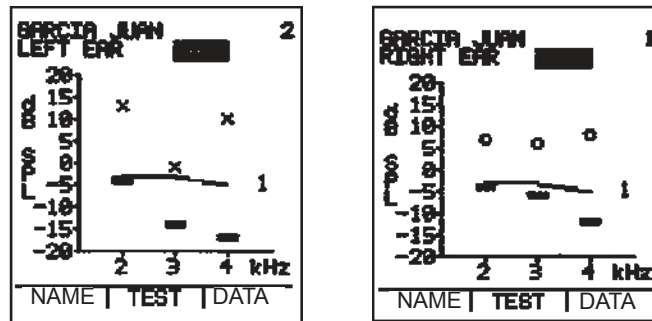

Stored DP Grams: Left and Right

The DPs change from solid circles to standard audiometric symbols, according to which button you pressed:

X	Left ear	— (Blue Button)
O	Right ear	— (Pink Button)

Using the GSI70 Single-Patient Screener 4

This chapter describes the operation of the Single-Patient GSI 70 Automated OAE Screener:

- Daily check of the Screener's performance
- Running a test
- Storing a test
- Printing a test
- Stopping a test
- Retrieving a test
- Erasing a test
- Turning off the Screener

The two LEDs on the Pod indicate the status of the Screener while testing and allow you to monitor the test's progress:

- The green LED flashes while the Screener is checking the eartip's seal in the patient's ear and becomes solid green while the test runs. When the test is complete, the green LED turns off.
- If the Screener detects a problem with the eartip seal, the yellow LED turns on and the green LED turns off.
- If both LEDs are turned on, the Screener is connected to a Printer/Charger or a charging transformer and it is not testing.

Checking the Screener's Performance

Each day, or before each work shift, check the Screener's performance by running the Quick Check test with the included Quick Check Cavity. This test takes about 10 seconds and ensures that the Screener is working properly and that your test results will be reliable.



Run the Quick Check test at least once a day.

See *Running the Quick Check Test* on page 62.

Running a Test

1. Remove the Screener from the Printer/Charger cradle and press any button on the GSI 70 Automated OAE Screener to turn it on.
After a few seconds, the blank DPGRAM will appear if no prior results are stored in memory.



The TEST key will not appear if the battery is too low to run a test or if the Screener is seated in the Printer/Charger cradle.

2. Insert the probe tip with an eartip attached into the patient's ear, seating the eartip well into the ear canal to achieve a tight seal.
3. To start a test, do one of the following:
 - Press the Pod button (green)
 - Press TEST (green) on the Screener



The TEST key only shows if the Screener is not connected to a charging device and the battery is charged enough to finish a test. Otherwise, the test key is not visible and the unit must be charged.

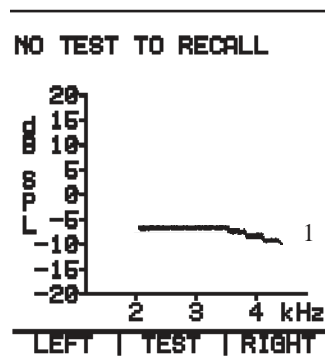

Blank DPGRAM

The Screener displays CHECKING FOR OAE PROBE IN EAR.

If the eartip is not properly sealed in the patient's ear, the Screener does not start a test. After 30 seconds, the Screener stops checking for a seal and displays the message ABORT.

If the eartip seal is good, the Screener displays TESTING OAE. When the test is complete, the Screener displays:

- OAE TEST COMPLETE
- A graph of the test data
- The test result (see *Reviewing the Test Results* on page 49).

The Pod's green LED turns off.

Message CHECK SEAL

If the Screener detects a problem with the eartip seal, the Screener pauses the test, turns the Pod yellow LED on and the green LED off, and displays CHECK SEAL. Reposition the probe tip in the patient's ear, use a different size eartip, or clean the probe tip of debris. See *Cleaning the Probe Tip* on page 57.

When the seal is acceptable, the GSI 70 Automated OAE Screener restarts the test automatically and redisplay TESTING OAE.

If a second seal problem occurs, the GSI 70 Automated OAE Screener stops the test. The display shows:

- OAE TEST COMPLETE
- The data, if any, collected to that point
- The test result ABORT

You can store any data the Screener collected.

Storing a Test

To store a just-completed test:

1. Press the button for the ear you just tested (LEFT - blue or RIGHT - pink).

The Screener stores the data and replaces the message OAE TEST COMPLETE with LEFT EAR or RIGHT EAR.

The Automated OAE Screener stores two results, one test per ear. Each time you press LEFT or RIGHT to store a new test, the Screener overwrites the last test stored for that ear.

Reviewing a Test

To review a stored test:

1. Press LEFT or RIGHT to recall the data for that ear to the screen.

If there is no stored data for the button you pressed, the GSI 70 Automated OAE Screener displays NO TEST TO RECALL.

The data for each ear remains in permanent memory until the next time you store (and thereby overwrite) a test, even when the GSI 70 Automated OAE Screener is off or the battery is removed.

Printing a Test

At any time, you can print the stored tests in the Screener. The Screener sends all the stored data, whether for one or two ears, to the printer. You cannot print data for only one ear if the Screener contains stored data for two ears.

You do not need to retrieve stored test data to print it. To print the stored data:

1. Turn on the Screener.
2. Place the Screener in the Printer/Charger cradle.
3. Press the Printer/Charger's PRINT button.

The Screener displays TRANSFER TO PRINTER. If the transfer is successful, the Screener displays TRANSFER COMPLETE, and the printout begins. If there is no stored data to print, the Printer/Charger prints No Data.

Printing a Test

If you remove the Screener before the printer receives all the data, the message REMOVED TOO SOON appears on the Screener display and the printer.

- To continue testing, wait until the printout begins (about three seconds after you press print) then remove the Screener from the Printer/Charger cradle.

Contents of the Printout

A printout of a single-ear test result is shown below and includes:

- The ear tested (Right, Left or both) and the test result for each test for one or two tests
- The number of the test protocol used to conduct the test
- One or two DPGrams that display the DP (distortion product) points and NF (noise floor) points and the Pass/Refer line
- One or two tables containing the actual numeric values for the patient's DPs and NFs, and the difference between the two points (signal to noise ratio) for each frequency. All DP values at or above 20 dB are shown on the 19 dB line. All NF values at or below -20 dB are shown on the -19 dB line. The table contains the actual distortion product and noise floor values.
- The serial numbers for the Screener and the Probe, and the Protocol used for the test
- Product identification information

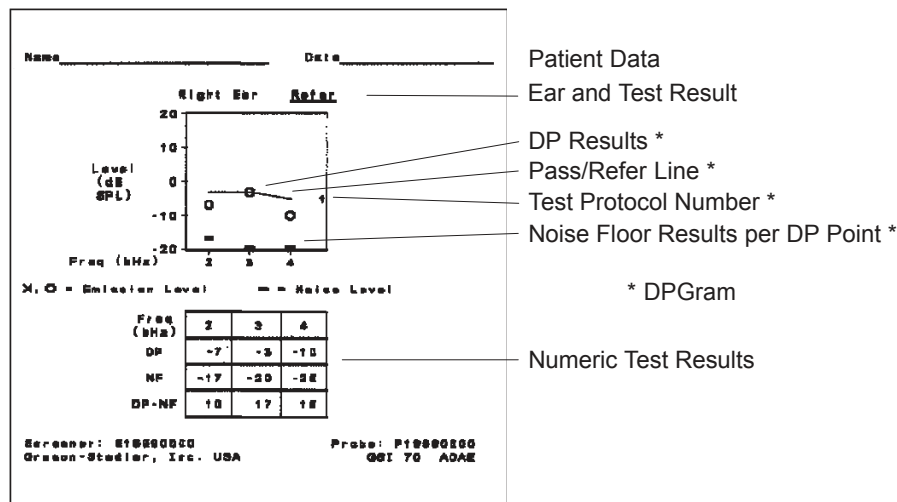

Printout of Test Results for a Single Ear

The double-ear test result printout includes the same information as shown for the single ear on the previous page.

Canceling the Printout

To stop a printout in process, press the PRINT button on the Printer/Charger.

The printer immediately stops printing the test, and prints `Print cancelled` on the next line.

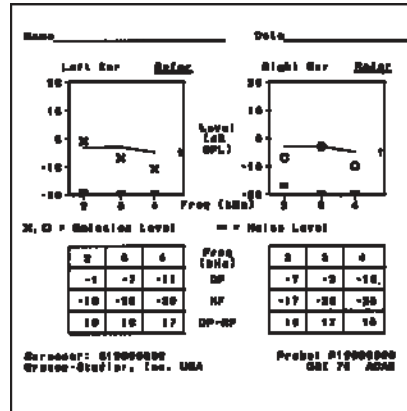

*Printout of Test Results
for Both Ears*

Advancing the Paper

To advance the paper, do one of the following:

- Press the PAPER ADVANCE button. The paper advances by one line.
- Hold down the PAPER ADVANCE button. The paper advances continuously until you release the button.

Stopping a Test

To stop a test in progress:

1. Press the Pod button.

The GSI 70 Automated OAE Screener displays `OAE TEST COMPLETE ABORT` and any data collected to that point.



If you press RIGHT or LEFT after stopping a test in progress, the Screener saves the stopped test and overwrites any previously stored data for that ear.

To start a new test, do one of the following:

- Press the green Pod button
- Press the green TEST button on the Screener

Erasing a Test

There are two ways to erase a test. Either:

- Store a new test for the same ear
This action overwrites the previously stored test in that memory location (RIGHT or LEFT).

- Press and hold LEFT or RIGHT for four seconds and then release the button. The data is cleared and the GSI 70 Automated OAE Screener displays DATA ERASED.

If there is nothing to erase, the GSI 70 Automated OAE Screener displays NO TEST TO ERASE.

Power-Saving Mode

The Screener has a power-saving mode that preserves the battery's charge when you are not running tests. This power-saving mode allows the Screener to preserve the battery charge, yet be ready to continue testing quickly. In this mode, the last screen displayed remains in memory and the display backlighting turns off.

The Screener enters this power-saving mode after 45 seconds of inactivity, as long as the Screener is not either placed in the Printer/Charger Module or connected to the Charging Transformer.

To exit the power-saving mode, press any button. The display lights up and the Screener is immediately ready to use. Any data that was on the screen, including unsaved test data, reappears.



When the Screener is not being used, place it in the (powered) Printer/Charger cradle to increase the battery charge.

Power-Down

You never have to turn off the Screener. The Screener turns itself off completely under the following conditions:

- If the Screener remains idle for two minutes after it enters the power-saving mode
- If the Screener is either placed in the Printer/Charger cradle or connected to the Charging Transformer, it turns off completely after 45 seconds and does not enter the power-saving mode.



When the Screener powers down, it does not retain the information (such as an unsaved test) that was on the display.

- To turn on the Screener, press any button.
- To turn the Screener off immediately, go to the utility menu by pressing the left and right buttons simultaneously, move the selector arrow to POWER DOWN and select. See the Utilities Menu on Page 11.

Low-Battery Icon

When the battery's charge nears the minimum usable level, a low-battery icon () appears on the display. You then have up to eight minutes in which you can conduct and store about six more tests. The GSI 70 Automated OAE Screener will not allow a test to begin unless there is sufficient battery charge to complete the test.

When the battery level falls too low, the GSI 70 Automated OAE Screener turns off. All previously stored test data remains intact. See *Recharging the Battery* on page 59.

Battery Discharge Time

A fully charged new battery will allow the Screener to operate for up to 90 minutes of continuous use without recharging. Placing the Screener in the Printer/Charger for 10 hours will allow the battery to be fully recharged. When testing patients on an intermittent basis the Screener should be placed in the Printer/Charger when not being used as this will allow the battery to recharge between patients. Allowing the battery to recharge between patients will extend the time the Screener can be used before the battery is discharged. This is important as the Screener can not be used for testing if the battery is discharged.

For high volume screening programs it is recommended to purchase an accessory battery charger so that a spare battery can be kept on the charger. If the Screener battery becomes discharged during a test session the spare battery can be installed in the Screener and the discharged battery put on the accessory charger.

Using the GSI70 Multi-Patient Screener 5

The GSI 70 Multi-Patient Screener lets you transfer a list of up to 150 names or identification numbers from a computer running the GSI 70 DMS (Data Management Software) for the patients you need to test. You can also enter patient names or ID numbers with the stylus and the touch screen.

The Screener stores up to 320 tests (a test is the result for one ear). After you run the tests, you can send the data back to the GSI 70 DMS database by either:

- Placing the Screener in the Printer/Charger cradle, thereby using the serial cable for information exchange
- Transmitting data from the Screener to your computer over an infrared (IrDA) connection.

The two LEDs on the Pod indicate the status of the Screener while testing and allow you to monitor the test's progress:

- The green LED flashes while the Screener is checking the eartip's seal in the patient's ear and becomes solid green while the test runs. When the test is complete, the green LED turns off.
- If the Screener detects a problem with the eartip seal, the yellow LED turns on and the green LED turns off.
- If both LEDs are turned on, the Screener is connected to a Printer/Charger or a charging transformer and it is not testing.

This chapter describes the operation of the GSI 70 Multi-Patient Screener:

- Setting up the Screener for testing
- Testing Patients
- Managing the Test Results

For information on using the GSI 70 DMS software, refer to the [GSI 70DMS User's Guide](#) that was shipped with the software.

Setting Up the Screener

To prepare the Screener for testing:

1. Set the Screener's date and time
2. Transfer a list of patients from the computer
3. Select a patient from the list
4. Select a test protocol (if necessary)

Setting the Screener's Date and Time

The date and time are displayed briefly each time the Screener power is turned on, and are included with test results transmitted from the Screener to the GSI 70DMS software. To set the Screener's date and time, follow the instructions provided by *Setting the Date and Time* on page 53.

Transferring a Patient List from the Computer

This section assumes that you have installed the GSI 70 DMS program on your computer and set up either the serial cable or the IrDA port on the computer.

See the GSI 70 DMS manual for the steps to install and start the software and select the patients to test. See *Connecting the Printer/Charger to Mains Power* on page 13 or *Connecting the Optional IrDA Adapter to a Computer* on page 12.

To transfer a list of patients to the Screener:

1. Start the GSI 70 DMS, select the Transfer Names tab, and select up to 150 names to transfer. Click the Transfer Names button to begin the transfer process (see the [GSI 70 DMS User's Guide](#) for details).
2. Press any button to turn on the Screener.

The Screener performs a brief self-test, displays the current date and time and then displays one of the following screens depending on its state the last time someone used the Screener:

 - Last test stored
 - Blank DPGram if the patient database is empty
3. Press the NAME (blue) button on the screener.

The SELECT PATIENT NAME screen appears.
4. Do one of the following:
 - Place the Screener in the (powered) Printer/Charger cradle for transfer via the serial

cable.

- Point the Screener infrared (IrDA) lens toward the lens on the infrared communication adapter attached to your computer (if purchased).

5. Press LOAD.

The POSITION FOR LOAD screen appears. When the computer begins to automatically transfer the selected patients to the Screener, the Screener message LOADING appears. When complete, the Screener displays LOAD COMPLETE, then returns to the SELECT PATIENT NAME screen which shows the new list of patients.

Entering Patient Names or ID Numbers from the Screener

The GSI 70 Multi-Patient Screener lets you enter a patient name or ID number as you work. Use this feature when you need to test a patient whose name or ID is not in the GSI 70 DMS database. This feature allows you to test a patient whose name was not transferred from the GSI 70 DMS program to the Screener. Entering a patient name in this manner adds the name to the patient list in the screener.



All names in the Screener's current patient list will be erased when a new list of names is transferred from the GSI 70DMS program.



Entering patient names and ID's using the touchscreen while the Screener is out of the Printer/Charger's cradle will use some of the Screener battery's charge. Less charge will be used when the screener is in the Printer/Charger cradle while entering the names. It is best to enter the names and ID's into the GSI 70DMS Software and then transfer them to the Screener.

To enter a patient name or ID number:

1. Press any softkey to wake up the Screener.

The Screener performs a brief self-test, displays the current date and time and then displays one of the following screens depending on its state the last time someone used the Screener:

- Last test stored
- Blank DPGRAM if the patient database is empty

2. Press the NAME (blue) button on the Screener.

The SELECT PATIENT NAME screen appears.

3. Press KEYBD.

The ENTER PATIENT NAME/ID screen appears.

4. Use the stylus (stored in the body of the Screener) to enter up to 19 characters for the patient's name or ID number. The characters can be any combination of numbers, letters, punctuation marks, and spaces, but you cannot begin a name or ID with a space.

- To enter a character, touch the character with the stylus.
- To enter a space, press space. The cursor moves forward one space.
- If you make a mistake, press erase to back up and erase the previous character, then enter the correct character. You can back up to the beginning and start over.

5. Press SELECT.

The Screener displays a blank DPGram, with the name or ID number you just entered across the top. The Screener is ready to test this patient.



All the tests you run are associated with this patient until you select another name or ID number.

Selecting a Patient from the List

Once you transfer a list of patient names or ID numbers from the GSI 70 DMS, you can select the patient to test from the SELECT PATIENT NAME screen as you work. When you select a patient, all the tests you run are associated with that patient until you select another name or ID number.

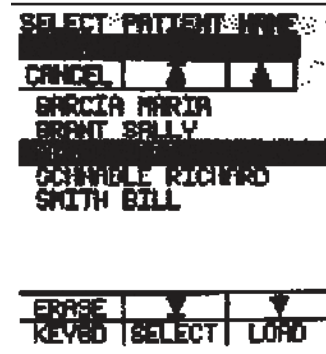

Select Patient Name Screen

Names you enter manually from the touchscreen and names that come from the computer remain in the PATIENT list until the next time names are transferred from the GSI 70 DMS software. You can reselect a name that you have already tested for further testing. Up to nine tests can be stored per patient.

To select a patient to test:

1. Press the NAME (blue) button on the Screener.
2. From the SELECT PATIENT NAME screen, use the stylus to scroll through the list of patients:
 - Touch ▼ to page down one screen, and ▲ to page up one screen
 - Touch ▾ to go to the end of the list, and ▲ to go to the beginning of the list

To search for a patient:

1. Press KEYBD.
 - The ENTER PATIENT NAME/ID screen appears.
2. Enter the first few characters of the patient's name or ID number, and then touch SEARCH.
 - The SELECT PATIENT NAME screen reappears, and the first name/ID matching those characters appears highlighted at the top of the list.
3. Touch the patient name or ID number you want to test, and then press SELECT.
 - The Screener displays a blank DPGram and the patient's name or ID number. The Screener is ready to test this patient.

Erasing a Patient Name from the List

Names entered from the touchscreen or loaded from the computer can be erased at any time from the SELECT PATIENT NAME screen. To erase a name:

1. Select the Patient name as described earlier in this section.
2. Touch ERASE . You will be asked to confirm your intention to erase the name. Touch YES to erase the name. The name will be erased, but the test data are still stored.

Selecting a Test Protocol

The number of the test protocol currently selected for scoring test results is shown on the right side of the DPGram screen.

The Single-Patient Screener uses only one protocol, but the Multi-Patient Screener can store up to 5 different OAE test protocols. These protocols can be defined by the user and transferred to the Screener using the GSI 70DMS software. Test protocols contain up to 6 stimulus frequencies and are selected from the Utilities Menu. Test protocol number 1 is the default protocol. Other factory-installed protocols are assigned numbers from 2 to 99, and user-defined protocols are assigned numbers 100 and higher.

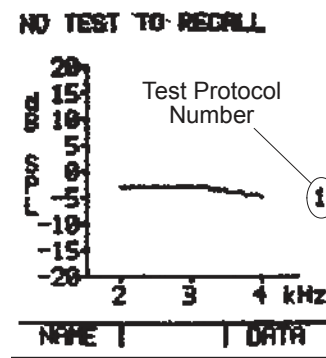

To change the current test protocol:

1. Press the LEFT (blue) and RIGHT (pink) Screener buttons to display the Utilities Menu.
2. Scroll down to CHANGE PROTOCOL and press RUN. The SELECT PROTOCOL screen is displayed.
3. Use the stylus to select the desired test protocol and press SELECT. The protocol will be selected and the Utilities Menu will be displayed again.
4. Scroll down to EXIT on the Utilities Menu and press RUN.

The new protocol is ready to be used for testing.

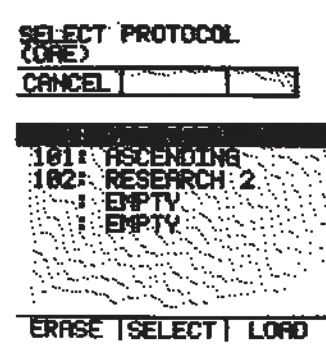

Transferring a New Test Protocol from the Computer

This section assumes that you have installed the GSI 70 DMS program on your computer and set up either the serial cable or the IrDA port on the computer.

See the [GSI 70 DMS User's Guide](#) for the steps to install and start the software and select the protocol to transfer. See *Connecting the Printer/Charger to Mains Power* on page 13 or *Connecting the Optional IrDA Adapter to a Computer* on page 12.

To transfer a protocol to the Screener:

1. Start the GSI 70 DMS, select the Transfer Protocol command of the Screener menu, enter your password and select the protocol to be transferred (see the [GSI 70 DMS User's Guide](#) for details).
2. Press any Screener button to turn on the Screener.
The Screener performs a brief self-test, displays the current date and time and then displays one of the following screens depending on its state the last time someone used the Screener:
 - Last test stored
 - Blank DPGram if the patient database is empty
3. Press the RIGHT and LEFT Screener buttons simultaneously to display the UTILITIES MENU.
The UTILITIES MENU screen appears.
4. Scroll to CHANGE PROTOCOL and touch RUN.
The SELECT PROTOCOL screen appears.
5. Select an EMPTY location and press LOAD.
The new protocol will be transferred to the Screener and will appear in the list of protocols on the SELECT PROTOCOL screen.



A maximum of 5 protocols can be stored in the Screener. Location #1 is reserved for the factory default protocol.

Deleting a Test Protocol from the Screener

Test protocols can be deleted from the Screener at any time to make room for new protocols or remove unnecessary or obsolete protocols. To delete a test protocol:

1. Press the RIGHT and LEFT Screener buttons simultaneously to display the

UTILITIES MENU.

The UTILITIES MENU screen appears.

2. Scroll to CHANGE PROTOCOL and touch RUN.

The SELECT PROTOCOL screen appears.

3. Select the protocol that you wish to remove from the Screener.



Confirm that the protocol selected is actually the one you wish to remove.

4. Press ERASE to remove the highlighted protocol.

You will be asked to confirm your intention to erase the highlighted protocol. Touch YES to complete the delete operation.

The highlighted protocol will be removed from the Screener's memory and from the SELECT PROTOCOL screen. The factory default protocol in location #1 cannot be erased.

Testing Patients

This section assumes that you have set the date and time, selected a new test protocol if necessary, and either:

- Transferred a list of patients from the GSI 70 DMS and selected one of them to test, OR
- Entered a new patient name or ID number from the Screener touchscreen via the keyboard.



Until you select a name or ID number, the Multi-Patient Screener cannot run a test. When you select a patient, a blank DPGRAM appears with that patient's name or ID number across the top.



The TEST key only shows up when the Screener is not connected to a charging device and the battery has enough charge to finish a test. Otherwise, the TEST key will disappear preventing the test from being started.

Running a Test

To run a test:

1. Select and attach an appropriate size eartip to the probe tip.
2. Insert the probe tip into the patient's ear, seating it well into the ear canal to achieve a tight seal.
3. Do one of the following:
 - Press the green button on the Pod
 - Press TEST (green button) on the Screener
 - Press the footswitch

The Screener displays CHECKING FOR OAE PROBE IN EAR, and the Pod's green LED flashes. If the eartip seal is good, the Screener displays TESTING OAE and the Pod's green LED stays on continuously. If the eartip does not properly seal the patient's ear, the Screener does not start a test. After 30 seconds, the Screener stops checking for a seal and displays the message ABORT. When the test is complete, the Screener displays:

- OAE TEST COMPLETE
- A graph of the test data

- The test result (see *Reviewing the Test Results* on page 49).

The Pod's green LED turns off.

Message CHECK SEAL

If the Screener detects a problem with the eartip seal, the Screener pauses the test, turns the Pod yellow LED on and the green LED off, and displays CHECK SEAL. Reposition the probe tip in the patient's ear, use a different size eartip, or clean the probe tip of debris. See *Cleaning the Probe Tip* on page 57.

When the seal is acceptable, the Screener restarts the test automatically and re-displays TESTING OAE. If a second seal problem occurs, the Screener stops the test. The Screener displays the message ABORT.

Stopping a Test

To stop a test in progress:

- Press the green Pod button.

The GSI 70 Automated OAE Screener displays OAE TEST COMPLETE ABORT and also displays data collected to that point.



To erase the aborted test, press the CLEAR (green) button on the Screener.

Storing a Test

To store a completed test:

- Press the button for the ear you just tested (LEFT - blue or RIGHT - pink).

The Screener stores the data and replaces the message OAE TEST COMPLETE with left ear or right ear. The Screener assigns each test a sequence number from 1 to 9, and displays this number to the right of the patient's name or ID number.

If the Screener contains nine tests for the same patient and you try to run another test, the Screener displays the message TEST SEQUENCE FULL. You can erase and reuse test sequence numbers. See *Erasing a Test* on page 41.

Managing the Test Results

The GSI 70 Multi-Patient Screener lets you:

- Review the tests by patient and sequence number
- Download test results to the GSI 70 DMS program on a computer
- Erase test results from the Screener memory

Sending Test Results to the GSI 70 DMS

You can select which test results you want to download to the computer, either by patient or by category.

There are two numbers on the top line of the DATA screen. The first number, which appears highlighted, represents the number of tests selected. The second number represents the total number of tests in the Screener's test database. In addition, the test category or the patient name also appears highlighted in the list area.

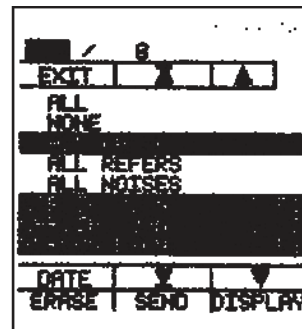

Data Screen

The GSI 70 DMS compares the patient names or ID numbers to the information in its database to determine whether it already contains data for a patient. If it does, the program then compares the time and date stamp and the data for the test(s) being sent to the test(s) in its database. If the time and date stamp along with all DP and NF values are identical, the GSI 70 DMS disregards the duplicate test record.

This feature prevents two testers from sending the same data to the computer and filling up the database with duplicate records.

To download test results to the computer:

1. In the GSI 70 DMS, select the COLLECT RESULTS tab. Click on the Collect Results Button. See the GSI 70 DMS manual for details.
2. On the Screener, display the DATA screen by doing one of the following:
 - If the Screener shows a DPGram, press DATA
 - If the Screener is in display mode, press EXITThe DATA screen appears.

3. Select the tests you want to send to the computer by doing one of the following:

- To select all tests, touch ALL with the stylus.
- To select ALL PASSES, ALL REFERS, or ALL NOISES, touch the test category with the stylus.
- To select the results for one or more patients, touch the tests you want to send. Once selected, the name/result is highlighted.
- To select both a test category and individual tests from the list, touch the test category and then touch the additional tests you want to review. (With this option, the test category name becomes unhighlighted, but the tests within that category, and all additional tests you select, remain highlighted.)

4. Do one of the following:

- Point the Screener toward the IrDA adapter on the computer. The Screener can be up to three feet (or 1 meter) from the IrDA adapter.
- Place the Screener in the powered Printer/Charger Module (PCM).



Typically, it takes up to 50 seconds to transfer a full database of 320 tests to the computer. You may want to place the Screener in the Printer/Charger Module (PCM) or put the Screener on a flat surface pointing towards the IrDA port while transferring large numbers of test results.

5. On the Screener, press the SEND (green) button.

The words POSITION FOR TRANSFER appear at the top of the display. When the Screener begins to automatically download the selected tests to the computer, the TRANSFERRING message appears.

Hold the Screener steady or leave it in the Printer/Charger until the message TRANSFER COMPLETE appears. See the GSI 70 DMS manual for information on working with the transferred test results.

Erasing a Test

At any time, you can erase tests from the Screener. For instance, after you download test results to the computer, you can erase those results from the Screener's memory to provide space for additional tests.

A patient's test sequence numbers represent the order in which the tests were performed. The Screener does not allow a test with a low sequence number to occur after a test with a higher sequence number provided the date and time have not been changed between tests.

You can erase any number of tests for a specific patient. However, if you want to retest that patient and reuse certain test sequence numbers, you must erase all the tests for that patient back to the number you want to reuse.

You cannot reuse sequence number 3 if the Screener contains numbers 4 and 5. The next test you run for this patient will be number 6. The Screener does not renumber the tests to fill in any missing numbers.

To erase test results from the Screener's memory:

1. Display the DATA screen by doing one of the following:
 - If the Screener shows a DP Gram, press DATA
 - If the Screener is in display mode, press EXITThe DATA screen appears (see page 39).
2. Select the tests you want to erase by doing one of the following:
 - To select all tests, touch ALL with the stylus
 - To select ALL PASSES, ALL REFERS, or ALL NOISES, touch the category name with the stylus
 - To select the results for one or more patients, touch the tests you want to erase
 - To select both a test category and individual tests from the list, touch the test category and then touch the additional tests you want to review. (With this option, the test category name becomes unhighlighted, but the tests within that category, and all additional tests you select, remain highlighted.)

As you select a category or individual tests, the highlighted number at the top of the display shows the number of tests currently selected.

3. Press ERASE.

The Screener displays a confirmation message ERASE DATA?. Do one of the following:

- Press YES to proceed. The Screener erases the selected tests and returns to the data screen.
- Press NO to cancel the erase request and return to the DATA screen.

The second number at the top of the DATA screen decreases by the number of tests erased, and shows the new total number of tests in the list. The first number in the list becomes zero.

Reviewing a Test

You can look at the test results for any patient or group of patients, or any result category. For example, you can look at all the patients you tested today, or all the tests with a REFER result. For more information on the test result definitions, see *Reviewing the Test Results* on page 49.

The test data remains in permanent memory even when the Screener is off or the battery is removed until it is erased.

To review a test:

1. Display the DATA screen by doing one of the following:

- If the Screener shows a DPGRAM, press DATA
- If the Screener is in display mode, press EXIT

The DATA screen appears.

2. Select the tests you want to review by doing one of the following:

- To select all tests, touch ALL with the stylus
- To select ALL PASSES, ALL REFERS, or ALL NOISES, touch the test category with the stylus
- To select tests for one or more patients, touch the tests you want to review
- To select both a test category and individual tests from the list, touch the test category and then touch the additional tests you want to review. (With this option, the test category name becomes unhighlighted, but the tests within that category, and all additional tests you select, remain highlighted.)

3. Touch DISPLAY.

The Screener displays the DPGram for the first test you selected. The patient's name or ID number and the test sequence number appear on the first line, and the ear tested and result appear on the next line.

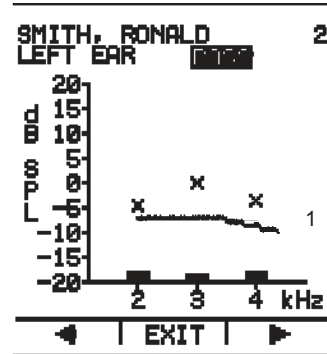

In display mode, the left (blue) and right (pink) buttons on the Screener are marked with left and right arrows, allowing you to scroll through the selected tests.

4. Press ► to display the next test, and ◀ to display the previous test.

- If you selected ALL, the Screener displays the next test in sequence each time you press ► until it reaches the end of the database, then the Screener displays the first test again.
- If you selected a test category or several tests from the list, the Screener displays the next test in the selected sequence each time you press ► until you reach the end of the selected tests, then the Screener displays the first test again.

5. Press EXIT to return to the DATA screen.

Printing a Test

At any time, you can print the stored tests in the Screener. There are three ways to select and print tests:

- After running and storing a test, print all the tests for that patient
- Print all tests in a result category
- Select specific tests to print

For each patient, the Screener automatically pairs the test results for the left ear with those for the right ear. For example, if you ran four left ear tests and four right ear tests in any order, the Screener pairs the first left with the first right, and prints them on the same report. Then it pairs the second left with the second right, and so on.

If there is an unpaired test left over, the Screener prints it on its own report.

When the Screener begins sending the information to the Printer/Charger, it displays the message TRANSFER TO PRINTER. If the transfer is successful, the Screener displays TRANSFER COMPLETE, and the printout begins, except:

- If there is nothing to print, the Printer/Charger prints No Data.
- If you remove the Screener before the Printer/Charger receives all the data, the message REMOVED TOO SOON appears on both the Screener display and the printout.
- If the Screener is not properly placed in the Printer/Charger cradle, the Printer/Charger prints No Screener.

Printing All Tests for a Patient

The Screener provides a quick way to print all the tests for a patient, right after you run a test.

To print all tests for a patient:

1. Run and store a test. Leave the completed DPGRAM on the display.
2. Place the Screener in the (powered) Printer/Charger cradle.
3. Press the PRINT button on the Printer/Charger.

The Screener downloads all the stored tests for this patient to the Printer/Charger, and automatically pairs the results. If this is the first test for this patient, the printout contains only this test.

Printing Selected Tests

To print tests in a certain category or for several patients:

1. Display the DATA screen by doing one of the following:
 - If the Screener shows a DPGRAM, press DATA
 - If the Screener is in display mode, press EXIT
2. Select the tests you want to print by doing one of the following:
 - To select all tests, touch ALL with the stylus
 - To select ALL PASSES, ALL REFERS, or ALL NOISES, touch the category name with the stylus
 - To select tests for one or more patients, touch the tests you want to print
 - To select both a test category and individual tests from the list, touch the test category and then touch the additional tests you want to review. (With this option, the test category name becomes unhighlighted, but the tests within that category, and all

additional tests you select, remain highlighted).

3. Place the Screener in the (powered) Printer/Charger cradle.
4. Press PRINT.

The Screener downloads all the selected tests to the PCM, and automatically pairs the results for each patient. If there is only one test for a patient, that test appears on its own printout.

Printing Individual Test Results

If you are reviewing test results on the Screener display, you can print them individually. To print tests from the display:

1. In the DATA screen, select one or more tests to display. See *Reviewing Test Results* on page 49.
2. Press DISPLAY.

The Screener displays the DPGRAM for the first test you selected.

3. Place the Screener in the (powered) Printer/Charger cradle.
4. Press PRINT.

The Printer/Charger prints the displayed test.

5. To print additional tests, press  to display the test you wish to print, and then press PRINT.

The Screener prints tests one by one from the DISPLAY screen. Even if you selected multiple tests for the same patient, the Screener does not automatically pair the results when you print them from this screen.

Contents of the Printout

The printout includes:

- The patient's name or ID number and the date and time tested
- The ear tested (Right, Left or both), the test results, and the test sequence number
- One or two DPGRAMs that display the DP (distortion product) points, NF (noise floor) points, Pass/Refer line (optional) and test protocol number
- One or two tables containing the actual numeric values for the patient's DPs and NFs, and the difference between the two points for each frequency

All DP values at or above 20 dB are shown on the 19 dB line, and all NF values at or below -20 dB are shown on the -19 dB line. The table contains the actual distortion

product and noise floor values.

- The serial numbers for the Screener and the probe
- Product identification information

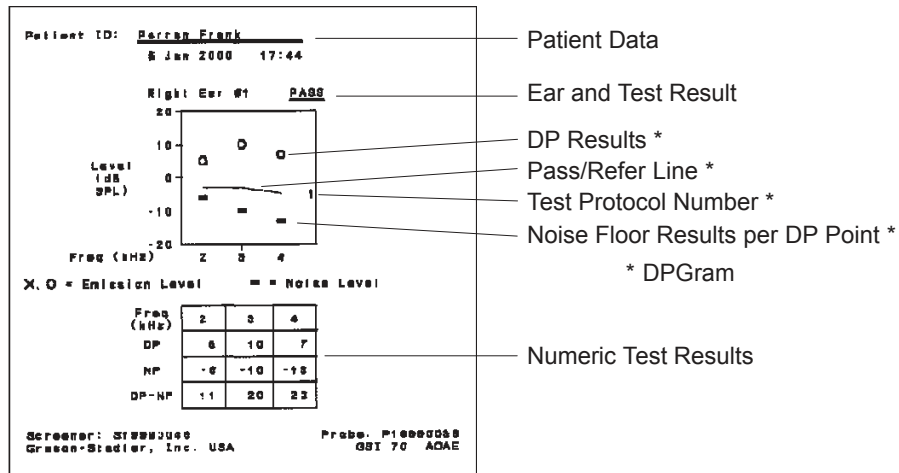

Printout of Test Results for a Single Ear

Printouts of test results for both ears contain the same information as those for single ears. DPGram frequencies for test protocols containing more than 3 stimulus frequencies are reoriented 90 degrees along the horizontal axis.

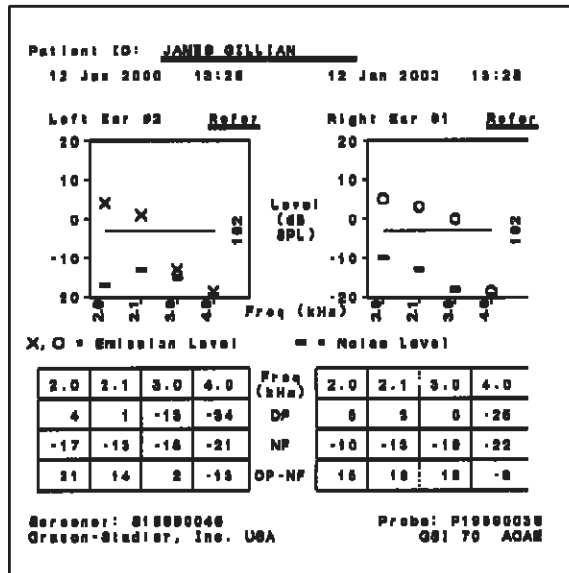

Printout of Test Results for Both Ears

Canceling the Printout

To stop a printout in process:

- Press PRINT.

The printer immediately stops printing the test, and prints `Print cancelled` on the next line.

Advancing the Paper

To advance the paper, do one of the following:

- Press PAPER ADVANCE. The paper advances by one line.
- Hold down PAPER ADVANCE. The paper advances continuously until you release the button.

Power-Saving Mode

The Screener has a power-saving mode that preserves the battery's charge when you are not running tests. This power-saving mode allows the Screener to preserve the battery charge, yet be ready to continue testing quickly. The Screener enters this power-saving mode after 45 seconds of inactivity, as long as the Screener is not either placed in the Printer/Charger cradle or connected to the Charging Transformer. In this mode, the last screen displayed remains in memory and the display backlighting turns off.

To exit the power-saving mode, press any button or touch the LCD. The display lights up and the Screener is immediately ready to use. Any data that was on the screen, including unsaved test data, reappears.



When the Screener is not being used, place it in the (powered) Printer/Charger cradle to increase the battery charge.

Power-Down

You never have to turn off the Screener. The Screener turns itself off completely under the following conditions:

- If the Screener remains idle for two minutes after it enters the power-saving mode
- If the Screener is either placed in the Printer/Charger cradle or connected to the Charging Transformer, it turns off completely after 45 seconds and does not enter the

power-saving mode.

- If you want to turn the Screener off immediately, use the UTILITY MENU by pressing the LEFT and RIGHT keys simultaneously and run the POWER-DOWN procedure.

In these cases, the Screener does not retain the information (such as an unsaved test) that was on the display.

- To turn on the Screener, press any button.
- To turn the Screener off immediately, use the UTILITY MENU by pressing the LEFT and RIGHT keys simultaneously and run the POWER-DOWN procedure.

Low Battery Icon

When the battery's charge nears the minimum usable level, a low battery icon () appears on the display. You then have up to eight minutes in which you can conduct and store about six more tests. The GSI 70 Automated OAE Screener will not allow a test to begin unless there is sufficient battery charge to complete the test.

When the battery level falls too low, the GSI 70 Automated OAE Screener turns off. All previously stored test data remains intact, but a test in progress at the time is lost. See *Recharging the Battery* on page 57.

Battery Discharge Time

A fully charged new battery will allow the Screener to operate for up to 90 minutes of continuous use without recharging. Placing the Screener in the printer charger for 10 hours will allow the battery to be fully recharged. When testing patients on an intermittent basis the Screener should be placed in the printer charger when not being used as this will allow the battery to recharge between patients. Allowing the battery to recharge between patients will extend the time the Screener can be used before the battery is discharged. This is important as the Screener can not be used for testing if the battery is discharged.

For high volume screening programs it is recommended to purchase an accessory battery charger so that a spare battery can be kept on the charger. If the Screener battery becomes discharged during a test session the spare battery can be installed in the Screener and the discharged battery put on the accessory charger.

Test Result PASS

A screening result of PASS means that at the time of testing, the cochlea responded well to the tones presented through the probe. Each OAE response is above the PASS/REFER line, and the noise level at each frequency tested is at least 10 dB below the corresponding OAE response.

An X (left ear) or an O (right ear) is used to represent the OAE response. The thin line, which runs horizontally from 2k to 4k Hz, represents the PASS/REFER line. The solid dashes represent the intensity of the noise present within the ear canal during each OAE measurement at 2k, 3k, and 4k Hz.

The example Multi-Patient printout below for PASS indicates that the intensity of the OAE responses at 2k, 3k, and 4k Hz are 5 dB, 10 dB, and 7 dB, respectively. The noise floor measured at each OAE frequency is at or below -6 dB. As a result, this example shows a very large separation between the OAE (O) and the noise floor (—). The values for this separation (signal-to-noise) are extremely good at 11 dB (2k), 20 dB (3k), and 20 dB (4k), respectively. The GSI 70 Automated OAE Screener scores the test result as a PASS when the OAE responses are above the PASS/REFER line and the signal-to-noise is at least 10 dB.

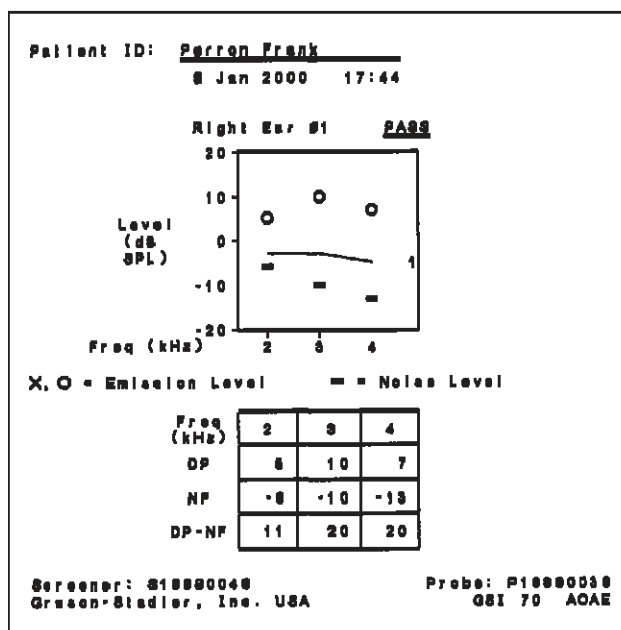

Test Result REFER

An OAE screening scored as REFER indicates that both the OAE response and the noise floor at each test frequency are very low.

In this example, the OAE response at 2k, 3k, and 4k Hz are 1 dB, 2 dB, and -15 dB, respectively. The noise floor at each frequency is sufficiently low to allow the GSI 70 Automated OAE Screener to reliably measure for an OAE response. The OAE response is also very low in intensity at 4k Hz. When a REFER result is obtained, it is recommended that the test be run a second time to see if it is repeatable. If the result is repeatable, there are at least three possible explanations:

- The cochlea is not responding well to the tones being presented due to some problem at the outer hair cells.
- There is fluid present within the middle-ear space that is preventing the stimulating tones from reaching the cochlea at a high enough intensity to activate the OAE response.
- The ear canal and/or the probe tip are plugged with vernix or debris that is preventing the tones from traveling through the middle ear to the cochlea. Thus, the outer hair cells are not being activated properly.

It is highly recommended that the screening session be repeated once again prior to discharge, as the possible conditions described above may be resolved over time.

If the results are not repeatable, check the probe tip for debris and re-check the ear canal for size and shape. Clean the probe tip with the cleaning wires or select a different size ear tip before repeating the test once again.

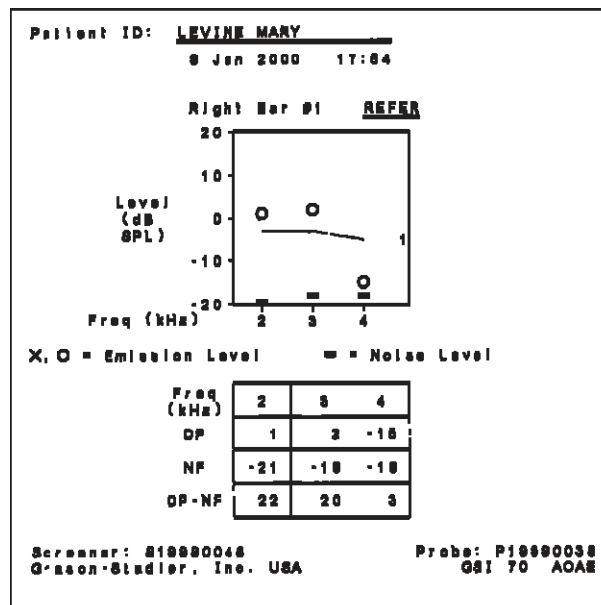

Test Result NOISE

A response is scored as NOISE when there is either too much biological or room noise present while performing the test. This noise prevents the GSI 70 from being able to accurately measure the presence of an OAE response.

The example shows that the noise floor at the OAE frequency of 2k Hz is at 0 dB. When the noise floor is high, it is very difficult to obtain a 10 dB separation between the OAE response and the noise floor. In the current example, the signal-to-noise is -1 dB (2k), 11 dB (3k), and 10 dB (4k). The separation between the OAE response and the noise floor is too small at 2k Hz to reliably score the test result as a PASS or REFER. The score of NOISE indicates that either room noise or the baby's biological sounds are interfering with data collection, the ear canal is collapsed, or the ear tip fit is poor.

You can store any data the Screener collected.

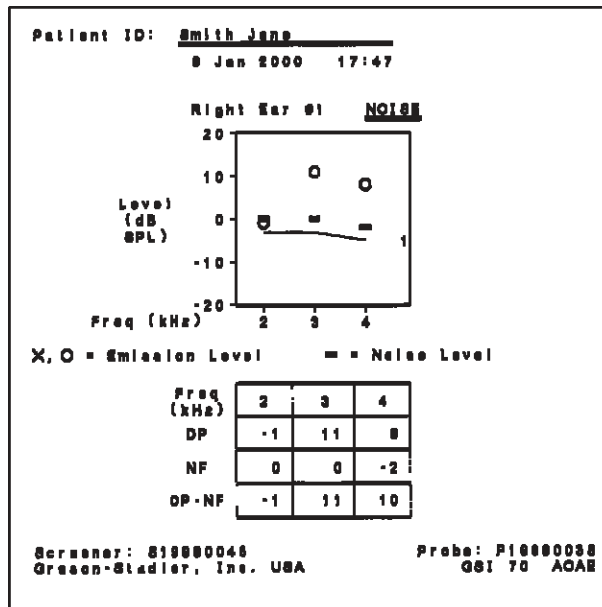

Test Result ABORT

The result ABORT means either:

- You stopped a test by pressing the green Pod button.
- The Screener detected that the eartip was not making a good seal in the patient's ear and stopped running a test.

In both cases, if you see a stored test with the result ABORT, it means you saved the test. There may be no data points or only one or two. Any data points are valid, since the Screener stops collecting data when the eartip's seal in the ear is broken. However, you should run a new test, since the result ABORT does not indicate the test status as a PASS or a REFER.

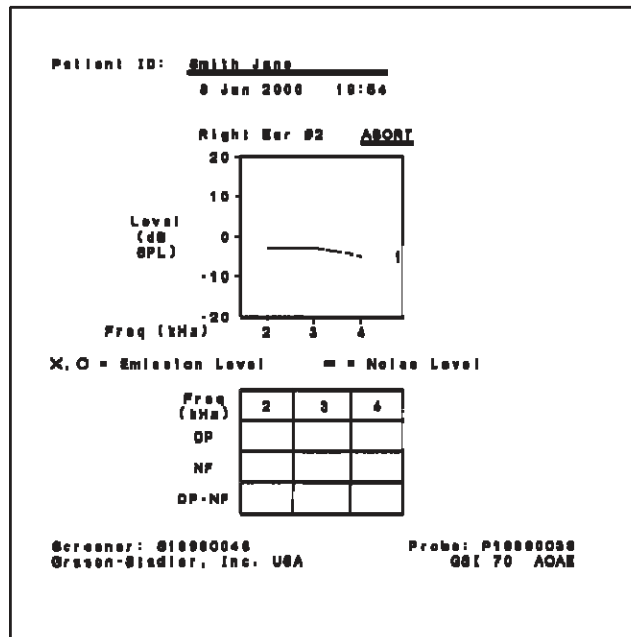

This section describes the basic procedures to maintain your system:

- Cleaning the Screener, Printer/Charger, and probe tip
- Recharging the battery
- Checking the Screener with the Quick Check Cavity
- Calibrating the Touchscreen
- Checking the Printer/Charger by printing a test pattern

Setting the Date and Time (GSI 70 Multi-Patient Screener Only)

You can set the date and time in the GSI 70 Multi-Patient Screener so that test results you print or send to the computer will contain a date and time record. There are two ways to set the date and time:

- Enter the date and time on the touchscreen
- Transfer the date and time settings from the computer running the GSI 70 DMS to the Screener

If you remove the battery from the Screener, such as when you replace a discharged battery with a new one, you must reset the date and time if the unit is without a battery for more than five minutes. When you turn the Screener on after changing the battery, the SET DATE AND TIME screen appears automatically during system initialization.



Date and time are preserved for approximately five minutes after battery is removed.

Setting the Date and Time from the Computer

You can let the computer set the date and time in the Screener to match its settings. This ensures that the date and time stamp associated with each test result does not conflict with the computer clock.

If you want to set the Screener's date and time from the computer, you must install the GSI 70 DMS on the computer. If you are using the Printer/Charger to allow the Screener to communicate with the computer, attach the serial cable to the Printer/Charger.

See the GSI 70 DMS manual for the steps to install and start the software. Also see *Connecting the Printer/Charger to Mains Power* on page 13 or *Connecting the Optional IrDA Adapter to a Computer* on page 12.

To set the date and time in the Screener from the computer:

1. Start GSI 70 DMS and begin the process for transferring date and time to the Screener (see the GSI 70 DMS manual for details).
2. Press any button to turn on the Screener.
The Screener performs a brief self-test and displays one of the following screens depending on its state the last time someone used the Screener:
 - Last test stored
 - Blank DPGram if the patient test database is empty
3. Press the DATA (pink) button on the screener, then touch DATE with the stylus.
The SET DATE AND TIME screen appears.
4. Do one of the following:
 - Place the Screener in the (powered) Printer/Charger cradle
 - Point the Screener toward the IrDA port on the computer
5. Touch LOAD.
The POSITION FOR LOAD screen appears. The computer automatically transfers the computer's date and time settings to the Screener. When complete, the Screener returns to the data screen.

The Screener's internal clock is synchronized to the computer. The Screener automatically records the date and time of each test you run. The test's date and time appears on all printouts, and is sent to the GSI 70 DMS when you download patient test data to the computer.

Setting Date and Time Using the Touchscreen

From the Screener's touchscreen, you can manually set the day, month, year, hour, and minute, in any order.

The Screener will not accept a day less than 1 or more than 31, or a year before 1999 or after 2095. In addition, the Screener verifies that you entered a valid date, and indicates any invalid entries, such as June 31. The Screener also checks for the leap year status, and

indicates an invalid date for February 29 in a non-leap year.

To set the date and time from the touchscreen:

1. Press any button to turn on the Screener.

The Screener performs a brief self-test and displays one of the following screens depending on its state the last time someone used the Screener:

- Last test stored
- Blank DPGram if the patient database is empty

2. Press the DATA (pink) button on the screener, then touch DATE with the stylus (stored in the Screener body)

The SET DATE AND TIME SCREEN appears and the day element is highlighted.

3. Touch any of the date or time elements with the stylus.

4. Press the left or right arrow buttons to adjust the selected element.

The left arrow decreases the value and the right arrow increases the value. As you adjust the element, the screen displays the current setting.

5. To set another element, repeat steps 3 and 4.

6. When done, press STORE.

The Screener verifies that the dates entered are valid (such as making sure you did not select June 31). If there is a problem, the Screener highlights the DAY element and lets you correct it. If the settings are valid, the Screener returns to the DATA screen.

Cleaning

You can clean the following components of the GSI 70 Automated OAE Screener

System:

- Exterior of the Screener and PCM
- LCD display
- Cables
- IrDA port windows and charging contacts
- Probe tips



The eartips are intended for a single use only. Discard after use.

Cleaning the Housings, Display, and Cables

To clean the exterior of the GSI 70 Automated OAE Screener (including the display), the Pod and Printer/Charger, and the cables, use a lint-free cloth moistened with either:

- Plain water
- Water and a mild detergent/soap solution
- 70% isopropyl alcohol



To avoid damaging the instrument, do not:

- Spray anything directly onto the Screener display
- Immerse instruments in water or cleaning solutions
- Autoclave the instruments

Cleaning the Probe Tips

Clean the probe tips with the supplied Cleaning Kit:

- At the start of every day or shift
- After testing an ear that contained cerumen, vernix, or other material
- The following events could indicate blocked probe tubes:
 - Quick Check test fails
 - Screener reports unusual numbers of REFER results
 - Screener repeatedly cannot achieve a seal in a patient's ear

There are three parts to the probe tip cleaning process:

- Removing the probe tip from the probe
- Cleaning the probe tip
- Attaching the probe tip to the probe

Removing the Probe Tip

The probe tip is held in place by three tabs that fit into notches in the probe. The probe tip sits on a firm rubber gasket that provides pressure to hold the probe tip in place.

To remove the probe tip:

1. Push the probe tip into the probe to compress the rubber gasket, and turn the probe tip counter-clockwise about one-sixteenth turn.
2. Lift out the probe tip.



The probe is vulnerable to dust and moisture. Do not put the probe on a dirty or wet surface.

Cleaning the Probe Tip

To clean the probe tip:

1. Moisten a tissue or lint-free cloth with 70% isopropyl alcohol.
2. Push the large cleaning wire through the large diameter probe tube, from the back (large end) toward the front.

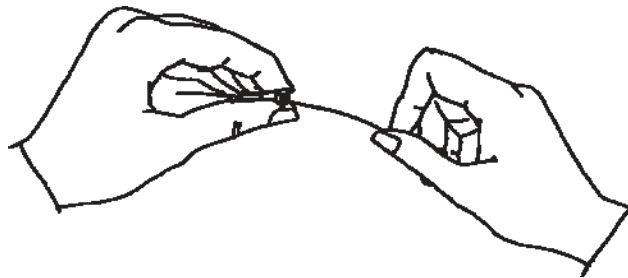

3. Wipe off the cleaning wire with the moistened tissue, then pull the wire back out of the tube.
4. Push the smaller cleaning wire through one of the smaller diameter probe tubes, from the back toward the front.
5. Wipe off the cleaning wire with the moistened tissue, then pull the wire back out of the tube.

6. Repeat steps 4 and 5 for the other small probe tube.



Do not attempt to clean probe tip while attached to probe. Debris may become lodged in probe.

Attaching the Probe Tip to the Probe

To attach the probe tip to the probe:

1. Align the tabs on the probe tip with the notches in the probe, so that the white alignment markers on each piece are between the same pair of notches.
2. Push the eartip firmly into the probe, and turn clockwise about one-sixteenth turn.

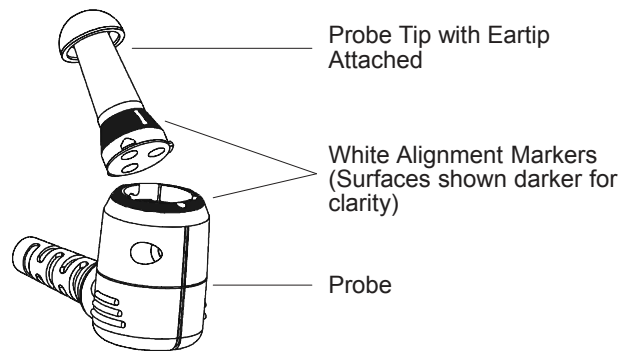

When the probe tip is correctly locked in place, the white alignment markers line up.

Cleaning the Infrared Port Windows and Charging Contacts



Disconnect the Printer/Charger from Mains power before cleaning the charging contacts.

Use a lint-free cloth moistened only with water to clean:

- Charging contacts in the Printer/Charger
- Infrared port windows on the Screener and the Printer/Charger

Recharging the Battery

To recharge the battery, do one of the following:

- Plug the Printer/Charger into the Mains outlet. Place the Screener in the Printer/Charger cradle.
- Connect the round DIN connector of the optional Charging Transformer to the Screener, then plug the transformer (or the attached cable) into the Mains outlet.

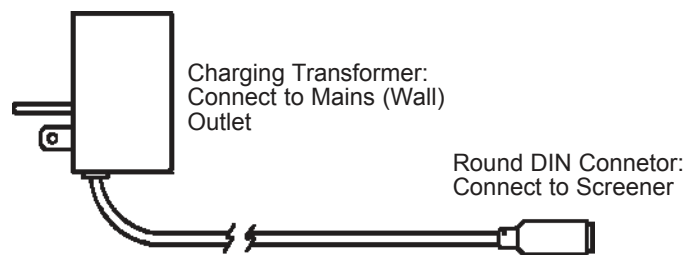

Charge the Screener *only* in the Printer/Charger or with the specified Charging Transformer.



Do not charge the battery if the ambient temperature exceeds 113°F (50°C). Charging the battery at high temperatures causes the battery to overcharge and become extremely hot. This will ruin the battery and possibly damage the instruments.

Both Printer/Charger LEDs are turned on. The TEST key is disabled so that the Screener will not conduct any tests while connected to mains power. After 45 seconds of inactivity, the Screener will be turned off.

The Screener may be charged indefinitely (longer than five hours) without damage to the battery. Slight heating of the Screener while charging is normal.

Removing or Replacing the Battery

1. Using your thumb, turn the battery cover screw counterclockwise approximately one-half turn. The retaining screw is attached to the battery cover; it pops halfway out of the hole but remains attached to the cover.

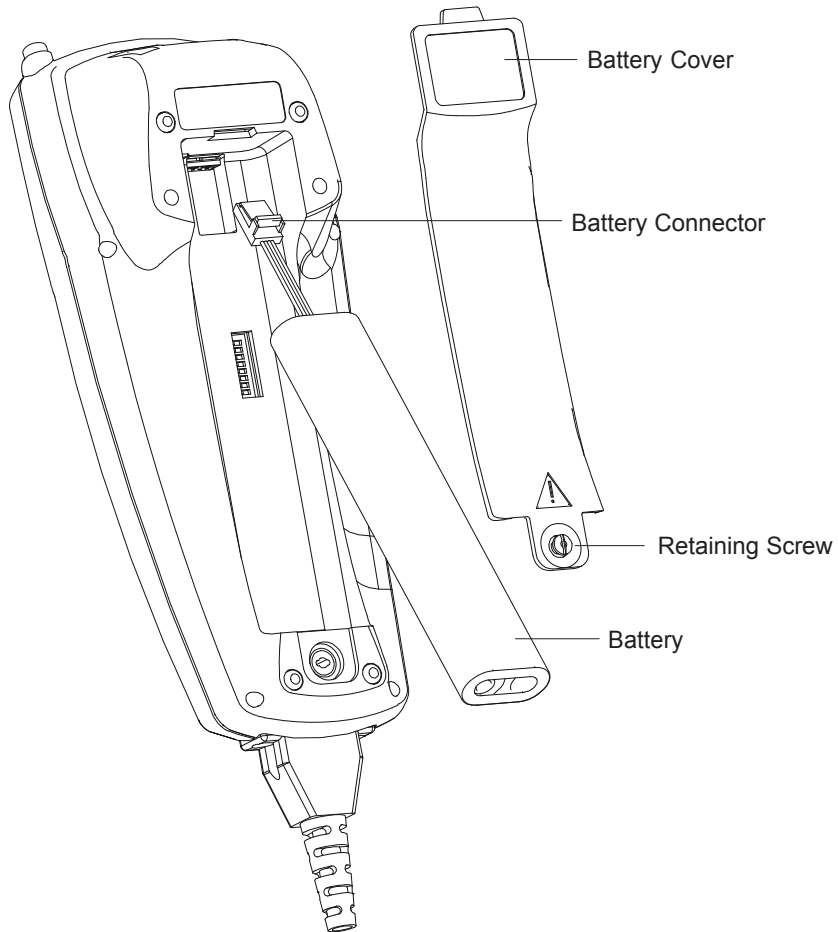

2. Pull gently on the retaining screw until the cover lifts out.
3. Press the tab on the battery connector and pull the two halves apart. Lift out the battery.
4. Align the connector on the replacement battery with the connector in the Screener, and slide the connector in until the tab locks into place. You will hear a click when it locks.

Install the battery as shown. The two parts of the connector are keyed and fit together only one way.

5. Replace the battery cover by sliding the cover's tab into the notch in the Screener, then fitting the cover into place.
6. With your thumb, push the screw down into the hole and turn approximately one-half turn clockwise to tighten. Do not over-tighten.



When removed from the Screener, the battery discharges gradually over a period of approximately a year when stored at room temperature (70°F / 21°C); storage at higher temperatures increases the discharge rate. Long-term storage does not affect the battery's recharge capacity.



Remove the battery if you plan to store the Screener or place it anywhere other than in the powered Printer/Charger Module for more than one month. After you remove the battery, do not place the Screener in the powered Printer/Charger Module.

Disposing of the Battery

When the Nickel-Cadmium battery loses its capacity to be recharged, please dispose of it according to the environmental regulations in your area.



THE NICKEL-CADMIUM BATTERY MUST BE RECYCLED OR
DISPOSED OF PROPERLY.



If the battery is removed for more than five minutes, the Date and Time settings in the Screener will be lost.

Checking the Screener

Use the supplied Quick Check Cavity to perform a rapid functional check of the Screener. This is a simple test to perform and indicates that the Screener is working properly.

Grason-Stadler recommends using the Quick Check Cavity at least daily. For example, your department or facility might decide to check the Screener at the start of each shift.

The test, which takes about 10 seconds, detects:

- Plugged microphone or speaker chambers in probe
- Change in speaker or microphone sensitivity
- Loss of output from one or both speakers
- Loss of output from microphone

Running the Quick Check Test

To run the Quick Check Test:

1. Simultaneously press the left and right (blue and pink) buttons.

The Utilities Menu appears on the display. An arrow points to the first menu option, QUICK CHECK TEST.

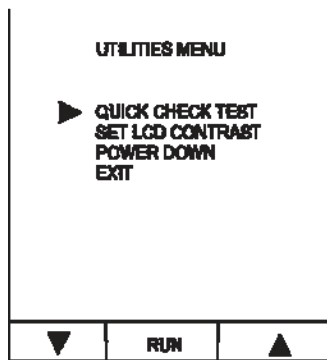

Single-Patient Model

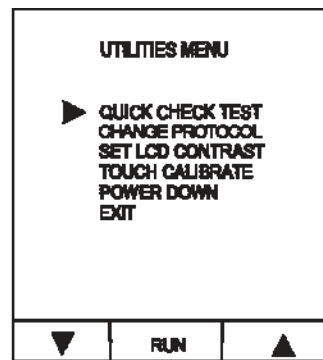

Multi-Patient Model

2. Press RUN.

The Quick Check Test screen appears.

3. Attach a 4mm eartip onto the probe tip.
4. Insert the probe into the Quick Check Cavity.
5. Press NEXT.

The Screener quickly performs several tests, and some numbers appear briefly on the display. You do not need to observe these numbers. When finished, the Screener displays the test result.

Quick Check Passed

If the Screener passed, you may perform OAE tests.

1. Press NEXT to return to normal testing mode.
2. See *Using the Single-Patient Screener* on page 21, or *Using the GSI 70 Multi-Patient Screener* on page 29.

Quick Check Failed

1. Inspect the tubes in the probe tip. The tubes may be blocked with cerumen or other material.
2. Clean the probe tip. See *Cleaning the Probe Tip* on page 57.
3. Run the Quick Check test again.
4. If the Quick Check fails a second time, press NEXT to return to normal testing mode and allow the Screener to turn off.
5. Replace Probe/Pod assembly by removing the screws from the connector, if you have a spare probe.
6. Ensure that the pink (4mm) eartip is totally seated on the probe tip and that no part of the eartip blocks the small metal tubes.
7. Contact your GSI Service Representative. The Probe/Pod assembly requires service before you can use it again.

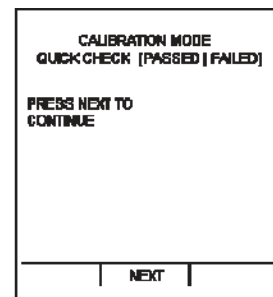
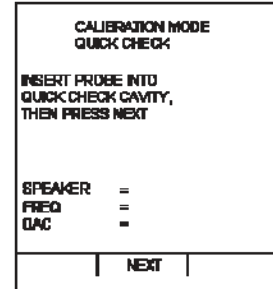

Calibrating the Touchscreen

The Multi-Patient Screener contains a touch-sensitive layer (called the touchscreen) over the LCD that responds to pressure from a stylus. This touchscreen allows you to enter new patient names or ID numbers as you work, and also provides access to additional functions through touchscreen “buttons” on the LCD.

As you use the Multi-Patient Screener, if you notice that the areas you touch with the stylus do not respond properly or if a different command is activated, this indicates that the touchscreen’s calibration has drifted. This drifting may occur due to vigorous handling, or extremes of heat and cold. At any time, you can calibrate the touchscreen.

To calibrate the touchscreen:

1. Press any button to turn on the Screener.

The Screener performs a brief self-test and displays one of the following screens depending on its state the last time someone used the Screener:

- Last test stored
- Blank DPGram if the patient database is empty

2. Press the left (blue) and right (pink) buttons simultaneously.

The UTILITIES MENU appears.

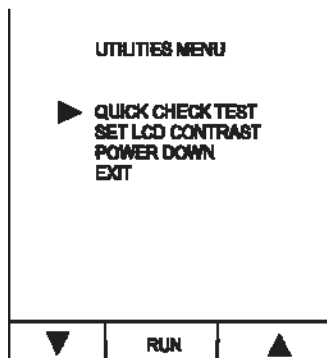

Single-Patient Model

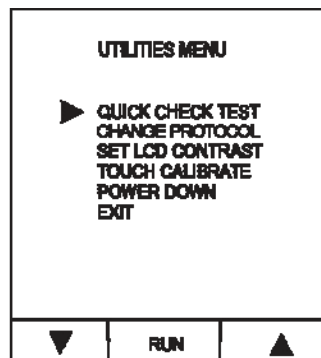

Multi-Patient Model

3. Press the down arrow to move the cursor to the TOUCH CALIBRATE option, and then press RUN.

The TOUCHSCREEN CALIBRATION screen appears.

4. Use the stylus (stored in the body of the Screener) to press the small box on the display. Use steady pressure and do not let the point of the stylus slip. Hold the stylus on this box until the NEXT message appears, and then remove the stylus.

5. Follow the next step, again holding the stylus on the NEXT box that appears on the display.

6. When prompted, remove the stylus.

The touchscreen calibration is complete, and the Screener returns to the UTILITIES MENU.

7. Press the down arrow to move the cursor to the EXIT option, and then press RUN.

The Screener returns to the display that appeared when you turned it on.



Checking the Printer/Charger

When you connect the Printer/Charger to Mains power, it performs a self-test. It also checks whether the printer is out of paper and identifies any other error conditions.

- If the printer is out of paper, the POWER/STATUS LED () flashes singly. Install a new roll of paper (see *Replacing the Paper* on page 67). The LED stops flashing when the paper is installed.
- If the printer is malfunctioning, the POWER/STATUS LED flashes doubly. Disconnect the Printer/Charger from Mains power and wait about five minutes before reconnecting to power. The printer may be overheated, and this allows it to cool down. If this does not correct the problem, the Printer/Charger may require service. Contact your local GSI Service Representative. (You may continue to use the Printer/Charger to charge the Screener).

Printing a Test Pattern

You can check the printer quickly by printing out a test pattern. This lets you verify that the printer is working.

To print a test pattern:

1. Make sure that:
 - Printer/Charger is plugged into Mains power and contains paper
 - POWER/STATUS LED is lit
 - No LEDs are flashing
2. Simultaneously press the PRINT and ADVANCE buttons. The printer prints a test pattern:



This test pattern indicates that the printer is working properly.

If the test pattern does not print out or if you see any flashing LEDs, consult Table 4 on page 74.

About the Printer Paper

Use only:

- Heat-sensitive paper available from Grason-Stadler (#1738-9600).
- Adhesive-backed paper available from Grason-Stadler (#1770-9602).



Using the wrong paper can wear out the printer prematurely and may void the warranty.

The paper is thermally activated. Before use, store the paper in a cool, dark location to prevent exposure and degraded performance. After printing test results, store the printouts in a cool, dark place such as a patient's file folder. Exposure to light, sun, and heat will degrade the printing, and over time the results will be illegible.

Only one side of the paper is thermally active; no printing will appear on the paper if you insert it backwards.

Do not use transparent adhesive tape on printed portions of the printout, as those portions will fade.

When to Replace the Paper

Replace the paper roll in the Printer/Charger when either of the following happens:

- A pink strip appears along the edge of the paper, indicating the paper is nearing the end of the roll
- The power/status indicator flashes in single pulses, indicating the printer is completely out of paper

Replacing the Paper

To replace the paper:

1. Remove the eartip box from the well of the Printer/Charger.
2. Press the depression on the back edge of the paper cover to release the latch.
3. Carefully lift the back of the cover up and out of the Printer/Charger.
4. Lift out the paper roll and tear off any remaining paper against the back edge of the paper well.

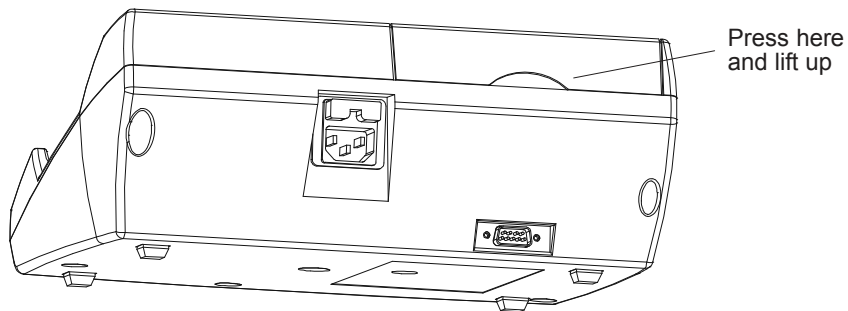

 Do not pull the paper backwards out of the printer. This will damage the mechanism.

5. Press ADVANCE to remove the remaining paper.

- 6 Place a new roll of paper in the cavity, with the paper's leading edge coming from underneath the roll, toward the front of the cavity, like this:
7. Make sure the new paper has a straight edge. Feed the leading edge squarely into the paper guide. The printer automatically pulls the paper in and stops when the paper's top edge is positioned correctly. If the paper is not evenly aligned with the cutting edge, tear off the new roll, trim the edge, remove the remaining paper using ADVANCE, and try again.
8. Replace the printer cover, first inserting the tabs into the notches, then pressing the back edge down until it clicks into place.
9. Replace the ear tip box in the well.
The POWER/STATUS LED stops flashing, and the Printer/Charger is ready to print tests.



This chapter covers:

- Error messages that may appear on the Screener
- Possible causes and solutions for problems with the Screener or Printer/Charger

Error Codes

If an error message followed by two sets of numbers appears on the display, for example:

ERROR 25 802

or

ERROR 5017 14

indicates the Screener requires service before you can use it again.

If this happens:

1. Allow the Screener to turn off.
2. Contact your local Service Representative.

Troubleshooting Tips

Screener Problems

If you think your Screener is not working properly, consult Table 3 to find the symptom and the likely cause and its solution. If the information in this table does not describe or solve the problem you are having, call Technical Support. See *Service and Warranty Information* on page 79 for more information.

What to Check First

Make sure the Screener has a battery installed. See *Removing or Replacing the Battery* on page 60.

Table 3 – Troubleshooting Guide for the Screener

Problem	Possible Cause	Solution
Screener will not turn on	Battery drained	Charge the battery. See <i>Recharging the battery</i> on page 59.

Table 3 – Troubleshooting Guide for the Screener (Continued)

Problem	Possible Cause	Solution
Screener will not run tests (LED blinks but no test starts)	Screener in Printer/Charger cradle	Remove Screener from Printer/Charger cradle and try again. (Screener will not run tests while in contact with power source)
	Screener connected to Charging Transformer	Unplug from Charging Transformer and try again. (Screener will not run tests while in contact with power source)
	Probe malfunction	Run the Quick Check test. See <i>Running the Quick Check Test</i> on page 62. If Screener fails, call your local service representative.
	Loose cable	Check cable connection between Screener and Pod. Tighten the screws if necessary.

Table 3 – Troubleshooting Guide for the Screener (Continued)

Problem	Possible Cause	Solution
Screener does not recharge	Printer/Charger is not plugged in	Plug cable into back of Printer/Charger, then into Mains (wall) outlet.
	Charging contacts are blocked or dirty	Inspect and clean charging contacts in Printer/Charger and on Screener. <i>See Cleaning the Housings, Display, and Cables on page 56.</i>
	Screener not seated properly in Printer/Charger cradle	Remove and replace Screener in cradle.
	Charging Transformer is not connected properly	Plug round end of Charging Transformer into back of Screener, plug large square end into Mains (wall) outlet. <i>See Recharging the Battery on page 59.</i>
Cannot see anything on Screener display, but LCD is illuminated	Contrast is out of adjustment	<i>See Adjusting the LCD Contrast on page 11.</i>

Table 3 – Troubleshooting Guide for the Screener (Continued)

Problem	Possible Cause	Solution
Yellow LED appears on Pod	Probe not seated properly in ear canal	Reposition eartip in ear canal. Align eartip straight in for adults and children, slightly anterior for infants and newborns. Try a different size eartip.
	Probe tip not fully attached to Probe	Remove and reattach probe tip; make sure white marks in probe and probe tip line up. See <i>Attaching the Probe Tip to the Probe</i> on page 58.
	Probe tip blocked	Remove and inspect the probe tip. Clean if necessary. See <i>Cleaning the Probe Tip</i> on page 57. Run the Quick Check test. If Screener fails, call your local Service Representative.
Screener displays incorrect language	DIP Switches set wrong	See <i>Changing the Language Setting for the Screener</i> on page 94.
Screener comes up in Diagnostic or Calibration Mode	DIP Switches set wrong	Call your local Service Representative.
Touchscreen does not respond properly or at all (in Multi-Patient Screener)	Touchscreen not calibrated properly	Calibrate the touchscreen. See <i>Calibrating the Touchscreen</i> on page 64.

Printer/Charger Module Problems

If you think your Printer/Charger Module (PCM) is not working correctly, consult Table 4 to find the symptom and the likely cause and its solution. If the information in this table does not describe or solve the problem you are having, call your local GSI Service Representative. See Service and Warranty Information on page 77 for more information.

What to Check First

Make sure the PCM is connected to Mains power. If the PCM is connected properly and has no other malfunctions, the power/status LED will be on.

Table 4 – Troubleshooting Guide for the Printer/Charger

Problem	Possible Cause	Solution
Printer Prints “No Screener”	Screener not seated properly in PCM	Remove and replace screener in cradle.
Printer prints “No Data”	Screener contains no test data	Run and save a test for one or more ears.
	If Screener does contain data, the PCM or Screener has an internal malfunction.	Call your local Service Representative.
	Infrared port window is blocked or dirty.	Inspect and clean Infrared port windows in PCM and on Screener. <i>See <i>Cleaning the Housings, Display, and Cables</i> on page 56.</i>

Table 4 – Troubleshooting Guide for the Printer/Charger (Continued)

Problem	Possible Cause	Solution
Printer does not print anything	Printer is out of paper.	Replace paper. <i>See Replacing the Paper on page 67.</i>
	Infrared port window is blocked or dirty.	Inspect and clean Infrared port windows in PCM and on Screener. <i>See Cleaning the Housings, Display, and Cables on page 56.</i>
Printer prints “Removed too soon”	Screener removed from PCM before test data finished downloading.	Leave Screener in PCM for three seconds after you press print, for single-patient unit or if multi-patient unit and printing one test. If multi-patient and printing many tests, leave Screener in PCM for duration of printing until TRANSFER COMPLETE is displayed.
Power/Status LED flashing singly	Printer is out of paper.	Replace the paper. <i>See Replacing the Paper on page 67.</i>

Table 4 – Troubleshooting Guide for the Printer/Charger (Continued)

Problem	Possible Cause	Solution
Power/Status LED flashing doubly	Printer may be too hot.	Unplug the Printer/Charger for about five minutes. Plug back into Mains power. If LED still flashes, call your local Service Representative. You can still use the Printer/Charger to charge the Screener.
Pink strip appears on paper	Paper is almost used up.	Replace paper. See <i>Replacing the Paper</i> on page 67.

What are Otoacoustic Emissions?

Otoacoustic emissions (OAEs) are sounds generated within the cochlea of all normal-hearing ears by active biomechanical processes within the outer hair cells. Since normal ears produce OAEs, the absence of an emission is a reliable sign of abnormal cochlear function, which could indicate hearing loss.

Otoacoustic emissions testing provides a fast, non-invasive method of testing for cochlear pathology. In addition, OAE testing is completely objective—making it ideal for hard-to-test patients such as infants, young children, or neurologically impaired patients.

How is an OAE Generated and Detected?

The OAE probe, similar to a tympanometry probe, contains two speakers and a microphone. Eartips cover the probe and seal the ear canal tightly. The probe speakers send tones to the ear canal. These tones travel through the middle ear and into the cochlea. Outer hair cells in the cochlea react to the tones by generating and emitting a third tone. This third tone then travels outward from the cochlea back through the middle ear to the ear canal, where the probe microphone detects it.

This emitted response has a very small amplitude and gets mixed in with other biological and environmental sounds present in the ear canal. Since the probe microphone detects all of these sounds, the instrument must use signal averaging techniques to separate the emitted response — OAE — (signal) from these other sounds (noise).

Since the microphone measures the response at the entrance to the ear canal, rather than at the site of its origination (the cochlea), the anatomy along the return path (i.e., the ossicular chain and the tympanic membrane) can influence the amplitude of the response. To identify these effects, measure the status of the middle ear using tympanometry screening whenever possible.

Testing with the GSI 70 Automated OAE Screener

The GSI 70 Automated OAE Screener uses Distortion Product Otoacoustic Emissions. Distortion Product Otoacoustic Emissions are emissions resulting from the presentation of a series of primary tone pairs.

The stimulus consists of a series of pure tone pairs. The instrument presents each tone pair and measures the OAE in an ascending or descending frequency pattern.

When the tone pair reaches the cochlea, each tone stimulates a different group of outer hair cells. As these two different groups are stimulated, they vibrate—causing a third tone to be generated between the two groups. This third tone is known as the *distortion product* (DP).

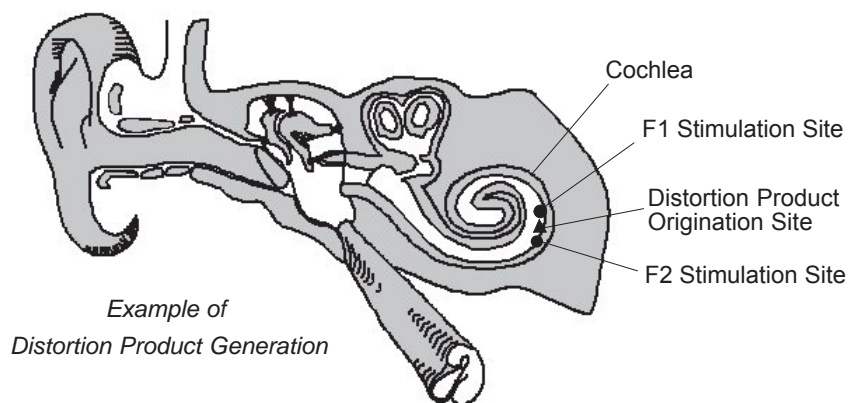

The relationship between the tone pair's frequencies and intensity levels has an effect on the amplitude and frequency of the DP response. The lower frequency in each pair is referred to as F1. The higher frequency is F2.

Researchers have shown that an F2 to F1 ratio ($F2/F1$) of 1.2 (or 1.22) produces the most robust response in humans. Also, using a higher-intensity stimulus for F1 than F2 (by approximately 10 dB) provides greater test sensitivity.

The response from the cochlea during DP testing consists of a single frequency per tone pair presentation. The frequency of the DP equals $2F1 - F2$. Since the frequency of the DP occurs within a narrow range, the instrument needs to use signal averaging only within a very narrow frequency band for each data point.

The equation $2F1 - F2$ also tells the DPOAE system what specific DP response frequency to look for. Thus, the system can disregard any other tones that are present in the ear canal—making DPOAE testing far less sensitive to room noise than other test methods.

The GSI 70 Automated OAE Screener displays DPgrams as a function of the F2 frequency.

Service and Warranty Information 10

Warranty for the Screener and Printer/Charger

Grason-Stadler warrants the GSI 70 Automated OAE Screener and Printer/Charger to be free of original defects in material and workmanship and to perform in accordance with manufacturer's specifications for a period of one year from the date of purchase. If this instrument or any component thereof is found to be defective or at variance from the manufacturer's specifications during the warranty period, Grason-Stadler will repair, replace, or recalibrate the instrument or component at no cost to the purchaser.

This warranty only applies to instruments purchased new from Grason-Stadler or its authorized distributors or representatives. The purchaser must return the instrument directly to Grason-Stadler or an authorized GSI 70 Automated OAE Screener distributor or representative and bear the costs of shipping.

This warranty does not cover breakage or failure due to tampering, misuse, neglect, accidents, modification, or shipping, and is void if the instrument is not used in accordance with manufacturer's recommendations or if repaired or serviced by other than Grason-Stadler or a Grason-Stadler authorized representative.



Please return the instrument registration card for proof of purchase and warranty validation.

Repair

Repair must be performed by authorized factory-trained personnel. Failure to do so invalidates the GSI 70 Automated OAE Screener warranty.

Technical Service Department

For customers in North America, please return instruments requiring service to the Grason-Stadler Technical Service Department or to an authorized Grason-Stadler Service Representative.

Please call the Technical Service Department for a Return Authorization Number prior to shipping the GSI 70 back to GSI for repair.

Grason-Stadler
7625 Golden Triangle Drive, Suite F,
Eden Prairie, MN 55344 USA

Telephone: 1-800-700-2282
Fax: 952-278-4401

Recalibration

Grason-Stadler recommends that the GSI 70 Automated OAE Screener be recalibrated annually. You can make arrangements for calibration by contacting an authorized Grason-Stadler representative. A moderate fee is charged for recalibration.

The Printer/Charger does not require calibration.

Replacement Parts and Accessories 11

Ordering Information

To order replacement parts or accessories, contact your local Grason-Stadler representative or call the Customer Service Department in Eden Prairie, MN.

Eartips

All eartips are packaged 100 per bag.

**Table 5 – Replacement Eartips
(Bulk Quantity of 100 each)**

Eartip Size	Part Number
3.5 mm	1770-9603
4 mm	1770-9604
5 mm	1770-9605
6 mm	1770-9606
7 mm	1770-9607
8 mm	1770-9608
9 mm	1770-9609
10 mm	1770-9610
11 mm	1770-9611
12 mm	1770-9612
13 mm	1770-9613
14 mm	1770-9614

Eartip Starter Kit - 1770-9660 (four each sizes 3.5 - 14mm)

**Table 6 – Replacement Eartips
Bulk Quantity of 25 each**

Size	Group	Part Number
3.5 - 7 mm	Infant	1770-9662
7 - 11 mm	Child/Adult	1770-9663
10-14 mm	Adult	1770-9664

Screener Parts and Accessories

Table 7 – Screener Parts and Accessories

Item	Description / Comments	GSI Part Number
Probe Tip Molded black plastic piece with three metal tubes inside, that locks onto the Probe	Replacement probe tip	1770-9661
Probe Tip Cleaning Kit	Consists of thin cleaning wire and thick cleaning wire	1770-9670
Pod/Probe Assembly	Fully calibrated replacement assembly	1770-9690
Rechargeable Battery	1 each	1770-9672
Charging Transformer	Charges the Screener directly from Mains power	Varies by country. See Table 12 on page 97 or call Customer Service.
Battery Charger	Accessory that charges a spare battery while the Screener is in use	1770-9615 (North America)
GSI 70 Automated OAE Screener Only	Single-Patient Model:	1770-9708
	Multi-Patient Model:	1770-9705
Upgrade Kit for Screener	Upgrades a Single-Patient Screener to a Multi-Patient Screener Requires installation by a Service Representative	1770-9630
Carrying Case, Screener	Holds the Screener and a box of eartips	1770-9688
Carrying Case, System	Holds the Screener and the Printer/Charger	1770-9689
Quick Check Cavity	Allows functional check of the Screener	1770-1020

Table 7 – Screener Parts and Accessories (Continued)

Item	Description / Comments	GSI Part Number
Footswitch	Allows hands-free operation (starting tests)	1770-9676
Rolling Stand with Shelf	Supports Screener in holder, Printer/Charger and eartips on shelf	1770-9675
Stylus	Used with Multi-Patient touchscreen	1770-6020

Printer/Charger Parts and Accessories

Table 8 – Printer/Charger Parts and Accessories

Item	Description / Comments	GSI Part Number
Thermal Paper	Five rolls of printer paper	1700-9627
Adhesive paper	Five rolls of printer paper	1770-9602
Printer/Charger	Complete replacement, including two rolls of paper	1770-9710
Training material	Video tape and instructional booklet Consisting of: Instructional Booklet, GSI 70 (1770-0195) Video tape VHS USA (1770-9693)	1770-9695
Training material (International)	Video tape and instructional booklet Consisting of: Instructional Booklet, GSI 70 (1770-0195) Video tape PAL INT GSI (1770-9694)	1770-9696

General Specifications

The specifications common to all the major components of the GSI 70 Automated OAE Screener System are listed in Table 9. Specifications that apply only to the individual components appear in the section for that component.

Table 9 – General Specifications

	Screener	Printer/Charger	Charging Transformer
Standards	Y2K Compliant UL 2601-1 Part 1: General Requirements for Safety CSA C22.2 No. 601.1-M90 (Canada)  CE Mark per Medical Device Directive (93/42/EEC) 0344 European Representative: European Authority Representative Grason-Stadler A/S Kongebakken 9 2765 Smorum Denmark EN60601-1:1990 Safety Requirements for Medical Electrical Equipment EN60601-1-2 Medical Electrical Equipment Emissions and Immunity Requirements		
Weight	1.5 lbs (0.68 kg)	With printer and paper: 3.88 lbs (1.76 kg) Without printer and paper: 3.25 lbs (1.48 kg)	See Table 13 on page 98
Dimensions	See <i>Screener, Pod and Probe Dimensions</i> , on page 93	See <i>Printer/Charger Dimensions</i> , on page 96	See <i>Charging Transformer Dimensions</i> , on page 98

Table 9 – General Specifications (Continued)

	Screener	Printer/Charger	Charging Transformer
Electrical	<p>Runs on rechargeable battery (cannot run tests directly from Mains power) Input current: 1000 mA under peak load Input voltage: 7.2 V supplied by battery Battery provides power for testing up to 100 ears over an eight-hour period without recharging</p>	<p>Input voltage: 90-260 VAC Input frequency: 50-60 Hz Input current: 1.0A maximum IEC Mains connector (hospital grade) Charging contacts: output voltage +24 VDC + 1%</p>	<p>See Table 12 on page 97</p>

Table 9 – General Specifications (Continued)

	Screeener	Printer/Charger	Charging Transformer
Electrical	Pod Connector		
	Pin	Function	
	1	Switched Battery, 6.0 - 8.6 VDC	
	2	DC Ground	
	3	Pod Detect, Input, Zin - 10KOhm	
	4	Start Button, Input, Zin=10Ohm	
	5	Serial Data, Bidirectional, Zin=10KOhm, Zout=1KOhm	
	6	Serial Select, Output, Zout=1KOhm	
	7	Spare	
	8	Serial Clock, Output, Zout=1KOhm	
	9	Home, Input, Zin=10KOhm	
	10	SP1 +, Speaker #1 high side drive, Output, Zout=1KOhm	
	11	SP1 -, Speaker #1 Low side, (Analog Ground)	
	12	SP2 +, Speaker #2 high side drive, Output, Zout=1KOhm	
	13	SP2 -, speaker #2 Low side, (Analog Ground)	
	14	Pressure, Input, Zin=22KOhm	
	15	Mic +, Input, Differential, Zin=3KOhm	
	16	Mic-, Input, Differential, Zin=3KOhm	
	17	Reserved	
	18	Reserved	
	19	Reserved	
	20	Reserved	
	21	Shield Ground	
	22	Unused	
	23	Unused	
	24	Unused	
25	Unused		
26	Unused		
	DIN Connector		
	Pin	Function	
	1	Charger Vin=5-25VDC, Iin=400 Ma to 85 Ma	
	2	Unused	
	3	AC Ground	
	4	Foot Switch Input, Zin =10KOhm	
	5	DC Ground	
Operating Temperature	59°F to 95°F (15°C to 35°C), 10% to 90% non-condensing humidity		Thermally protected up to 115°C 1.5A 250V

Table 9 – General Specifications (Continued)

	Screener	Printer/Charger																																												
Storage Temperature	-4°F to 104°F (-20°C to 40°C) 10% to 90% non-condensing humidity																																													
Storage Altitude	Sea level to 12,000 feet (~3657 meters)																																													
Communications	<p>Bidirectional communications with Printer/Charger or computer through an infrared link protocol that does not interfere with other IrDA devices</p>	<p>Computer Interface: Provides connection to a computer through a 9-pin serial interface (RS-232) and cable.</p> <p>RS-232 Connector:</p> <table border="1"> <thead> <tr> <th>Pin</th> <th>Function</th> <th>Max. Out Volts</th> <th>Impedance</th> </tr> </thead> <tbody> <tr> <td>2</td> <td>TXD</td> <td>+/- 8VDC</td> <td>800Ohm</td> </tr> <tr> <td>8</td> <td>RTS</td> <td>+/- 8VDC</td> <td>800Ohm</td> </tr> <tr> <td colspan="2"></td> <td>Max. In Volts</td> <td>Impedance</td> </tr> <tr> <td>3</td> <td>RXD</td> <td>+/- 30 VDC</td> <td>5KOhm</td> </tr> <tr> <td>7</td> <td>CTS</td> <td>+/- 30 VDC</td> <td>5KOhm</td> </tr> <tr> <td>5</td> <td>SIG_GND</td> <td>Signal ground</td> <td>0 Ohm</td> </tr> <tr> <td>1</td> <td>unused</td> <td></td> <td></td> </tr> <tr> <td>4</td> <td>unused</td> <td></td> <td></td> </tr> <tr> <td>6</td> <td>unused</td> <td></td> <td></td> </tr> <tr> <td>9</td> <td>unused</td> <td></td> <td></td> </tr> </tbody> </table> <p>Interface: Provides communications with the Screener through an infrared link.</p>	Pin	Function	Max. Out Volts	Impedance	2	TXD	+/- 8VDC	800Ohm	8	RTS	+/- 8VDC	800Ohm			Max. In Volts	Impedance	3	RXD	+/- 30 VDC	5KOhm	7	CTS	+/- 30 VDC	5KOhm	5	SIG_GND	Signal ground	0 Ohm	1	unused			4	unused			6	unused			9	unused		
Pin	Function	Max. Out Volts	Impedance																																											
2	TXD	+/- 8VDC	800Ohm																																											
8	RTS	+/- 8VDC	800Ohm																																											
		Max. In Volts	Impedance																																											
3	RXD	+/- 30 VDC	5KOhm																																											
7	CTS	+/- 30 VDC	5KOhm																																											
5	SIG_GND	Signal ground	0 Ohm																																											
1	unused																																													
4	unused																																													
6	unused																																													
9	unused																																													
Operation Time	Test Time: Sixty seconds maximum, from time of seal to completion of data acquisition for one ear, without error conditions.	Print Time: 10 seconds																																												

GSI 70 Automated OAE Screener Specifications

This section covers the specifications that apply only to the Screener.

Charging Time

- Ten-hour nominal charge time for completely discharged battery.

Probe Tones and Test Protocol

- The tone generation of this product complies with ANSI S3.6 1996 and IEC 645-1 Standards for Audiometers.
- The Screener contains built-in safeguards that limit the intensity of the test tones to ensure patient safety.

Table 10 – Parameters for Probe Tones and Default Test Protocol

Parameter	Value
Measurable Volumes	0.1 cc to 7 cc ear canal volume
F2/F1 Ratio	1.2
Tone Pairs	2 kHz, 3 kHz, 4 kHz (tone pairs are listed by the F2 frequency) If necessary, the frequency of each tone pair is shifted up by 3/64 octave.
Amplitudes	L1 = 65 dB SPL L2 = 55 dB SPL
DP Levels	-20 to +20 dB SPL (display range)
Sampling Rate	32,000 Hz
FFT Size	512 points

Eartips

- Bio-compatible, latex-free, insert type
- Color coded for size
- Single-use only
- Fit standard, round ear canals of 3.5 to 14 mm diameter

Display

- Liquid crystal type with EL back-lighting
- Resolution: 128 x 128 dots
- 1.763 in x 1.763 in (49mm x 49mm) minimum viewing area
- Viewing cone of 60° (maximum)
- Touch Sensitive (in Multi-Patient models only). Responds to pressure from a stylus. Stylus required to select or enter patient name/ID and display stored results.

Dimensions

The United States (Imperial) dimensions appear first, with the metric value in parentheses.

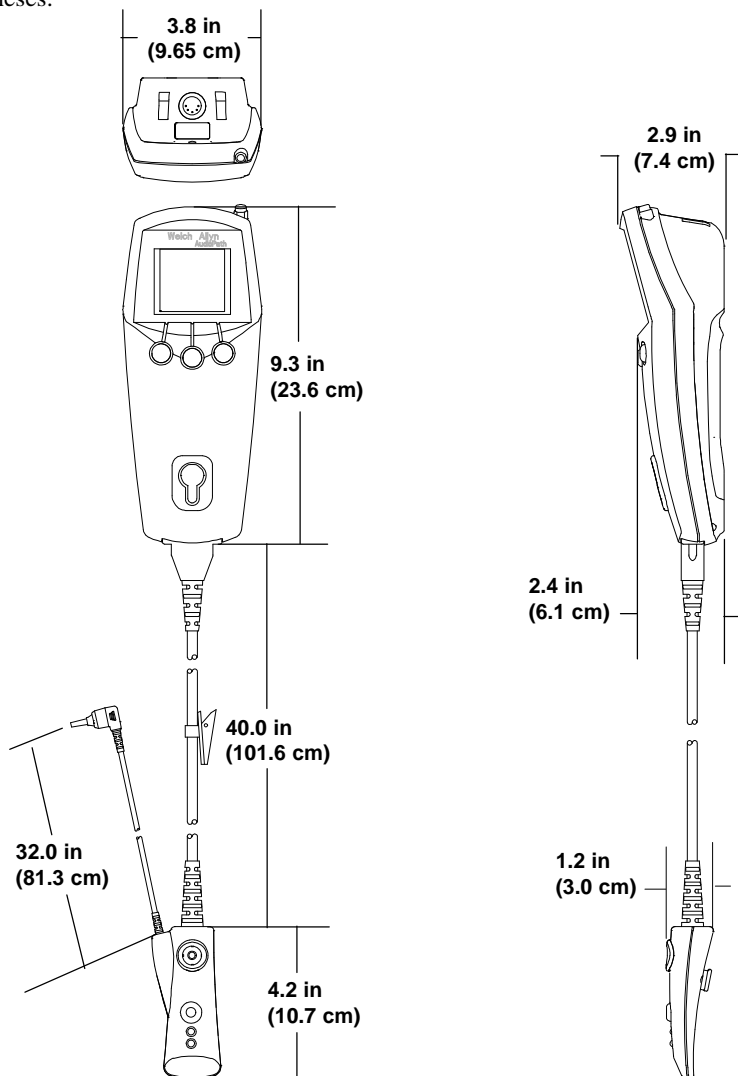

Screener, Pod and Probe Dimensions

DIP Switch Functions

The Screener has one 8-position DIP switch that controls the language settings, the Calibration modes, and the Diagnostic mode. The Calibration and Diagnostic mode switches are for Service Technician use only.

The DIP switch is located under the battery.

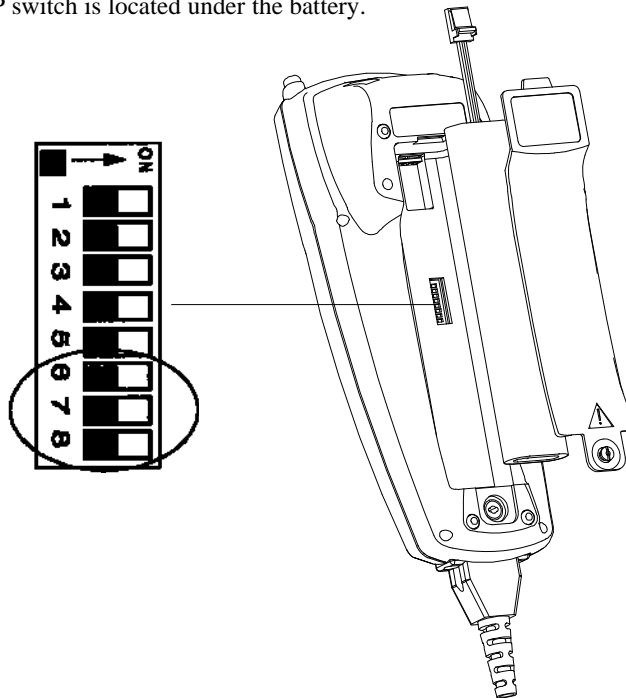

Location and Orientation of DIP Switches

Changing the Language Setting for the Screener

Grason-Stadler ships the Screener in one of four languages: English, French, German, and Spanish. However, you can change the language setting if necessary.



Hold the Screener in one hand as you follow the procedure, making sure that you do not press the left or right buttons. If you hold down a button for four or more seconds, the Screener erases any stored data for that ear (Single-Patient Model only).

To change the language setting:

1. Using your thumb or a flathead screwdriver (a thin coin or paper clip will also work), turn the battery cover screw counterclockwise approximately one-half turn.
2. Pull gently on the screw until the cover lifts out. Set the cover aside.
3. Lift up the battery to gain access to the DIP switch.
4. Use the plastic stylus shipped with the Screener to slide the switches into the positions specified in Table 9 for the language you choose.



Do not use a pencil or pen to move the DIP switches. The pencil lead could break off and fall into the Screener, or ink could leak into the switch or Screener and damage the instrument.

5. Reposition the battery and replace the battery cover.

When you turn the Screener on, it uses the selected language.

Table 11 – DIP Switch Positions for Language Selection

English	French	Spanish	German
<p>6 7 8</p> <p>All OFF</p>	<p>6 7 8</p> <p>6 ON</p>	<p>6 7 8</p> <p>7 ON</p>	<p>6 7 8</p> <p>6 and 7 ON</p>

Printer/Charger Specifications

This section covers the specifications that apply only to the Printer/Charger.

Dimensions

The United States (Imperial) dimensions appear first, with the metric value in parentheses.

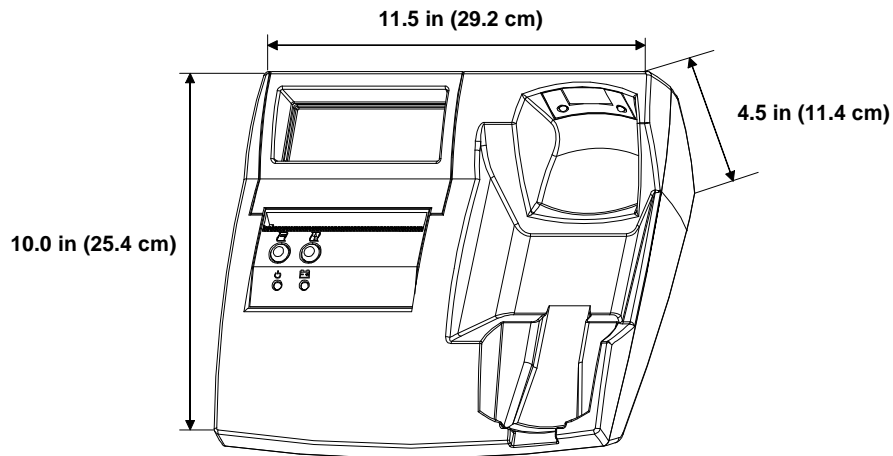

Printer/Charger Dimensions

Plain Paper

- 4.37 in. wide x 82 ft. long (111 mm wide x 25 m long)
- Pink end-of-roll indicator
- Approximate number of printouts per roll: 175

Adhesive-Backed Paper

- 4.37 in. wide x 27 ft. long (111 mm wide x 8.2 m long)
- Approximate number of printouts per roll: 55

Optional Charging Transformer Specifications

This section covers the specifications that apply only to the Charging Transformer.

The Charging Transformer is available in the configurations listed in the table below for most countries' electrical requirements.

Table 12 – Charging Transformer Electrical Specifications

Country	Transformer Part Number	Voltage	Frequency (Hz)
North America	8000-0260	100-120	50-60
Europe (EC Style)	8000-0261	220	50
United Kingdom	8000-0262	240	50
Europe (non-EC Style) and other countries	8000-0250*	220-240	50-60

* Requires country specific power cord

Dimensions

Refer to the following figure and table for the dimensions of the Charging Transformer.

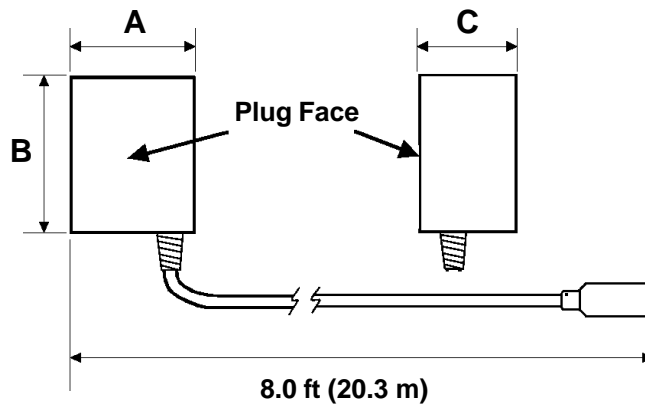

Charging Transformer Dimensions

Table 13 – Charging Transformer Dimensions

Part Number	A Inches (cm)	B Inches (cm)	C Inches (cm)	Weight Pounds (kg)
8000-0260	2.20 (5.58)	3.25 (8.25)	1.90 (4.83)	1.12 (0.51)
8000-0261	2.20 (5.58)	3.25 (8.25)	1.90 (4.83)	1.02 (0.46)
8000-0262	2.40 (6.09)	3.30 (8.38)	1.90 (4.83)	1.10 (0.50)
8000-0250	2.10 (5.33)	3.20 (8.38)	1.72 (4.37)	1.18 (0.54)

Index

A

- ABORT test result 23, 38, 52
- aborting a test. *See* stopping a test
- about 66
- adhesive paper
 - specifications 96
- adjusting
 - LCD brightness 11
 - LCD contrast 11
- advancing paper 8
- attaching
 - Pod and Screener 16
 - Probe and Pod 16
 - probe tip 58
- autopairing tests for printing 43

B

- back of printer/charger. *See* rear view of printer/charger
- battery
 - checking remaining charge level 11
 - discharge time 28, 61
 - disposal 61
 - low charge icon 28, 48
 - maximum charging temperature 6
 - removal for storing Screener 61
 - removing 60
 - replacing 60
- Battery LED 8
- brightness
 - adjusting 11
- button
 - PAPER ADVANCE 8
 - PRINT 8
 - VER #S 17
- buttons on
 - printer/charger 8
 - Screener and Pod 7

C

- calibration 80
- cancelling a printout 47
- cancelling a test. *See* stopping a test
- change the current test protocol 34
- changing language in Screener 95
- charging contacts
 - cleaning 58
- charging transformer
 - connecting to Screener 59
 - specifications 97
- CHECK SEAL message 23, 38
- checking
 - Printer/Charger performance 65
 - remaining battery charge 11
 - Screener 62
- cleaning
 - charging contacts 58
 - housings, display, cables 56
 - infrared port 58
 - probe tip 56–66
- cochlea
 - outer hair cells 77
 - stimulation 78
- codes
 - error 69
- communications
 - computer and Printer/Charger 90
 - Printer/Charger and computer 90
 - Screener and computer 90
- computer interface to Printer/Charger 90
- connecting
 - charging transformer to Screener 59
 - Pod and Screener 16
 - Probe and Pod 16
 - probe tip 58
- contents of the printout 25
- contrast, adjusting 11
- controls on
 - printer/charger 8
 - Screener and Pod 7

D

- DATA ERASED message 27
- DATA screen
 - numbers on top line 39
- date and time
 - resetting after removing the battery 53
 - setting from computer 53
 - setting from touchscreen 55
- delete a test protocol 35
- dimensions
 - printer/charger 96
 - Screener and Pod 93
- DIP switch specifications 94
- discharge time for battery 61
- disconnecting probe tip 57
- display
 - adjusting 11
 - noise floor symbol 19
 - Pass/Refer Line 18
- display mode 43
- displaying
 - tests 42
 - version number 17
- disposing of battery 61
- distortion product
 - symbol on display 19
- distortion product otoacoustic emissions.. *See* DPOAE
- downloading test results to computer 39
- DP
 - symbol on display 19
- DP (Distortion Product Otoacoustic Emissions) 77
- DP (distortion product) 78
- DPGram
 - stored 20

E

- eartip, selecting 14
- entering
 - names and ID numbers 31
- equipment, cleaning 56
- erasing a test 26, 41

- erasing characters on touchscreen 32
- error
 - during a test 65
 - indicator on Printer/Charger 65, 67
 - out of paper 65, 67
- error codes 69
- explanation of symbols and markings 3

F

- factory-installed protocols 34
- features
 - of the printer/charger 8
- feeding the paper. *See* advancing paper 47
- flashing light on
 - Printer/Charger 8, 65, 67

G

- green LED
 - on Pod 6
- guide to otoacoustic emissions 77

I

- information about software and hardware
 - versions 17
- infrared port
 - cleaning 58
- interface
 - computer and Printer/Charger 90
 - RS-232 90
 - Screener and computer 90
- introduction 1
- items included with the system 5

L

- language
 - setting in Screener 95
- LCD contrast
 - adjusting 11

LED

- battery 8
- on the Pod
 - green, defined 6
 - green, ON 37
 - yellow, defined 6
- on the Printer/Charger
 - POWER/STATUS 8, 66, 68
- loading patient names from computer 30, 35
- low battery icon 28, 48
 - defined 48
 - remaining test time 48

M

- markings and symbols 3
- message
 - CHECK SEAL 23, 38
 - TEST SEQUENCE FULL 38
 - TESTING OAE 38
- Multi-Patient Screener setup 29

N

- names
 - entering on touchscreen 31
 - loading from computer 30, 35
 - searching for 33
- No Data message on printout 44
- NO TEST TO ERASE message 27
- NOISE test result 51
- numbers on the DATA screen defined 39

O

- otoacoustic emissions
 - about 77
 - definition 77
 - distortion product (DPOAE) 77
 - generation and detection 77
 - types of 77
- out of paper indicator 65

P

- packing list 5
- paper
 - adhesive 96
 - advancing 47
 - indicator 65
 - pink strip on edge 67
 - replacing 67
 - specifications 96
 - storing 66
 - when to replace 67
- PAPER ADVANCE button 8
- PASS 49
- patient names and ID numbers
 - character limit 32
 - entering from touchscreen 31
- patients
 - testing 37
- pink strip on paper 67
- Pod
 - attaching to Probe 16
 - attaching to Screener 16
 - green LED 6
 - Yellow LED 6
- power-down 47
- power-saving mode 27, 47
 - exiting 47
- precautions
 - maximum charging temperature for
 - battery 6
 - warm-up time and storage temperature 6
- Print button 8
- printer
 - checking 65
 - malfunction indicator 65
 - out of paper 65
- printer/charger
 - buttons and LEDs 8
 - dimensions 96
 - setup 12
 - specifications 96

- printing
 - all tests for a patient 44
 - autopairing of tests 44
 - selected tests 44
 - test pattern 66
 - test results 25
 - tests 43
- printout
 - cancelling 47
 - contents 25, 45
 - No Data message 44
- probe tip
 - attaching 58
 - cleaning 56–66
 - removing 57
- probe tones and test protocol 91
- protocols 35

Q

- Quick Check
 - cavity 62
 - running test 62
 - test failed 63
 - test passed 63

R

- rear view of printer/charger 9
- recalibration 80
- REFER 50
- REMOVED TOO SOON message 44
- removing
 - battery 60–61
 - probe tip 57
- replacing
 - battery 60
 - paper 67
 - probe tip 57
- reviewing a test 24, 42
- RS-232 interface to a computer 90
- running
 - a test 22, 24, 25, 26, 30, 37
 - Quick Check test 62

S

- Screeener
 - attaching Pod 16
 - buttons and features 8
 - dimensions 93
 - power-down 27
 - power-saving mode 27
 - setup 10, 30
 - specifications 90–94
 - turning off 28, 47
 - turning on 11
 - using 21–28, 29–48
- searching for a patient 33
- selecting
 - an eartip 14
 - patient names 33
- selecting tests
 - to download 40
 - to review 42
- sending test results to computer 39
- service and warranty information 79
- setting date and time
 - from the computer 53
 - from touchscreen 54
- setting language for Screeener 95
- setting up
 - Multi-Patient Screeener 30
 - printer/charger 12
 - Screeener 10
- specifications
 - adhesive paper 96
 - charging transformer 97
 - DIP switch functions 94
 - paper 96
 - printer/charger 96
 - printout contents 25, 45
 - Screeener 90–94
 - storage altitude 90
- starting a test 22, 24, 25, 26, 30, 37
- stopping a printout 47
- stopping a test 26, 38

- storage
 - battery removal for 61
- stored DPGrams 20
- storing
 - paper 66
 - test 24, 38
- symbols and markings 3
- T**
- Technical Service Department address 80
- test
 - erasing 26, 41
 - protocol 91
 - Quick Check 62
 - reviewing 24, 42
 - running 37
 - starting 22, 37
 - stopping 26, 38
 - storing 23, 38
 - unpaired 43
- test pattern, printing 66
- test protocols 34
- test result
 - ABORT 23, 38
- test results
 - downloading to computer 39
 - in Screener memory 42
- TEST SEQUENCE FULL message 38
- TESTING OAE message 23, 38
- testing patients 33
- tests
 - autopairing for printing 43
 - maximum per patient 33
 - printing 24, 43
 - running 22, 37
 - selecting to review 42
 - stored 20
- touchscreen
 - entering patient names 31
 - erasing characters 32
- transfer a protocol to the Screener 35
- transferring
 - patient list to the Screener 30, 35

- troubleshooting 69
- turning off the Screener 47
- turning on the Screener 11

U

- unpacking and verifying contents 5
- unpaired test
 - printing 43
- using
 - printer/charger 24
 - Screener 21–28, 29–48

V

- VER #S button 17
- version information, displaying 17

W

- warranty
 - general 79

Y

- yellow LED
 - on Pod 6

Notes

Notes

