



# Leica IC90 E User Manual

# Contents

<b>General Notes</b>	
Safety Concept	4
Symbols Used	5
Safety Instructions	6

<b>Care and Maintenance</b>	
Care and Maintenance	10

<b>The Leica IC90 E</b>	
Introduction	12
The Basics	13
Leica IC90 E: Overview	14
Camera Kit and Accessories	16

<b>Get Ready!</b>	
Assembling the Camera	

<b>Get Set!</b>	
USB Mode – Capturing and Adjusting Images Using a Computer	20
HDMI Mode – Capturing Images Without a Computer or Without a Wireless Device	22
Adjusting Settings While in SD Mode	24
Ethernet Mode – Capturing and Adjusting Images Using a Network	25

<b>The Camera Remote Control (Standalone Kit)</b>	
Optional Remote Control	27
Viewing Images and Movies With the Optional Remote Control	28
Calling up the Camera Menu	29
COLOR (Automatic White Balance)	30
COLOR (Manual White Balance)	31
EXPOSURE	32
RESOLUTION	33
SETUP CAMERA (Camera Settings)	34
SETUP USER	35
SETUP ETHERNET	36
Pairing Cameras With Remotes	38

<b>Go!</b>	
Ready! Set! Go!	40

<b>Specifications</b>	
Leica IC90 E	42
Dimensional Drawings	44

# General Notes

## Safety Concept

The Leica IC90 E is shipped with an interactive CD-ROM, where you can find all relevant user manuals. Keep it in a safe place, and readily accessible to the user. User manuals and updates are also available for you to download and print from our web site [www.leica-microsystems.com](http://www.leica-microsystems.com).

The "Safety concept" booklet contains additional safety information regarding service work, requirements and the handling of the stereo microscope, electrical and other accessories as well as general safety instructions.

You can combine individual system articles with articles from external suppliers (e.g. cold light sources, etc.). Please read the user manual and the safety requirements of the supplier.

Before installing, operating or using the instruments, read the user manuals listed above. In particular, please observe all safety instructions.

To maintain the unit in its original condition and to ensure safe operation, the user must follow the instructions and warnings contained in these user manuals.

# Symbols Used



Read and understand user manual before using this device.



## Danger due to hot surface

This symbol warns against touching hot surfaces, e.g. those of light bulbs.

## Warning of a danger



This symbol indicates especially important information that must be read and complied with. Failure to comply can cause the following:

- Hazards to personnel
- Functional disturbances or damaged instruments

## Warning of hazardous electrical voltage



This symbol indicates especially important information that, if not observed, can cause the following:

- Hazards to personnel
- Functional disturbances or damaged instruments

## Important information



This symbol indicates additional information or explanations that intend to provide clarity.

# Safety Instructions

## Safety concept

Before using your Leica IC90 E for the first time, please read the "Safety concept" booklet included with your instrument. It contains additional information on handling and care.



## Use in clean rooms

The Leica IC90 E can be used in clean rooms without any problems.

## Cleaning

- Do not use any unsuitable cleaning agents, chemicals or techniques for cleaning.
- Never use chemicals to clean colored surfaces or accessories with rubberized parts. This could damage the surfaces, and specimens could be contaminated by abraded particles.
- In most cases, we can provide special solutions on request. Some products can be modified, and we can offer other accessories for use in clean rooms.

## Servicing

- Repairs may only be carried out by Leica Microsystems-trained service technicians. Only original Leica Microsystems spare parts may be used.

## Responsibilities of person in charge of instrument

- Ensure that the Leica camera is operated, maintained and repaired by authorized and trained personnel only.

# Safety Instructions (Continued)

## Description

The individual modules fulfill the highest requirements in terms of observation and documentation with the Leica IC90 E.

## Intended use

- Refer to the "Safety concept" booklet included with your camera.

## Non-intended use

- Refer to the "Safety concept" booklet included with your camera.

The instruments and accessories described in this manual have been safety-tested and checked for possible hazards. The responsible Leica affiliate must be consulted whenever the instrument is altered, modified or used in conjunction with non-Leica components that are outside of the scope of this manual.

Unauthorized alterations to the instrument or noncompliant use shall void all rights to any warranty claims!

## Installation location

- Refer to the "Safety concept" booklet included with your camera.
- Electrical components must be placed at least 10 cm away from the wall and from flammable substances.
- Avoid large temperature fluctuations, direct sunlight and vibrations. These conditions can distort measurements and micro-graphic images.
- In warm and warm-damp climatic zones, the individual components require special care in order to prevent the build-up of fungus.

## Requirements to be met by the operator:

- Refer to the "Safety concept" booklet included with your camera.

Ensure that:

- The Leica IC90 E is operated, maintained and repaired only by authorized and trained personnel.
- All operators have read, understood and observe this User Manual, and particularly the safety regulations.

# Safety Instructions (Continued)

## Repairs, service work

- Refer to the "Safety concept" booklet included with your camera.
- Only original Leica Microsystems spare parts may be used.
- Before opening the instruments, switch off the power and unplug the power cable.
- Touching the live electric circuit can cause injury.

## Transport

- For shipping or transporting the individual modules of the Leica IC90 E, use the original packaging.
- In order to prevent damage from vibrations, disassemble all moving parts that (according to the user manual) can be assembled and disassembled by the customer and pack them separately.

## Installation in third-party products

- Refer to the "Safety concept" booklet included with your camera.

## Disposal

- Refer to the "Safety concept" booklet included with your camera.

## Legal requirements

- Refer to the "Safety concept" booklet included with your camera.

## EC Declaration of Conformity

- Refer to the "Safety concept" booklet included with your camera.

## Health risks

Workplaces equipped with stereo microscopes make it easier to examine extremely small structures, but they also impose high demands on the eyes and holding muscles of the user. Depending on the duration of uninterrupted work at such a workplace, impaired vision and problems with the musculoskeletal system may occur. Therefore, corresponding measures should be taken to reduce the strain:

- Optimal arrangement of workplace, work assignments and work flow (changing tasks frequently).
- Thorough training of the personnel, giving consideration to ergonomic and organizational aspects.



# Care and Maintenance

# Care and Maintenance

## General

- For good optical results, it is important to keep optical components clean.
- Always cover the microscope and the Leica IC90 E with the dust cover included in the delivery when the instrument is not in use.
- If an optical surface is very dirty or dusty, flush it using a syringe or clean it using a camelhair brush before attempting to wipe it off.
- Optical surfaces should be cleaned using a lint-free cloth, lens cloth or cotton swab soaked in methanol or a commercially available glass cleaner. Do not use alcohol.
- Avoid excessive use of solvents. The lint-free cloth, lens cloth or cotton swab should be soaked with solvent, but not so wet that solvent runs over the lens.

## Danger of electric shock



Risk of electric shock. Removing the cover of the Leica IC90 E camera or the stand-alone kit exposes electrically live parts which, if touched, can cause potentially fatal injuries. Have technical service carried out by a Leica Microsystems authorized dealer.

# The Leica IC90 E

# Introduction

Your Leica IC90 E is a state of the art brightfield camera with 10 megapixel image resolution. The camera can be easily connected to a variety of stereo microscopes (CMO) without additional components. There are **various ways** to connect the camera with your viewing devices:

## Ethernet mode

Use **Ethernet mode** to connect the Leica IC90 E **with your facilities' network** via Ethernet (RJ45) cable.

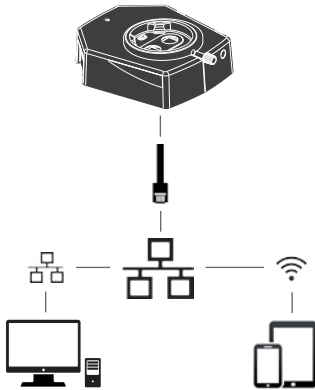

Capture images from any remote PC or MAC with access to your network (LAN).

Even mobile devices can be used if there is a WLAN-connection to the same network.

## USB mode

Use **USB mode** to **connect** the Leica IC90 E directly **via USB cable with a PC** or MAC.

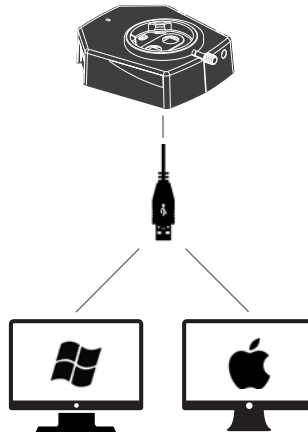

## HDMI mode

Use **HDMI mode** to connect the Leica IC90 E to a large HD-screen for a **standalone solution without computer**. You can save images directly onto SD card when operating in this mode.

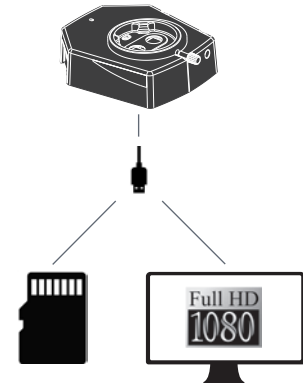

For **PC** use the **Leica Application Suite (LAS) Software (LAS 4.9 / LAS X 3.0 or higher)** and for **MAC** use **Leica Aquire (version 3.3 or higher)** to capture images. For mobile devices check the Apple App Store or Google Play for the **Leica AirLab App** from Leica Microsystems.

# The Basics

**i** Your Leica HD camera has many possibilities for various applications and conditions of use. Below are some basic concepts to help you get the most performance for your application.

**i** In order to keep your camera up to date and to benefit from newest functions you should update the camera's firmware from time to time. Detailed instructions about this topic can be found in the download section of the Leica IC90 E on our website. To check out your camera's firmware version use the information box in stand-alone mode (see section remote control) or the "About" section in the software on the computer.

## Power Leica IC90 E

Power can be provided to the camera in the following ways:

- USB power connector on the microscope stand
- External USB power supply
- USB connectors on the PC

### 1. Capture button

- Used to capture an image in HDMI mode

### 2. Mode switch

- Switch into different modes (USB mode, Ethernet mode, HDMI mode)

### 3. Mode panel

- The mode panel with the symbols for USB, Ethernet and HDMI (from top to bottom) indicates in which mode you are.
- The LEDs will flash when you change from one mode to another.



**i** Note direct connection to an HD display is possible in all modes.

# Leica IC90 E: Overview

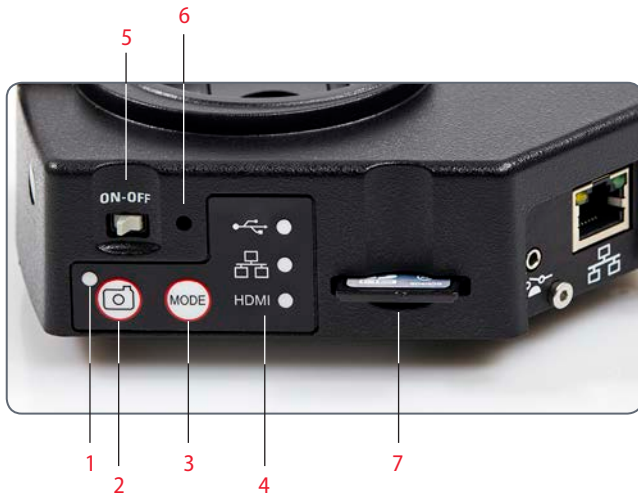

1. LED status indicator
  - Flashing when camera is starting
  - Constant green means ready
2. Capture button for SD card capture
3. Mode switch
4. Mode panel
5. Power ON/OFF switch
6. Pinhole switch
7. SD card slot

## Leica IC90 E: Overview (Continued)



1. *Socket for hand-/foot switch*
2. *Socket for Ethernet cable*
3. *Socket for the HDMI cable*
4. *Socket for the USB cable*



### **Front**

Infrared sensor: Receives the signal from the optional remote control.

# Camera Kit and Accessories

## Camera and software kit

Enables you to capture images on a PC with LAS or LAS X.

### Content

- Leica IC90 E camera
- USB cable
- CD with Leica Application Suite (LAS) Software



Article number: 12 730 521

## Standalone kit (accessory)

Enables you to connect your Leica IC90 E to a HDMI monitor and store images on a SD card. Recommended if you use the camera without a PC.

### Content

- HDMI cable
- Remote Control RC3 (art. no. 10 450 805)
- SD card
- Power supply with international connectors
- Ethernet cable



Article number: 12 730 528

## Hand-/foot switch (accessory)

Enables you to operate the camera remotely with your hand or foot. The following functions can be programmed: image capture, video, white balance, and overlay. Recommended if you need both hands to manipulate the specimen or if you work with a boom-/floorstand sensitive to vibrations.

### Content

- Hand-/foot switch



Article number: 12 730 229



# Get Ready!

# Assembling the Camera

Designed as a sandwich camera the Leica IC90 E easily fits between the microscope stand and the tube.

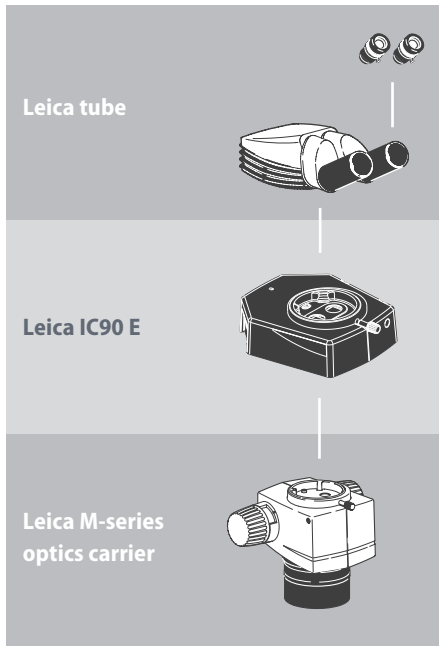

It can be mounted in four simple steps:

1. Remove the tube.



2. Place the camera onto the microscope stand.



3. Add the tube back on top of the camera.



4. Connect the camera via USB, HDMI or Ethernet to your viewing device.



# Get Set!

## USB Mode – Capturing and Adjusting Images Using a Computer

**i** 10× eyepieces have a fixed circular field of view of 18 mm or more diameter. The field of view of the IC90 E is rectangular to ensure an even field on the digital image. As a result, the image field of the camera is smaller than the object field seen through the eyepieces.

### Installing and connecting

1. Insert the provided CD into your computer, and follow the instructions to load the software.

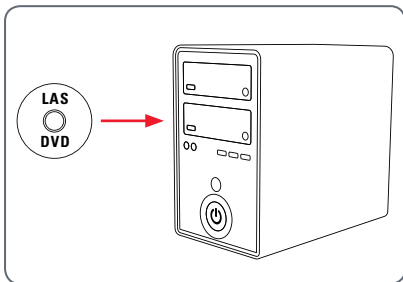

2. Insert the provided USB cable into the camera's USB port, and attach the other end of the cable to a USB 2.0 port of your computer.



3. Turn on the camera using the ON/OFF switch.



4. The status light will blink green. Wait until the status light stops flashing and one of the mode panel buttons turns green. This may take approximately 30 seconds.

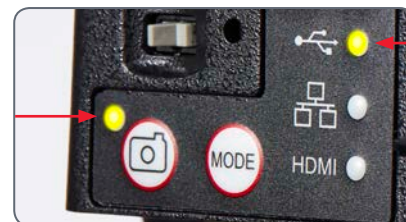

## USB Mode – Capturing and Adjusting Images Using a Computer (Continued)

5. If a mode other than USB is lit green, press the mode switch and wait until both the status LED and the USB mode panel stop flashing.



6. You are ready to launch the Leica software. Follow the software instructions to adjust and capture an image.
7. While in USB mode, you can connect the provided HDMI cable from the camera to an HD monitor or HD projector to share the image.

 Note the image resolution on the HD projector or monitor is limited to the live image resolution setting in the software. If an aspect ratio of 4:3 is chosen in the software, the image on the HDMI monitor will be distorted as shown below. This is due to the fact that the HDMI monitor interprets every signal as having an 16:9 aspect ratio.



*4:3 aspect ratio*



*4:3 aspect ratio image on a screen set to an aspect ratio of 16:9*

# HDMI Mode – Capturing Images Without a Computer or Without a Wireless Device

 In order to use this mode, you need a SD card with enough free memory. The SC card is part of the standalone kit. If the SD card is full, you will not be able to capture any images – a corresponding message will be shown.

## Attaching the power cable

1. Be sure the camera is connected to a power source – see power source section on [page 43](#).
2. Click the switch labelled ON/OFF into the ON position.



3. The status light will blink green. Wait until the status light stopped flashing and one of the mode button's is also green. This may take approximately 30 seconds.



4. If a mode other than HDMI is lit green, press the mode switch and wait until both the status LED and the LED next to the HDMI mode panel stop flashing.



# HDMI Mode – Capturing Images Without a Computer or Without a Wireless Device (Continued)

5. Insert the SD memory card into the slot on the side of the Leica IC90 E until the card clicks into place. The Leica IC90 E is now ready to capture images onto the SD memory card.



## Capturing an image



It is critical to properly set the microscope eyepieces' diopters to ensure that the images on the SD memory card are in focus when the image is in focus through the microscope's eyepieces. Refer to the microscope's user manual for proper diopter setting. Focus the microscope at high magnification, then change to the magnification at which you wish

to capture the image. Do not refocus the microscope. You can also use the HDMI output and an HD display (not provided) as a focusing aid.

6. To capture an image onto SD card, press the capture button, located on the side of the Leica IC90 E camera.



- You will hear a beep to acknowledge the button was pressed.
- The status LED flashes green while the image is being captured.

- You will hear another beep when the Leica IC90 E has completed capturing the image and the status LED will return to steady green.

The image is now saved on the SD card. Images which are on the SD card can be viewed using the optional remote control. See "Camera Remote Control" on [page 26](#).

7. While in HDMI mode, you can connect the provided HDMI cable from the camera to an HD monitor or HD projector to share the image.



## Adjusting Settings While in SD Mode

### Setting a new white balance

 Make sure that there is no sample in the beam path and that a standard illumination is available when you reset the camera.

Press and hold the capture button for 5 seconds. Wait for the beep. A new white balance is set.



### Return to factory settings

Press and hold the pinhole switch for 5 seconds. Wait for the beep. The camera will now reset to factory settings.



 It is recommended to set a new white balance each time you change the type or color temperature of the illumination. This is especially needed when you work with halogen light which can be turned from low intensity yellow to a high intensity blue light. The new white balance setting will generate a neutral background for both illuminations.



## Ethernet Mode – Capturing and Adjusting Images Using a Network

1. Connect one end of an Ethernet cable (part of the stand alone kit) to the camera and the other end of the cable to the Ethernet connection in your facility.



2. Be sure the camera is connected to a power source – see power source section on [page 43](#).
3. Click the switch labelled ON/OFF into the ON position.



4. The status light will blink green. Wait until the status light stopped flashing and one of the mode button's is also green. This may take approximately 30 seconds.



5. If a mode button other than Ethernet mode is lit green, then press the mode button and wait until both the status LED and the Ethernet LED mode button stopped flashing.



6. Follow the directions of your network compatible device to connect to your facilities network and select the camera.
7. Open the appropriate app on your mobile device or appropriate software on your PC for viewing, capturing, and adjusting the camera image.

# The Camera Remote Control (Standalone Kit)



The remote control is designed to work only when the camera is in HDMI mode and when the camera is used in combination with an HD display.

The only function which works in any mode is the "Info" function which shows details about the camera.

## Optional Remote Control



The remote control only works in HDMI mode. Aside from the  button, it will display information about the camera on a HD display in every mode. The remote must be pointed at the IR receiver of the camera without obstructions.







1. Start/stop video recording
2. Save still image to SD card
3. Stop/continue live image, pause/play movie clip
4. View files on SD card
5. Move to previous image on SD card
6. Move to next image on SD card
7. Brightness adjustment up or down
8. Pairing button
9. Show/hide information box
10. White balance set button
11. Call up the camera menu
12. Arrow keys for navigation
13. OK to confirm

# Viewing Images and Movies With the Optional Remote Control

 If you have purchased the optional remote, the Leica HD camera shows images and movie clips directly on an HD monitor.

1. Thumbnail view  (first press)

- up/down/left/right ► select thumbnail
-  Show image in full screen or playback movie clip
- next image  / previous  image
-  ► Play movie clip
- left/right ► fast forward / rewind

2. To return to live view press .

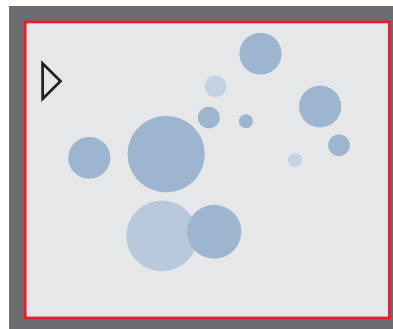

*Playback / fullscreen view*

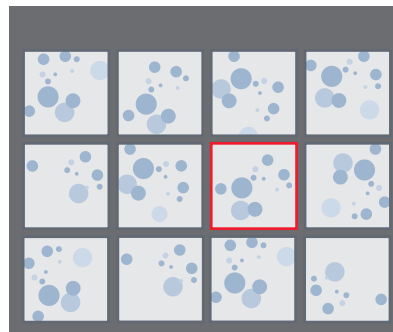







*Thumbnail view*

# Calling up the Camera Menu

 The remote control can only work when the camera is in HDMI mode.





## Opening and closing the camera menu

1. Point the remote control towards the camera.
2. Press the  key on the remote control to show the camera menus on the monitor.
3. Press the , ,  and  buttons to select a menu item.
4. Press the  button to confirm a menu item.
5. Press the  button again to hide the camera menus.



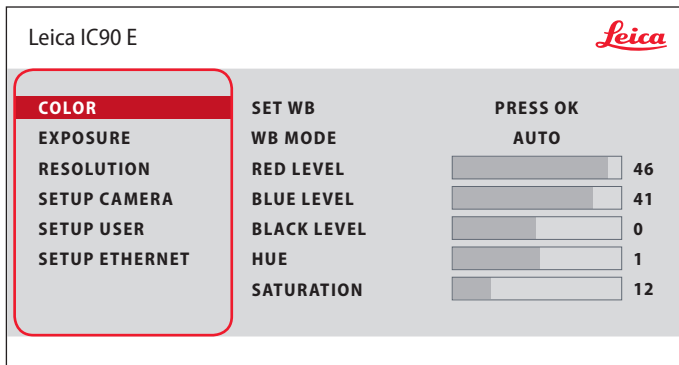

## COLOR (Automatic White Balance)



 The "COLOR" function makes it possible to adapt the camera chip to the ambient light so that color-neutral images can be acquired.

### Enabling automatic white balance



1. Press the  button on the remote control.
2. Call up the "COLOR" entry.
3. Set the value for "WB MODE" to "AUTO".
4. Press the  button to exit the menu.

 The values for "RED" and "BLUE" cannot be adjusted if the "WB MODE" setting is set to "AUTO".

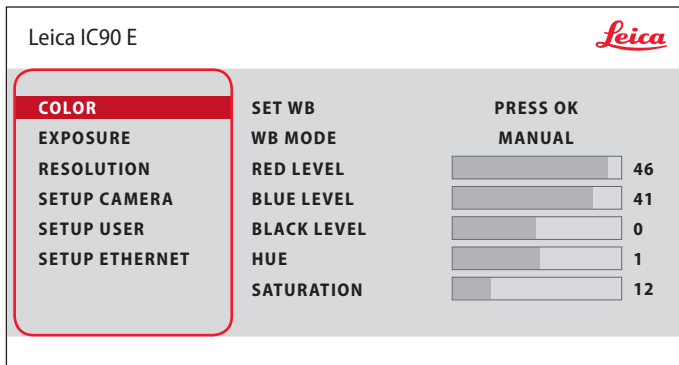
## COLOR (Manual White Balance)



### Adjusting the white balance manually (recommended)

1. Move the specimen out of the field of view so that only the illumination is seen.
2. Press the  button on the remote control.
3. Call up the "COLOR" entry.
4. Set the "WB MODE" to "MANUAL".
5. If necessary, correct the values for "RED" and "BLUE" until the image shows a uniform gray area.
6. Press the  button to exit the menu.

 The "COLOR" function makes it possible to adapt the camera chip to the ambient light so that color-neutral images can be acquired.

# EXPOSURE

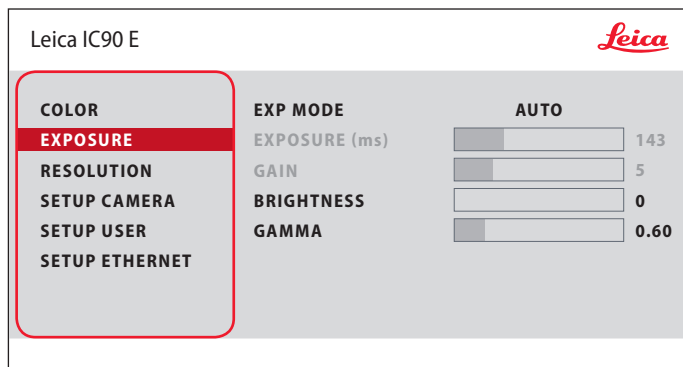

## Automatic exposure

1. Press the  button on the remote control.
2. Call up the command for automatic exposure (see diagram at the left).
3. Set the value for "EXP MODE" to "AUTO".
4. Correct the values for "BRIGHTNESS" and "GAMMA" until you obtain the desired results for the image.

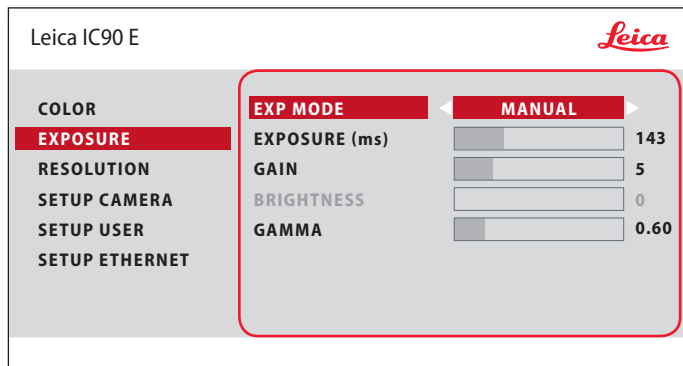

## Manual exposure

1. Press the  button on the remote control.
2. Call up the command for manual exposure (see diagram at the left).
3. Set the value for "EXP MODE" to "MANUAL".
4. Correct the values for "EXPOSURE (ms)", "GAIN" and "GAMMA" until you obtain the desired results for the image.



# RESOLUTION

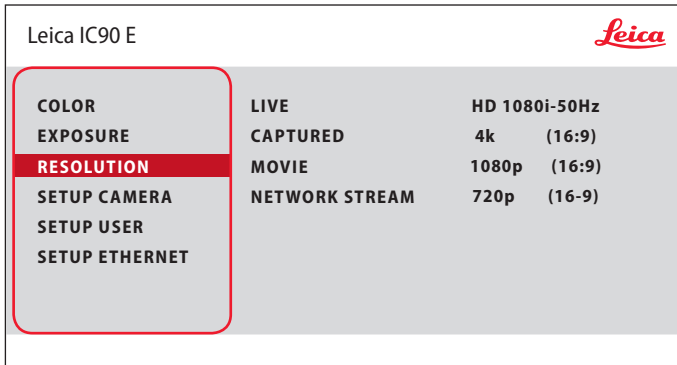

## **LIVE (resolution of the live image)**

Defines the resolution of the live image.

## **CAPTURED (resolution of the captured image)**

Defines the resolution of the captured image on the SD card.

## **MOVIE (resolution of videos)**

Indicates the resolution of the captured videos on the SD card.

## **NETWORK STREAM**

Defines the resolution of the image transmitted over the Ethernet port.



The "RESOLUTION" menu enables you to define the resolution for the live image, still image capture and video capture individually. This provides optimum results in every situation.

# SETUP CAMERA (Camera Settings)

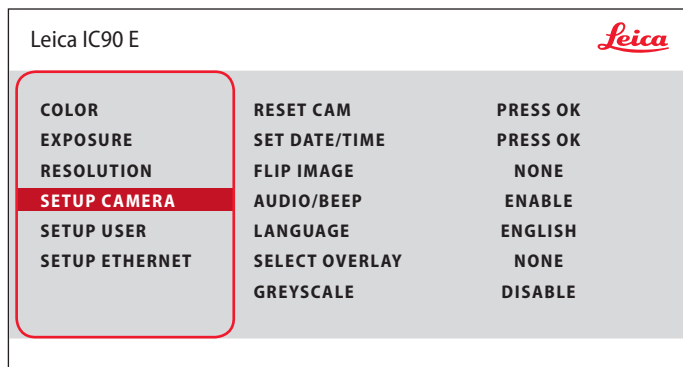

 The camera settings enable you to control internal parameters such as the date or time, reset the camera, etc.

## RESET CAMERA

This command resets the camera to the factory settings. All user information (such as white balance, resolution etc.) is reset.

## SET DATE TIME

This command sets the date and time as well as the format for displaying them. The following formats are available for selection: YYMMDD – DDMMYY – MMDDYY

## FLIP IMAGE

Select this to view your images horizontal, vertical, or horizontal and vertical.

## AUDIO/BEEP

You can decide to have a tone from the camera for some functions.

## LANGUAGE

Select the language of the On Screen Display.

## SELECTING IMAGE OVERLAYS (SELECT OVERLAY)

Press ◀ ▶ to select another overlay. Press  to activate the selected overlay and leave the menu.

 If you want to quickly display other overlays, press when the live image is displayed ▼ ▲ to show the next or previous respective overlay.

 The firmware of the camera can be updated. For detailed instructions please consult the download section of this camera on the webpage of Leica Microsystems.

## GREYSCALE

Allows you to remove the color information in the displayed and saved image.

# SETUP USER

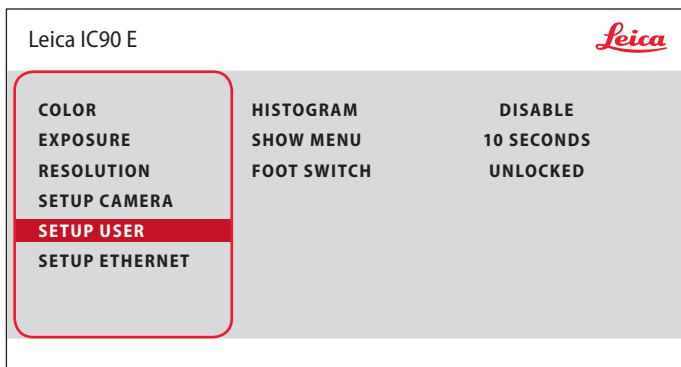

## HISTOGRAM

Enables the display of a histogram as a picture in picture.

## SHOW MENU

Changes the display time of the menu bar. You can select between 10 seconds and infinity. The menu can still be deactivated if you press the camera menu button.

## FOOT SWITCH

Allows you to select the function that should be triggered through the hand-/foot switch. The following function can be programmed: image capture, video, white balance, and overlay.



The camera settings enable you to control internal parameters such as the date or time, reset the camera, etc.

# SETUP ETHERNET

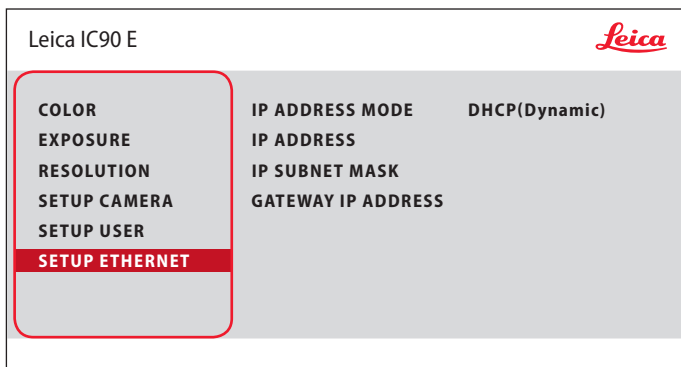



## IP ADDRESS

You can choose if you want the IP address to be set automatically by your network (Dynamic) or you can manually enter an IP address using the onscreen keyboard (Static).

If you select "STATIC" for the IP address, you can select from the following options using the onscreen keyboard:

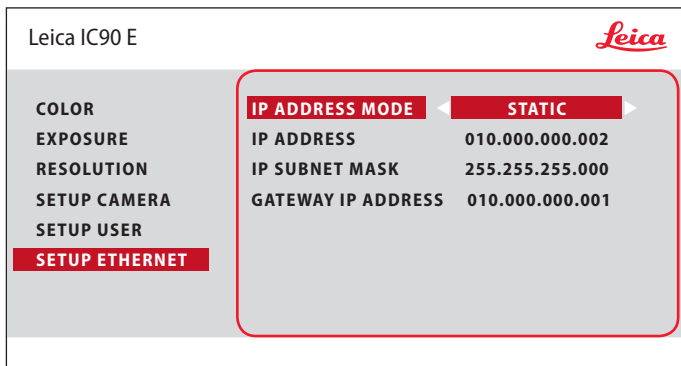
- IP address
- IP subnet mask
- Gateway IP address



 This menu allows you to customize parameters relevant to working in Ethernet mode. Consult with your local IT expert for information relating to your local network.

# SETUP ETHERNET (Continued)

## Camera configuration

1. Open camera configuration panel on your PC.
2. In the top right corner find the Ethernet setting section.
3. Find the dropdown menu labelled "IP ADDRESS MODE" and select "STATIC".
4. Enter the IP address in the relevant boxes ("IP ADDRESS", "IP SUBNET MASK", "GATEWAY IP ADDRESS").
5. Camera should be recognized.

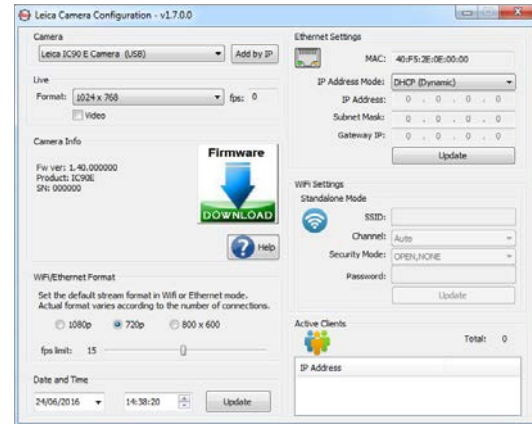



# Pairing Cameras With Remotes

## Pairing

 The Leica IC90 E and the remote control can be paired and then only respond to each other. This can be helpful when using multiple cameras and remote controls.

1. Press the  button to start or end the process.

 In order to achieve successful pairing and avoid pairing by mistake, the second step must be performed within 4 seconds.

 If a "timeout" is displayed after 4 seconds, press the "Pair" button again to start the process.

2. Press and hold the button on your remote control representing the channel that you want to assign to the connection (see image to the right, channel selection) until a corresponding confirmation is displayed on the HD monitor. All of the buttons except the  button can be used for this.

3. The microscope only responds to the remote control commands from the remote control used for the pairing.

## Resetting to factory setting

1. Press the button  to start the process.
2. Press the button  until a corresponding confirmation is displayed on the HD monitor.



**Go!**

# Ready! Set! Go!

Now all you need to do is properly set up your microscope, capture your images, and enjoy!



# Specifications

Due to the technology of the camera, the specifications are changing regularly. Please visit our website [www.leica-microsystems.com](http://www.leica-microsystems.com) for the latest brochure downloads to find the up to date specifications.

# Leica IC90 E

## Leica IC90 E digital camera

- Weight 600 g (camera only)
- Exposure time 2 ms to 500 ms
- Live image on computer screen up to 35 fps (1,024 × 768 pixels)
- Live image on HDMI screen up to 38 fps (1,280 × 760 pixels)
- Live image on HDMI screen up to 20 fps (1,920 × 1,080 pixels)
- Full-screen image capture 3,648 × 2,736, 10 megapixels
- Sensor size: 6.44 mm × 4.6 mm
- Pixel size: 1.67 μm × 1.67 μm

## Sensor

- Sensor type: CMOS
- Gain 1 × – 20 ×
- Color depth 24-bit
- File formats JPEG / MP4

## Software

Operating systems: Windows 7 (LAS 4.9), Windows 10 (LAS X 3.0), MacOS (Leica Acquire), iOS & Android (AirLab)

## Mechanical and optical interfaces

- Fits between tube and optics carrier via standard Leica dovetail
- Light distribution optical 50 % / camera 50 %
- Internal video magnification 0.5 ×

## Electronic interfaces

- Compatibility: USB 2.0
- Pinhole switch for toggling between HDMI resolutions
- LED for power on and status indication
- Integrated SD slot (Secure Digital)
- Capture switch for image acquisition
- Mode switch for selecting operating modes
- Mode panel for showing the operating mode

# Leica IC90 E (Continued)

## Power supply voltage and frequency

- Input: 5 V DC / 800 mA
- Power consumption: 4 W
- When using the stand-alone kit: 100–240 V, 50/60 Hz

## Ambient conditions

- Elevation up to 2,000 m
- For use in enclosed rooms only
- Operating Temperature: 10 °C to 40 °C (50 °F to 104 °F)
- Storage Temperature: -20 °C to 55 °C (-4 °F to 131 °F)
- Installation category II (overvoltage category)
- Pollution degree 2
- Relative humidity for operation/storage: 10 % to 90 % (noncondensing)
- Altitude operating: 0 m to 2,000 m (0 ft to 6,561 ft)
- Altitude non-operating: 0 m to 10,668 m (0 ft to 35,000 ft)

## Other

- Power supply via USB 2.0
- External power supply optional
- Minimum computer configuration:  
Please consult the software used!
- 24-bit graphics, 1,024 × 768, CD-ROM drive

## Standards

- According to CE declaration conformity

# Dimensional Drawings

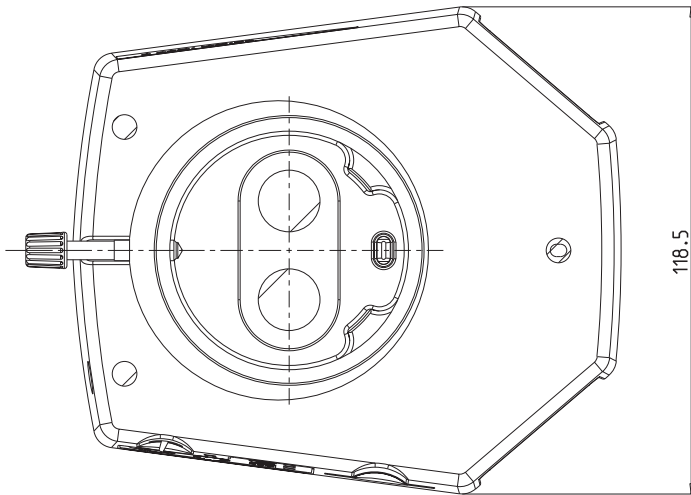
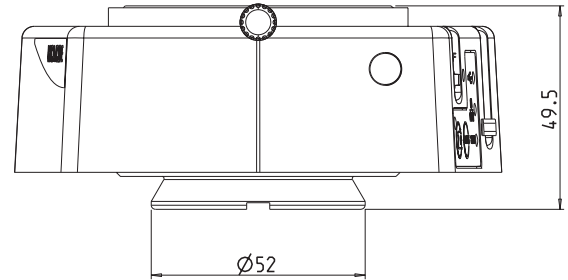
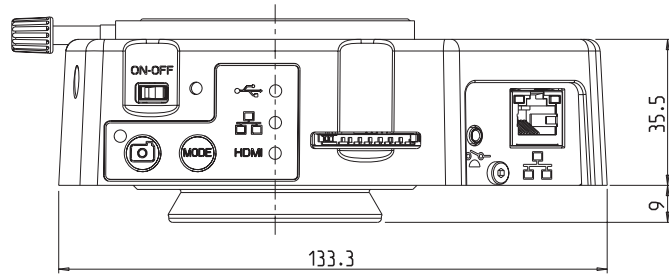

07/16 · Order no.: 101DC25060EN · © 2016 by Leica Microsystems GmbH.  
Subject to modifications. LEICA and the Leica Logo are registered trademarks of Leica Microsystems IR GmbH.



Leica Microsystems (Schweiz) AG · Max-Schmidheiny-Strasse 201 · 9435 Heerbrugg, Switzerland  
T +41 71 726 34 34 · F +41 71 726 34 44

[www.leica-microsystems.com](http://www.leica-microsystems.com)

CONNECT  
WITH US!

