

Models 5360 and 5365 Four Channel Analog to Digital Video Converters and Embedders Data Pack

ENSEMBLE
DESIGNS

Revision 1.1 SW v2.2.1

This data pack provides detailed installation, configuration and operation information for both the **5360 and 5365 Four Channel Analog to Digital Video Converters and Embedders** module as part of the Avenue Signal Integration System.

The module information in this data pack is organized into the following sections:

- 5360 and 5365 Overview
- Applications
- Installation
- Cabling
- Module Configuration and Control
 - Front Panel Controls and Indicators
 - Avenue PC Remote Control
 - Avenue Touch Screen Remote Control
- Troubleshooting
- Software Updating
- Warranty and Factory Service
- Specifications

5360 AND 5365 OVERVIEW

The Avenue 5360 and 5365 modules convert four channels of analog video and audio to four streams of SD SDI with embedded audio. Use these modules with routers, switchers, remote trucks or any application that requires many channels of high quality video and conversion. This is a perfect solution for satellite installations that need to feed a large number of analog signals from IRDs into a monitor wall. Refer to the block diagram on the following page.

12 bit analog to digital conversion, digital decoding of the composite input, and adaptive comb filtering ensure superior output signals. Proc amp functions allow adjustment of video, chroma, setup and hue.

Analog audio inputs are digitized at 24 bits of resolution and then embedded into the associated video signal.

5360 (but not the 5365) also has a genlock reference input and a TBC/Frame Sync for each of the four conversion channels. The 5360 can accept noisy asynchronous inputs and is well suited for feeds from remote trucks and satellite receivers. Additionally, the 5360's outputs are independently timeable.

Like all Avenue modules, every function and parameter of the 5360 and 5365 can be controlled from an Avenue Touch Screen, Express Control Panel, or the Avenue PC Control Application. The Express Control Panel works very nicely for live shading with its dedicated video, chroma, pedestal, and hue knobs. The continuous rotation velocity sensitive knobs are responsive and dependable.

5360 and 5365 module memory registers can be used to save the complete configuration of the modules, making it easy to change instantly between different configurations.

Modules at software version 2.2.0 or later support SNMP (Simple Network Management Protocol) monitoring. For each applicable signal processing module, module, signal, and reference status are reported. For complete details on using SNMP monitoring, refer to the **Avenue System Overview** section in the manual that accompanies each frame.

Models 5360 and 5365 Four Channel Analog to Digital Video Converters and Embedders

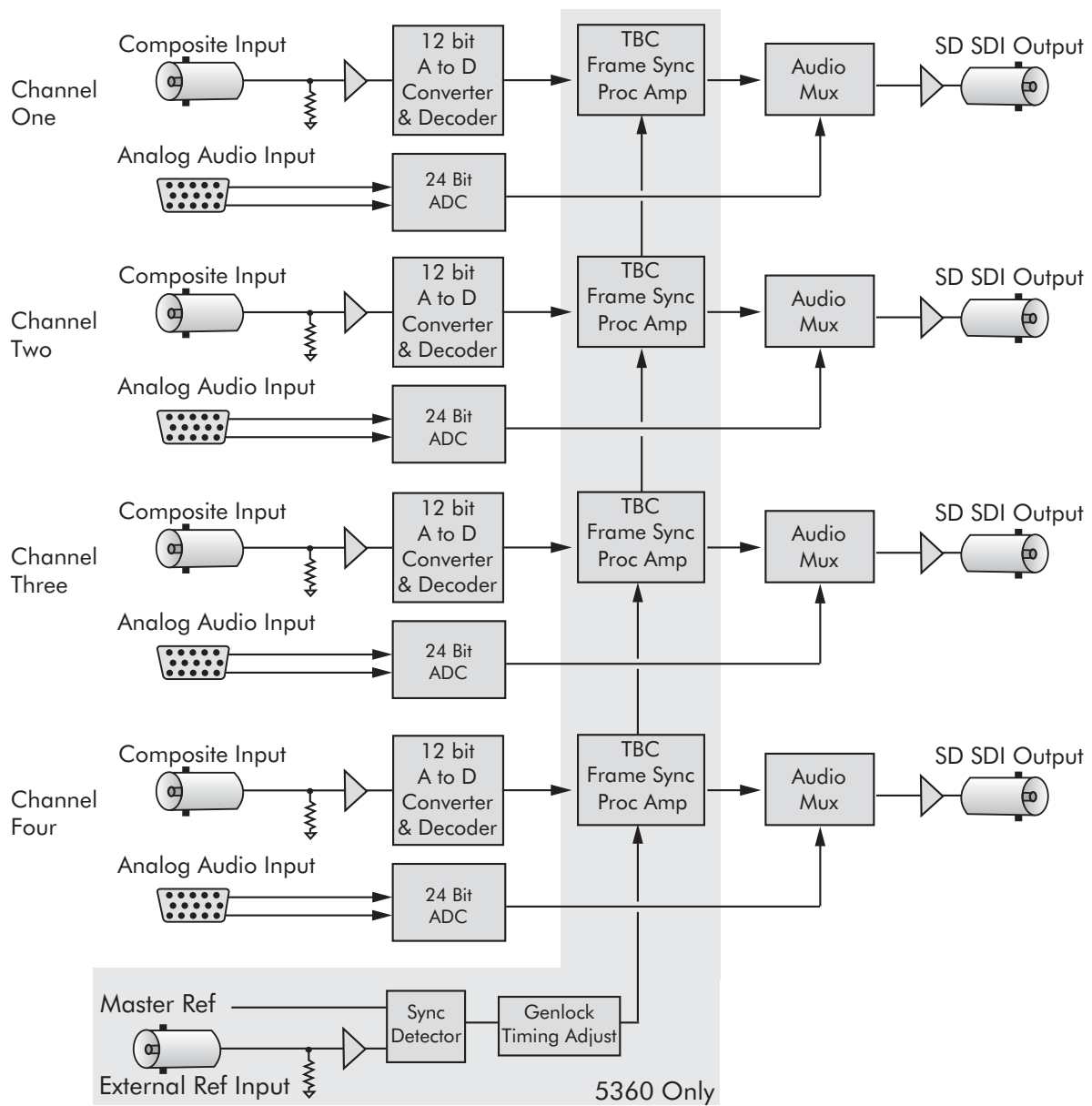

**Models 5360 and 5365 Four Channel Analog to Digital Video Converters and Embedders
Functional Block Diagram.**

Note: The shaded area indicates functionality unique to the 5360.

APPLICATIONS

This section provides a typical application for using the 5360 Video ADC/TBC module.

Satellite Reception

As illustrated in the block diagram below, the 5360 will accept up to four analog inputs, convert them to serial digital, then lock the signals to the house reference with full timing capability.

This type of application for converting noisy asynchronous satellite receiver inputs is ideal for the 5360. Each channel can be adjusted independently for video processing and timed to the house reference to feed a digital facility router.

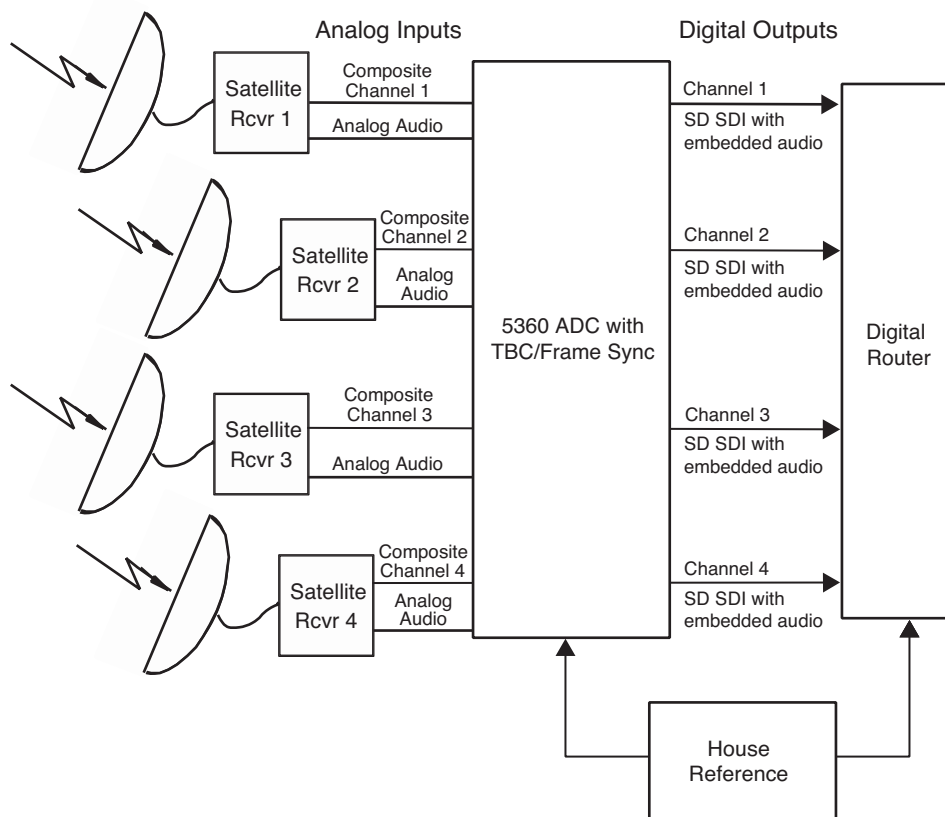

Satellite Application Block Diagram

INSTALLATION

5360 and 5365 ADC Modules

Plug the 5360 or 5365 modules into any one of the slots in the 1 RU or 3 RU frame and install the plastic overlay provided onto the corresponding group of rear BNC connectors associated with the module location. Note that the plastic overlay has an optional adhesive backing for securing it to the frame. Use of the adhesive backing is only necessary if you would like the location to be permanent and is not recommended if you need to change module locations. These modules may be hot-swapped (inserted or removed) without powering down or disturbing performance of the other modules in the system.

CABLING

Refer to the 3 RU and 1 RU backplane diagrams of the module on the following page for cabling instructions. Note that unless stated otherwise, the 1 RU cabling explanations are identical to those given in the 3 RU diagram.

3 RU Backplane

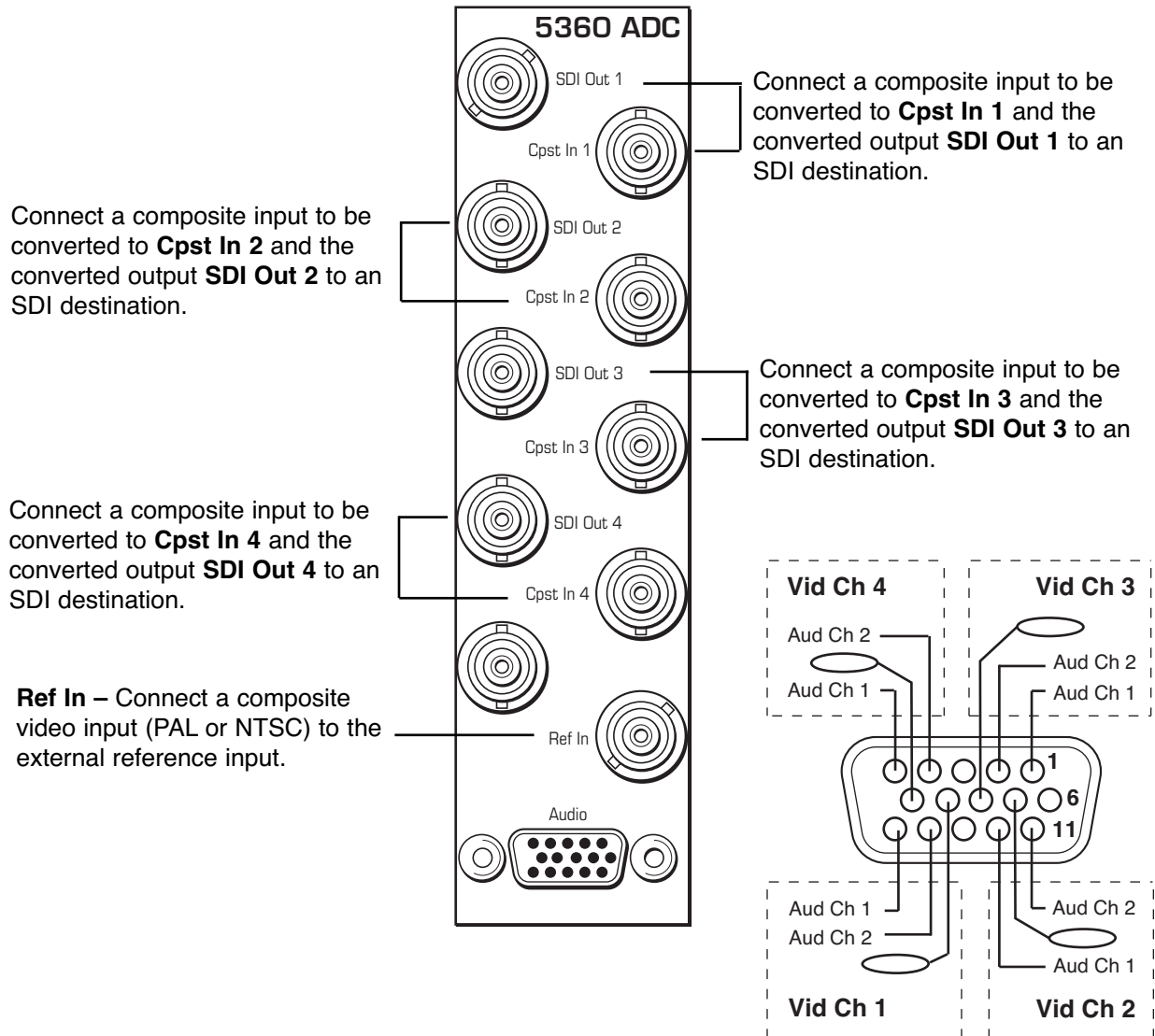

1 RU Backplane

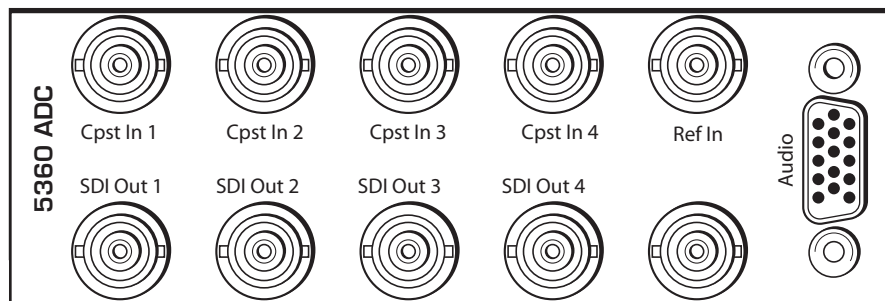

3 RU Backplane

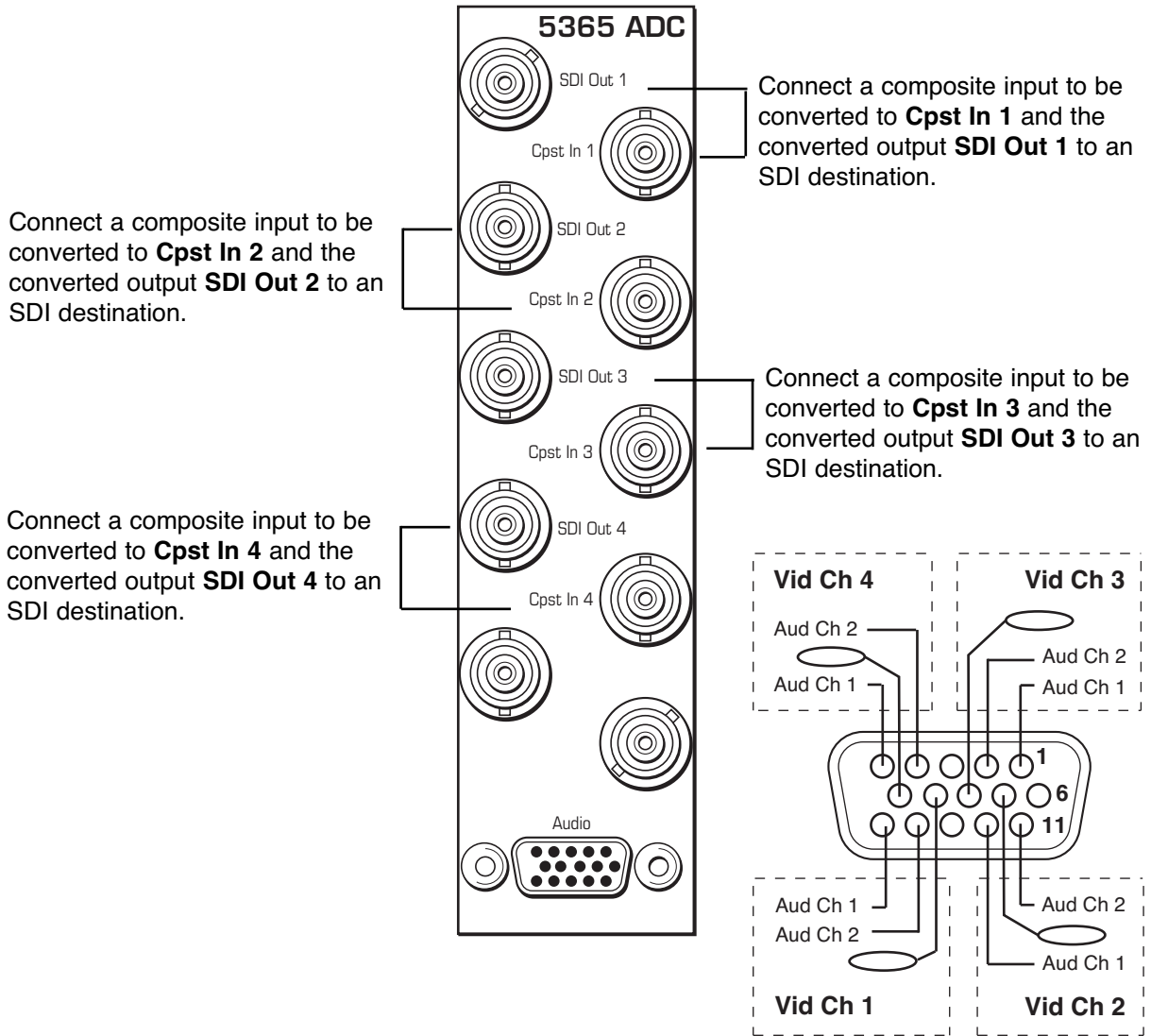

1 RU Backplane

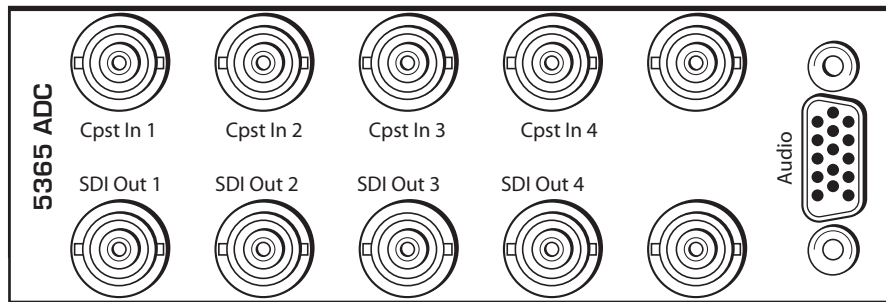

MODULE CONFIGURATION AND CONTROL

The configuration parameters for each Avenue module must be selected after installation. This can be done remotely using one of the Avenue remote control options or locally using the module front panel controls. Each module has a **REMOTE/LOCAL** switch on the front edge of the circuit board which must first be set to the desired control mode.

The configuration parameter choices for the module will differ between **Remote** and **Local** modes. In **Remote** mode, the choices are made through software and allow more selections. The **5360 and 5365 Parameter Tables** later in this section summarize and compare the various configuration parameters that can be set remotely or locally and the default/factory settings. They also provide the default User Levels for each control. These levels can be changed using the Avenue PC application.

If you are not using a remote control option, the module parameters must be configured from the front panel switches. Parameters that have no front panel control will be set to a default value. The **Local** switches are illustrated in the **Front Panel Controls and Indicators** section following the **5360 and 5365 Parameter Tables**.

Avenue module parameters can be configured and controlled remotely from one or both of the remote control options, the Avenue Touch Screen or the Avenue PC Application. Once the module parameters have been set remotely, the information is stored on the module CPU. This allows the module to be moved to a different cell in the frame at your discretion without losing the stored information. Remote configuration will override whatever the switch settings are on the front edge of the module.

For setting the parameters remotely using the Avenue PC option, refer to the **Avenue PC Remote Configuration** section of this document.

For setting the parameters remotely using the Avenue Touch Screen option, refer to the **Avenue Touch Screen Remote Configuration** section of this document following Avenue PC.

Express Panel operation is described in the data pack that accompanies the control panel option.

5360 Parameter Table

CONTROL	LOCAL	REMOTE	FACTORY DEFAULT	DEFAULT USER LEVEL
Ch 1-4 Blanking	Wide	Narrow (PAL Lines 1-6< NTSC Lines 1-9) Wide (PAL Lines 1-22< NTSC Lines 1-20)	Wide	Admin
Ch 1-4 Reference Source	Ext Ref	Ext Ref Master Ref Video In Ref	Ext Ref	Admin
Ch 1-4 Setup Removal	Off	Off On	Off	Admin
Ch 1-4 Signal Mute	No Muting	No Muting Mutes on Noise Freezes on Noise	No Muting	Level 1
Ch 1-4 Test Pattern	Off	Off On	Off	Level 1
Ch 1-4 Comb Filter	3 Line	3 Line 5 Line	3 Line	Level 1
Ch 1-4 Gain	100%	0 – 150%	100%	Admin
Ch 1-4 Chroma	100%	0 – 150%	100%	Admin
Ch 1-4 Pedestal	0 IRE	+/- 30 IRE	0 IRE	Admin
Ch 1-4 Hue	0 degrees	+/- 180 degrees	0 degrees	Admin
Ch 1-4 TBC/Frame Sync	Sw 1:TBC 1 Sw 2:TBC 2 Sw 3:TBC 3 Sw 4:TBC 4	Off On	On	Admin
Ch 1-4 HorizontalTiming	0 clocks	+/- 1700 clocks	0 clocks	Admin
Ch 1-4 Vertical Timing	0 lines	+/- 620 lines	0 lines	Admin
Ch 1-4 Audio Gain	0 dB	-700 to 120 dB	0 dB	Admin
Ch 1-4 Embedding	Group 1	Off, Group 1, Group 2, Group 3, Group 4	Group 1	Admin
Ch 1-4 Anlg Ref Level	+4 dB	-10 dB, -6 dB, -4 dB, 0 dB, +4 dB	+4 dB	Admin
Reference Source	Ext Ref	Ext Ref Master Ref Video In Ref	Ext Ref	Admin
Dig Ref Level	-20 dBFS	-18 dBFS, -20 dBFS	-20 dBFS	Admin

5365 Parameter Table

CONTROL	LOCAL	REMOTE	FACTORY DEFAULT	DEFAULT USER LEVEL
Ch 1-4 Blanking	Wide	Narrow (PAL Lines 1-6< NTSC Lines 1-9) Wide (PAL Lines 1-22< NTSC Lines 1-20)	Wide	Admin
Ch 1-4 Setup Removal	Off	Off On	Off	Admin
Ch 1-4 Signal Mute	No Muting	No Muting Mutes on Noise Freezes on Noise	No Muting	Level 1
Ch 1-4 Test Pattern	Off	Off On	Off	Level 1
Ch 1-4 Comb Filter	3 Line	3 Line 5 Line	3 Line	Level 1
Ch 1-4 Gain	100%	0 – 150%	100%	Admin
Ch 1-4 Chroma	100%	0 – 150%	100%	Admin
Ch 1-4 Pedestal	0 IRE	+/- 30 IRE	0 IRE	Admin
Ch 1-4 Hue	0 degrees	+/- 180 degrees	0 degrees	Admin
Ch 1-4 Horizontal Timing	0 clocks	+/- 1700 clocks	0 clocks	Admin
Ch 1-4 Vertical Timing	0 lines	+/- 620 lines	0 lines	Admin
Ch 1-4 Audio Gain	0 dB	-700 to 120 dB	0 dB	Admin
Ch 1-4 Audio Embedding	Group 1	Off, Group 1, Group 2, Group 3, Group 4	Group 1	Admin
Ch 1-4 Anlg Ref Level	+4 dB	-10 dB, -6 dB, -4 dB, 0 dB, +4 dB	+4 dB	Admin
Dig Ref Level	-20 dBFS	-18 dBFS, -20 dBFS	-20 dBFS	Admin

Front Panel Controls and Indicators

Each front edge indicators and switch settings are shown in the diagrams below:

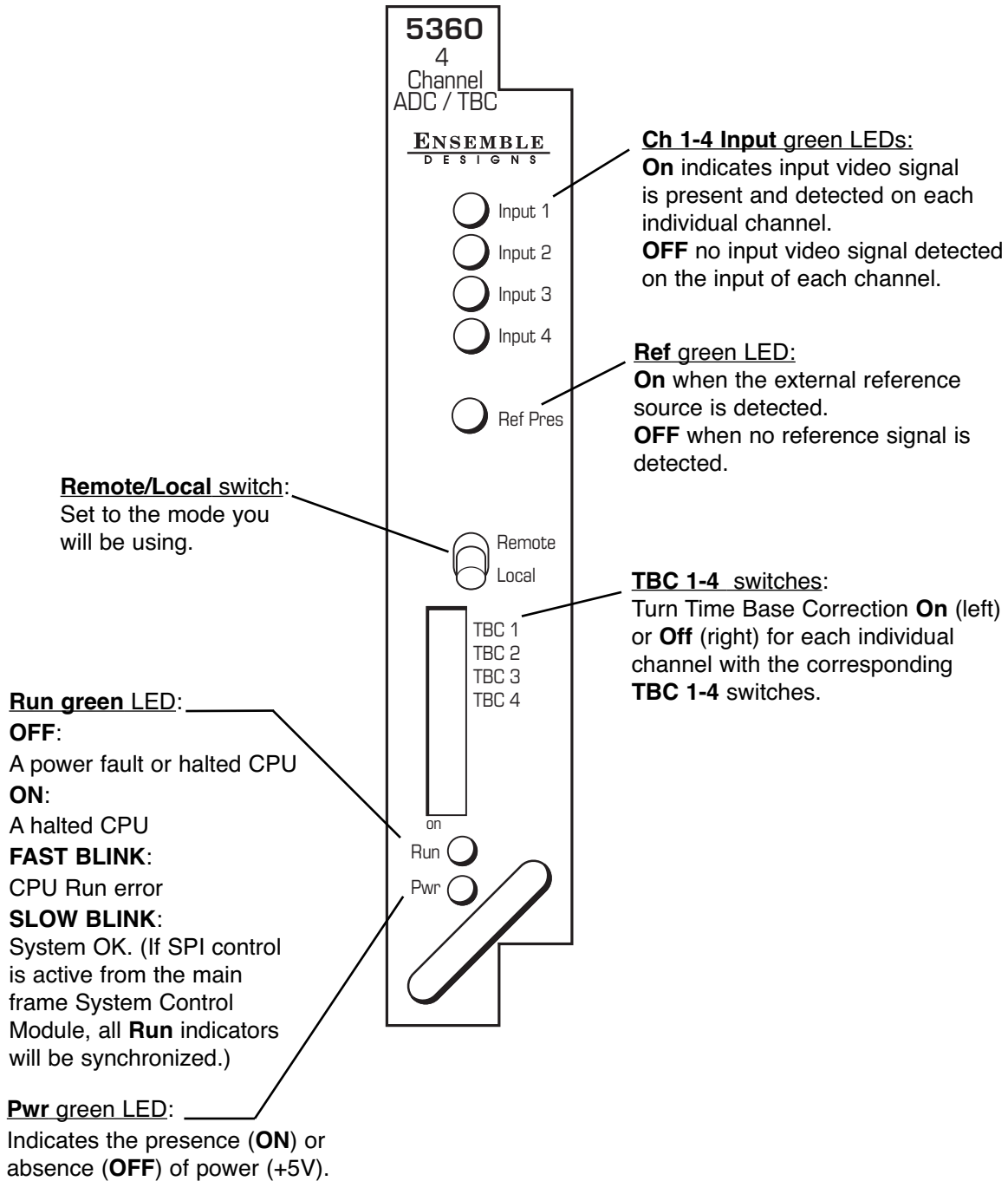

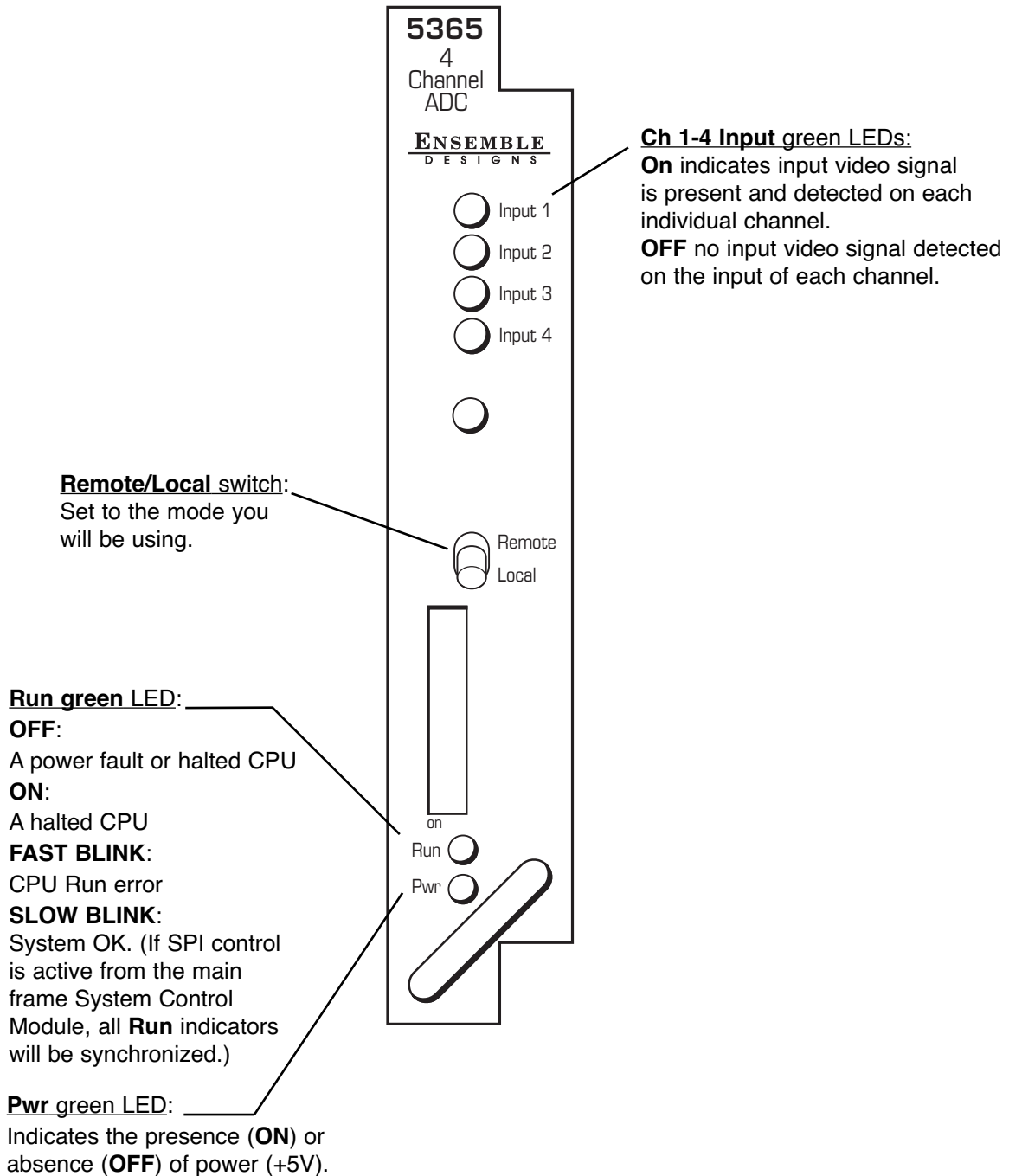

Avenue PC Remote Configuration

The Avenue PC remote control menus for these module are illustrated and explained below. Refer to the **5360 and 5365 Parameter Tables** for a summary of available parameters that can be set remotely through the menus illustrated.

Parameter fields that are grayed out can indicate one of the following conditions:

- An option is not installed.
- The function is not active.
- The module is locked.
- The User Level set with Avenue PC is not accessible from the current User Level.

5360 and 5365 Avenue PC Menus

The **Config 1** menu example shown below shows the configuration parameters available for each individual channel 1 – 4 in their respective Config menus.

- **Blanking** – use this control to set the blanking for the channel as **Narrow** (lines 1-9 are blanked in NTSC, lines 1-6 in PAL) or **Wide** (lines 1-20 in NTSC, lines 1-22 in PAL).
- **Setup Removal** – use this control to turn setup removal **On** or **Off** depending on the requirement of the input signal.
- **Signal Mute** – set the action of the output when the input signal is lost. Available values are **No Muting**, **Mutes on Noise**, **Freeze on Noise**.
- **Test Pattern** – turn a Color Bars test pattern on or off. Available values are **Off**, **Bars**, **Black**.
- **Comb Mode** – set the comb mode for **3 Line** (best for video with motion) or **5 Line** decoding.

Status reporting is provided for the following conditions:

- **Input** – reports the input status as **No Input**, **525 Lock**, or **625 Lock**.

Repeat the configuration for each of the four input channels with their respective **Config** menus.

TBC 2	TBC 3	TBC 4	Audio 1	Audio 2	Audio 3	Audio 4	Config All	Memory
Config 1	Config 2	Config 3	Config 4	Proc 1	Proc 2	Proc 3	Proc 4	TBC 1
Input 525 Lock			Blanking Narrow			Setup Removal On		
Signal Mute Mutes on Noise			Test Pattern Off			Comb Mode 5 Line		

The **Proc 2** menu shown below gives an example of the adjustable video processing parameters for each channel in their respective Proc 1 – 4 menus:

- **Gain** – adjust the percentage of overall gain (luminance and chrominance). Available value range: **0 – 150%**.
- **Chroma** – adjust the percentage of chroma amplitude. Available value range: **0 – 150%**.
- **Pedestal** – adjust the pedestal (black) level of the signal in IRE. Available value range: **-30 – 30 IRE**.
- **Hue** – adjust the hue of the signal **± 180 degrees**.

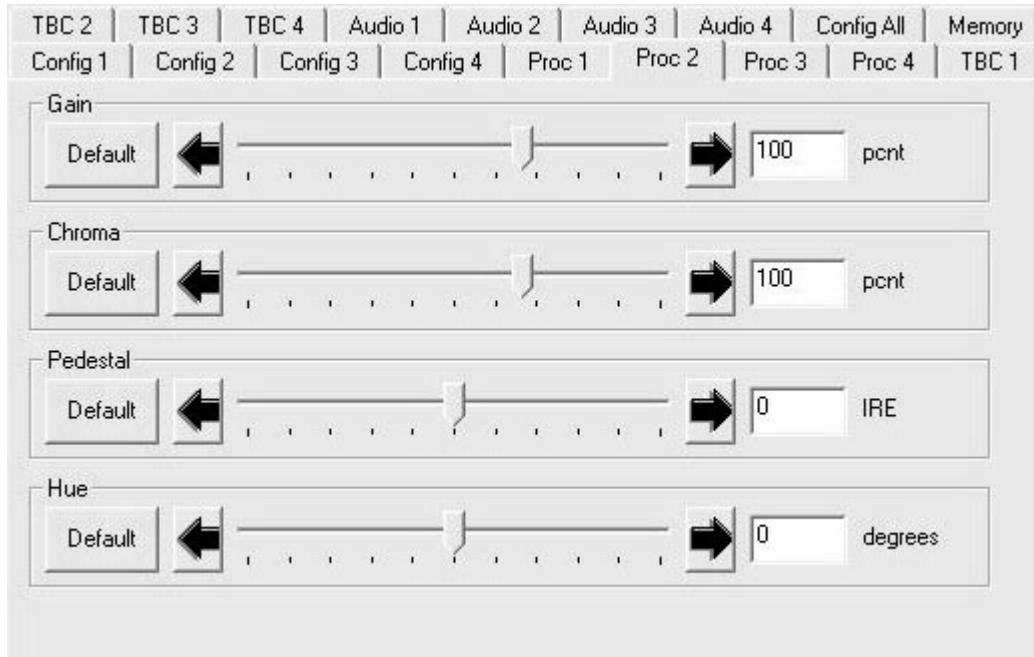

Use the **TBC 1 – 4** menus as shown in the example on the next page for Channel 1 to turn the time base corrector/frame sync function on and off, then adjust horizontal and vertical timing independently for each of the four channels with their respective TBC menus:

- **TBC/FrameSync** – turn TBC and Frame Sync functionality **On** or **Off**. The **TBC Status** window next to the control will indicate what the channel is locked to.
- **Hor Time** – adjust the horizontal timing of the channel in clocks. Available value range: **-1700 to 1700**.
- **Ver Time** – adjust the vertical timing of the channel in lines. Available value range: **-620 to 620**.

NOTE: The TBC menus are for model **5360** only. The **5365** does not have the TBC (time base corrector) functionality.

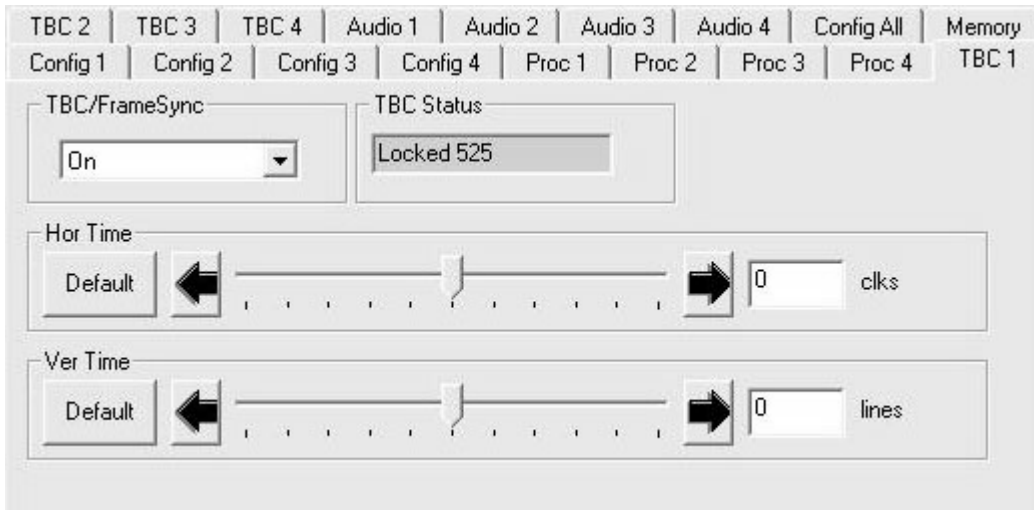

The **Audio 1** menu example shown below shows the configuration parameters available for each individual channel 1 – 4 in their respective Audio menus.

- **Audio Gain** – use this control to adjust the audio gain as desired, ranging from **-700 to 120 dB**.
- **Embedding** – use the drop-down menu to select the audio group to embed into the SDI output. Select from **Off**, **Group 1**, **Group 2**, **Group 3**, and **Group 4**.
- **Anlg Ref Level** – use the drop-down menu to select the analog reference level for embedding. Available values are: **-10 dB**, **-6 dB**, **-4 dB**, **0 dB**, **+4 dB**.

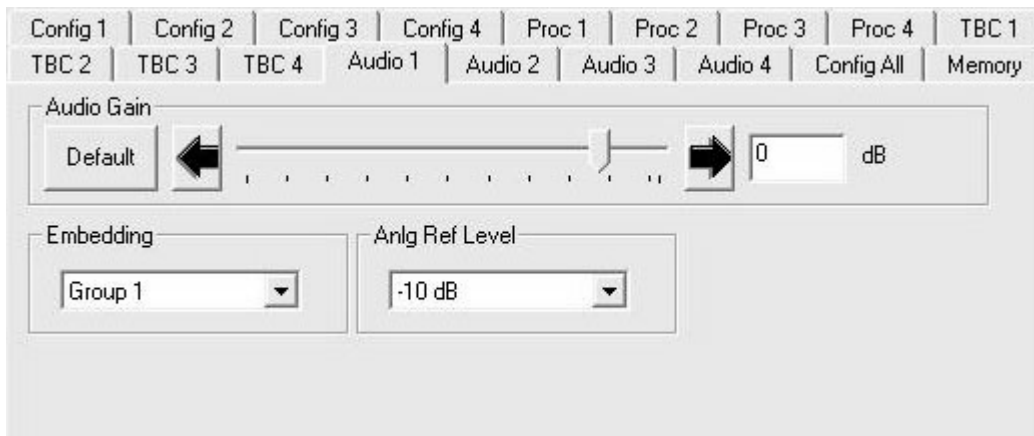

NOTE: The **Config All** menu as shown below is for model **5360**. For the **5365**, the Config All menu contains only the **Dig Ref Level** field.

The **Config All** menu shown below allows you to select and monitor the reference for all channels as follows:

- **Ref Source** – select the external input reference. Available values are: **Ext Ref**, **Master Ref**.
- The status of the reference input will be displayed in the **Reference** read-only window.
- **Dig Ref Level** – set the digital reference output level for the audio output. Select either **-20 dBFS** or **-18 dBFS**.

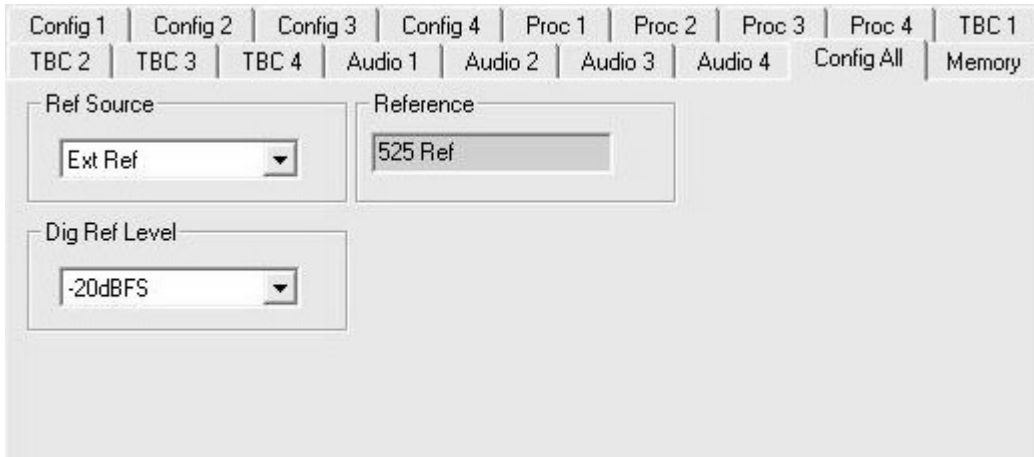

The **Memory** menu shown below allows you to save overall module setups to five memory registers as follows:

- Select **Save**, then one of the five memory registers **Reg 1 – 5**. The box will turn green. The entire module setup is now saved in the selected register.
- To recall a register, select the register box. If there is information saved, the box will turn green. The saved setup will now be loaded to the module. Up to five different module setups can be saved and recalled using the individual registers.

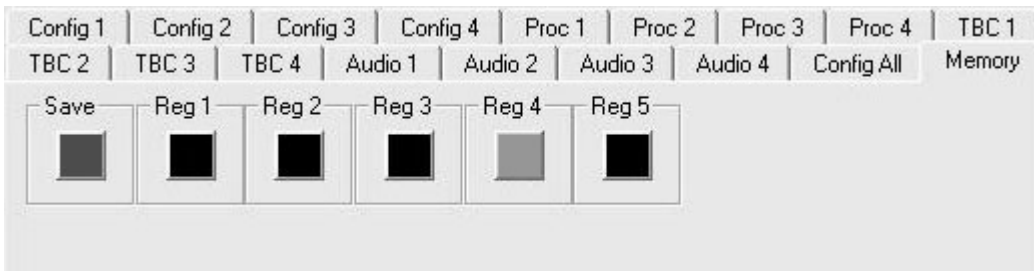

Avenue Touch Screen Remote Configuration

The Avenue Touch Screen remote control menus for this module are illustrated and explained below. Refer to the **5360 and 5365 Parameter Tables** for a summary of available parameters that can be set remotely through the menus illustrated.

Parameter fields that are grayed out can indicate one of the following conditions:

- An option is not installed.
- The function is not active.
- The module is locked.
- The User Level set with Avenue PC is not accessible from the current User Level.

5360 Touch Screen Menus

The **Config 1** menu example shown below shows the configuration parameters available for each individual channel 1 – 4 in their respective Config menus.

- **Blanking** – use this control to set the blanking for the channel as **Narrow** (lines 1-9 are blanked in NTSC, lines 1-6 in PAL) or **Wide** (lines 1-20 in NTSC, lines 1-22 in PAL).
- **Setup Removal** – use this control to turn setup removal **On** or **Off** depending on the requirement of the input signal.
- **Signal Mute** – set the action of the output when the input signal is lost. Available values are **No Muting**, **Mutes on Noise**, **Freeze on Noise**.
- **Test Pattern** – turn a Color Bars test pattern on or off. Available values are **Off**, **Bars**, **Black**.
- **Comb Mode** – set the comb mode for **3 Line** (best for video with motion) or **5 Line** decoding.

Status reporting is provided for the following conditions:

- **Input** – reports the input status as **No Input**, **525 Lock**, or **625 Lock**.

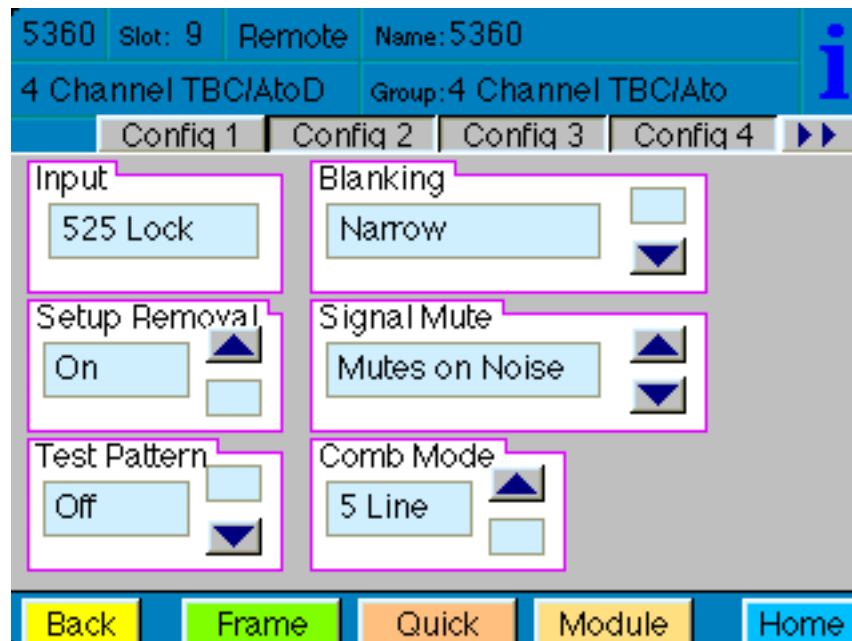

Repeat the configuration for each of the four input channels with their respective **Config** menus.

The **Proc 2** menu shown below gives an example of the adjustable video processing parameters for each channel in their respective Proc 1 – 4 menus:

- **Gain** – adjust the percentage of overall gain (luminance and chrominance). Available value range: **0 – 150%**.
- **Chroma** – adjust the percentage of chroma amplitude. Available value range: **0 – 150%**.
- **Pedestal** – adjust the pedestal (black) level of the signal in IRE. Available value range: **-30 – 30 IRE**.
- **Hue** – adjust the hue of the signal **± 180 degrees**.

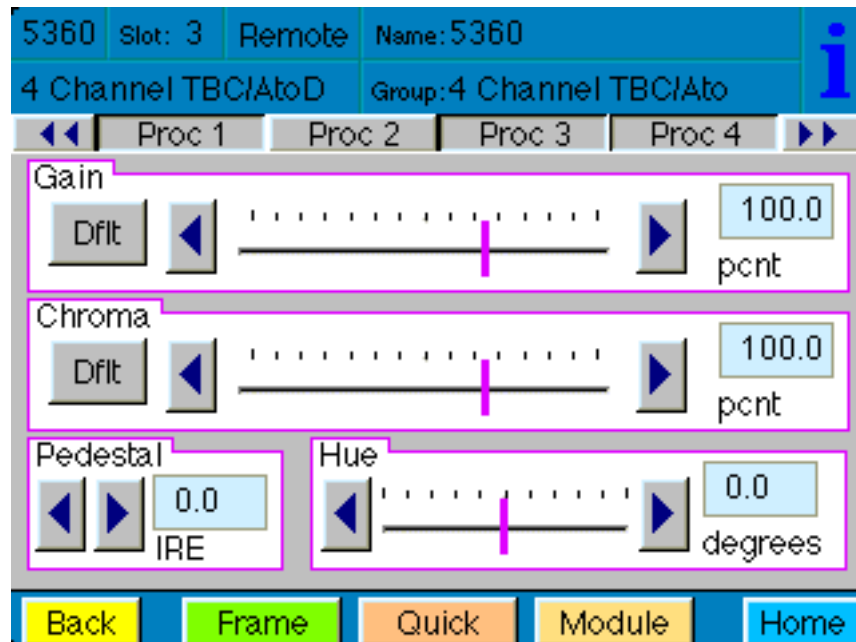

Use the **TBC 1 – 4** menus as shown in the example on the next page for Channel 1 to turn the time base corrector/frame sync function on and off, then adjust horizontal and vertical timing independently for each of the four channels with their respective TBC menus:

- **TBC/FrameSync** – turn TBC and Frame Sync functionality **On** or **Off**. The **TBC Status** window next to the control will indicate what the channel is locked to.
- **Hor Time** – adjust the horizontal timing of the channel in clocks.
- **Ver Time** – adjust the vertical timing of the channel in lines.

NOTE: The TBC menus are for model **5360** only. The **5365** does not have the TBC (time base corrector) functionality.

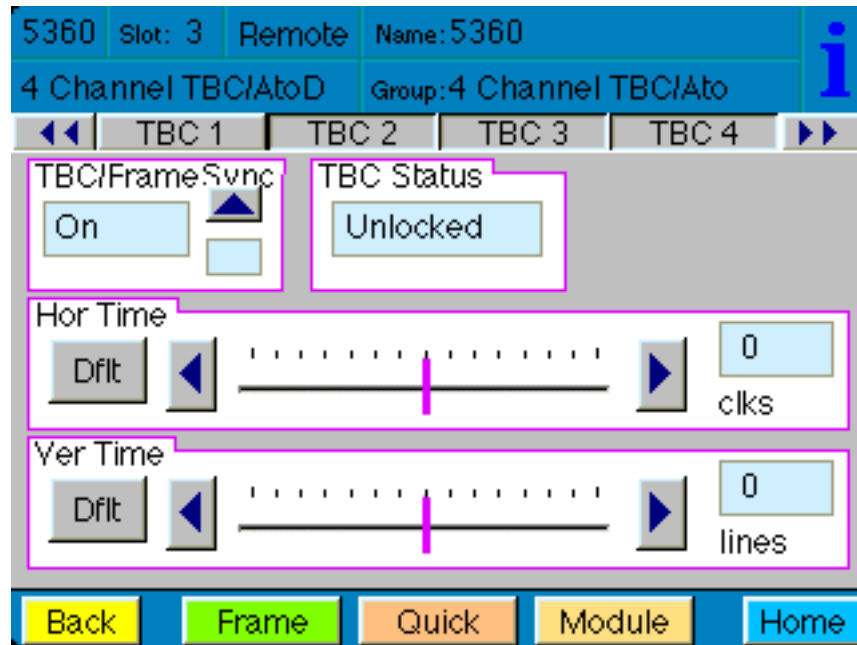

The **Audio 1** menu example shown below shows the configuration parameters available for each individual channel 1 – 4 in their respective Audio menus.

- **Audio Gain** – use this control to adjust the audio gain as desired, ranging from **-700 to 120 dB**.
- **Embedding** – use the drop-down menu to select the audio group to embed into the SDI output. Select from **Off**, **Group 1**, **Group 2**, **Group 3**, and **Group 4**.
- **Anlg Ref Level** – use the drop-down menu to select the analog reference level for embedding. Available values are: **-10 dB**, **-6 dB**, **-4 dB**, **0 dB**, **+4 dB**.

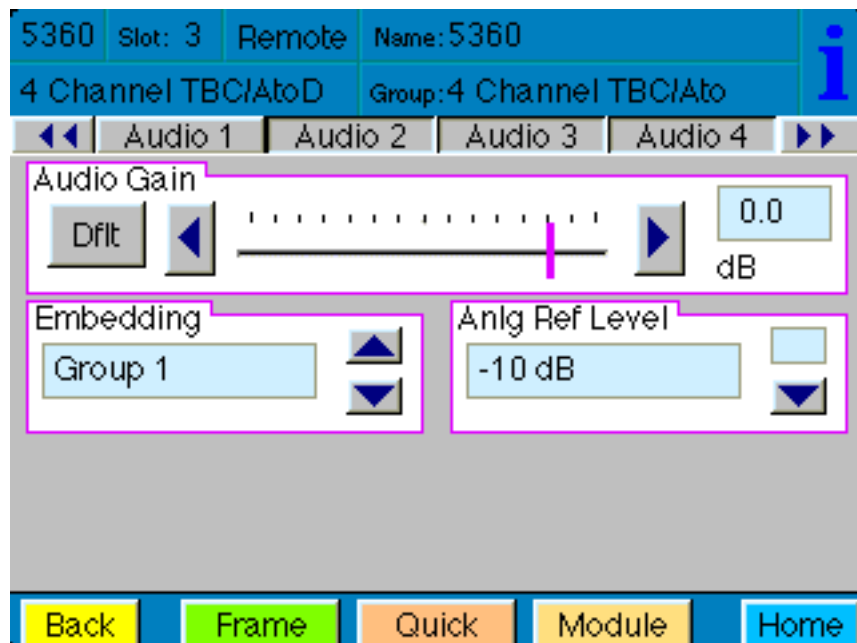

NOTE: The **Config All** menu as shown below is for model **5360**. For the **5365**, the Config All menu contains only the **Dig Ref Level** field.

The **Config All** menu shown below allows you to select and monitor the reference for all channels as follows:

- **Ref Source** – select the external input reference. Available values are: **Ext Ref**, **Master Ref**.
- The status of the reference input will be displayed in the **Reference** read-only window.
- **Dig Ref Level** – set the digital reference output level for the audio output. Select either **-20 dBFS** or **-18 dBFS**.

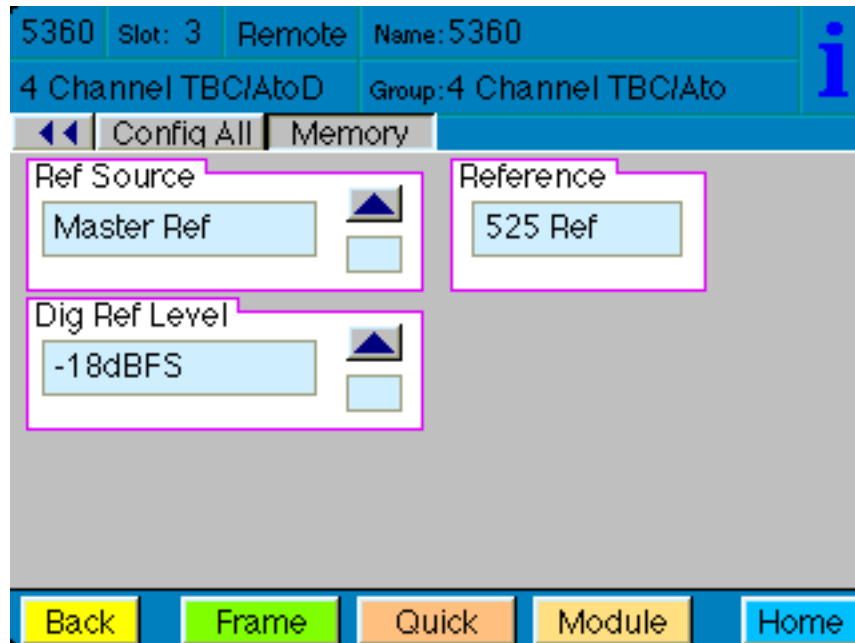

The **Memory** menu shown below allows you to save overall module setups to five memory registers as follows:

- Select **Save**, then one of the five memory registers **Reg 1 – 5**. The box will turn green. The entire module setup is now saved in the selected register.
- To recall a register, select the register box. If there is information saved, the box will turn green. The saved setup will now be loaded to the module. Up to five different module setups can be saved and recalled using the individual registers.

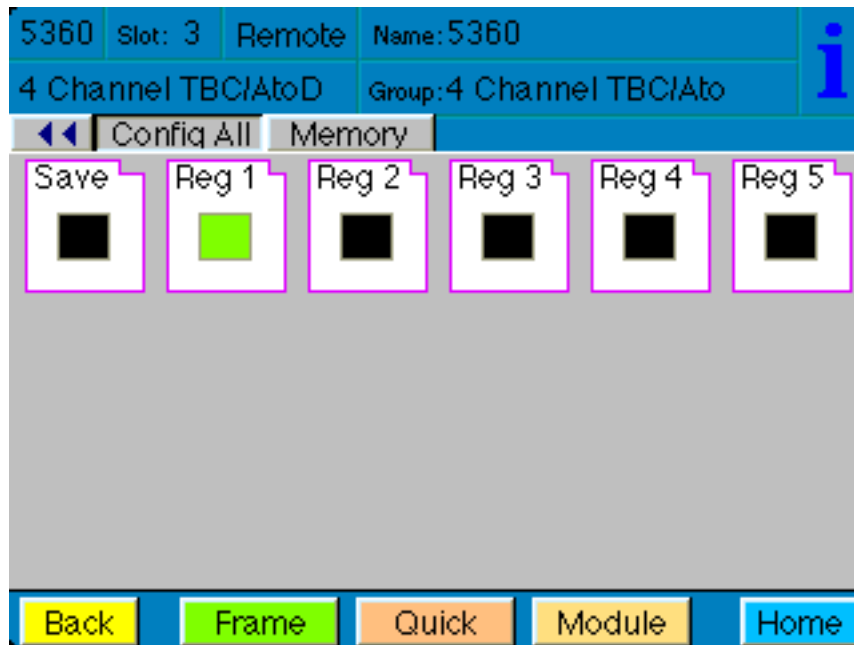

TROUBLESHOOTING

As a troubleshooting aid, the reference signal status and presence, power and CPU status can be easily monitored from the front panel of this module using the front panel indicators.

Refer to the overall troubleshooting tips given below for the module:

Can't control module:

- Check status of CPU **Run** green LED. Should be blinking slowly and in unison with other modules if System module is present. If not, try removing it and plugging it in again to be sure it is seated properly.
- System module may not be working properly if installed.

Module controls are grayed out:

- Module is locked or access to module controls is restricted by User Level.
- Local/Remote switch on module is in the **Local** position.

No signals out of module:

- Check status of **Ch1-4** LEDs. LEDs should be lit. If not, check all inputs for presence and quality.
- Check cabling to inputs of module.
- Check inputs to destinations are terminated properly.

You may also refer to the technical support section of the Ensemble Designs web site for the latest information on your equipment at the URL below:

<http://www.ensembledesigns.com/support>

SOFTWARE UPDATING

Software upgrades for each module can be downloaded remotely if the optional System Control module is installed. These can be downloaded onto your PC and then Avenue PC will distribute the update to the individual module. (Refer to the Avenue PC documentation for more information). Periodically updates will be posted on our web site. If you do not have the required System Control Module and Avenue PC, modules can be sent back to the factory for software upgrades.

WARRANTY AND FACTORY SERVICE

Warranty

This module is covered by a five year limited warranty, as stated in the main Preface of this manual. If you require service (under warranty or not), please contact Ensemble Designs and ask for customer service before you return the unit. This will allow the service technician to provide any other suggestions for identifying the problem and recommend possible solutions.

Factory Service

If you return equipment for repair, please get a Return Material Authorization Number (RMA) from the factory first.

Ship the product and a written description of the problem to:

Ensemble Designs, Inc.
Attention: Customer Service RMA #####
870 Gold Flat Rd.
Nevada City, CA. 95959 USA

(530) 478-1830

Fax: (530) 478-1832

service@ensembledesigns.com

<http://www.ensembledesigns.com>

Be sure to put your RMA number on the outside of the box.

SPECIFICATIONS

5360 4 Channel ADC/TBC

Analog Video Inputs (4 each)

Signal Type	NTSC, PAL Composite
Impedance	75 Ω
Return Loss	> 40 dB DC to 5.5 MHz
Input DC	± 1 volt DC
Input Hum	<100 mV

Reference Input (5360 only)

Signal Type	1 V P-P Composite Video, PAL or NTSC
Impedance	75 Ω
Return Loss	>40 dB

Serial Digital Outputs (4 each)

Signal Type	SMPTE 259M-C
Impedance	75 Ω
Return Loss	>15 dB
Output DC	None (AC coupled)

Analog Audio Input (2 per video input)

Analog Inputs	Eight, unbalanced pair
Processing	24 bits
Analog Input Z	>15 k Ω , unbalanced, transformerless

Analog Video to SDI Performance

Bit Resolution	12 bit input quantization, 4x oversampling
Decoding	Adaptive Comb Filter, 3 or 5 line selectable
Signal to Noise	>62 dB, weighted
Frequency Response	± 0.1 dB, 0 to 5.5 MHz

General Specifications

Power Consumption	10 watts
Temperature	0 to 40°C ambient (all specifications met)
Relative Humidity	0 to 95%, noncondensing
Altitude	0 to 10,000 ft

Due to ongoing product development, all specifications subject to change.