

CMN-41

Compact Video and Audio Monitor Installation and Operation Handbook

Printed September 2009

Item #061898 Rev. -

Copyright © 2009 by Harris Corporation. All rights reserved.

Contents of this publication may not be reproduced in any form without permission of Harris Corporation.

This instrument, in whole or in part, may be protected by one or more US (US Patent 6,069,607) or foreign patents or patent applications.

Specifications subject to change without notice.

IBM is a registered trademark of International Business Machines Corporation

PS2 is a registered trademark of International Business Machines Corporation

Dolby, AC-3, Dolby E, and the double D symbol are registered trademarks of Dolby Laboratories

Videotek and the Videotek logo are registered trademarks of Harris Corporation.

CineSound is a registered trademark of Harris Corporation.

IntelliMouse is a registered trademark of Microsoft Corporation

Operator's Safety Summary



WARNING: These instructions are for use by qualified personnel only. To reduce the risk of electric shock, do not perform this installation or any servicing unless you are qualified to do so. Refer all servicing to qualified service personnel.

Important Safety Instructions

- Read these instructions.
- Keep these instructions.
- Heed all warnings.
- Follow all instructions.
- Do not use this apparatus near water.
- Clean only with dry cloth.
- Do not block any ventilation openings. Install in accordance with the manufacturer's instructions.
- Do not install near any heat sources such as radiators, heat registers, stoves, or other apparatus (including amplifiers) that produce heat.
- Do not defeat the safety purpose of the polarized or grounding-type plug. A polarized plug has two blades with one wider than the other. A grounding type plug has two blades and a third grounding prong. The wide blade (or the third prong) is provided for your safety. If the provided plug does not fit into your outlet, consult an electrician for replacement of the obsolete outlet.
- Protect the power cord from being walked on or pinched particularly at plugs, convenience receptacles, and the point where they exit from the apparatus.
- Only use attachments/accessories specified by the manufacturer.
- Unplug this apparatus during lightning storms or when unused for long periods of time.
- Refer all servicing to qualified service personnel. Servicing is required when the apparatus has been damaged in any way, such as power-supply cord or plug is damaged, liquid has been spilled or objects have fallen into the apparatus, the apparatus has been exposed to rain or moisture, does not operate normally, or has been dropped.
- The device's IEC power connector shall remain readily accessible.

Ensuring Safety

- The unit should not be exposed to dripping or splashing, and no objects filled with liquids, such as vases, shall be placed on the unit.
- When the unit is to be permanently cabled, connect the protective ground conductor before making any other connections.
- Operate built-in units only when they are properly fitted into the system.
- For permanently cabled units without built-in fuses, automatic switches, or similar protective facilities, the AC supply line must be fitted with fuses rated to the units.
- Before switching on the unit, ensure that the operating voltage set at the unit matches the line voltage, if appropriate. If a different operating voltage is to be set, use a fuse with the appropriate rating. Refer to the Installation Instructions.
- Units of Protection Class I with an AC supply cable and plug that can be disconnected must be operated only from a power socket with protective ground contact:
 - Do not use an extension cable—it can render the protective ground connection ineffective.
 - Do not intentionally interrupt the protective ground conductor.
 - Do not break the protective ground conductor inside or outside the unit or loosen the protective ground connection; such actions can cause the unit to become electrically hazardous.
- Before opening the unit, isolate it from the AC supply. Then ensure that:
 - Adjustments, part replacements, maintenance, and repairs are carried out by qualified personnel only.
 - Safety regulations and rules are observed to prevent accidents.
 - Only original parts are used to replace parts relevant to safety (for example, the power on/off switches, power transformers, and fuses).
- Replaceable fuses can be hazardous when live. Before replacing a fuse, disconnect the AC power source.
- Use caution when cleaning the equipment; isopropyl alcohol or similar solvents can damage or remove the labels.
- Observe any additional safety instructions specified in this manual.

Explanation of Symbols

These symbols may appear on Harris equipment:



Read the *Operator's Handbook* or the *Service and Instruction Manual* and observe the safety symbols used.



Caution: shock hazard



Protective ground connection



Unit ground



Equipotentiality



Ground



Direct Current



Certification Labels and Symbol Locations

On Harris equipment, certification labels and symbols are located on the back panel, rear chassis sides, or bottom rear of the chassis. On smaller space-restricted units, most labels and symbols can be found on the bottom rear of the chassis.

This page is intentionally blank.

Directives and Compliances

This section provides information concerning Harris Corporation compliance with EU Directive 2002/95/EC and EU Directive 2002/96/EC.

Restriction on Hazardous Substances (RoHS) Directive 2002/95/EC

Directive 2002/95/EC—commonly known as the European Union (EU) Restriction on Hazardous Substances (RoHS)—sets limits on the use of certain substances found in electrical and electronic equipment. The intent of this legislation is to reduce the amount of hazardous chemicals that may leach out of landfill sites or otherwise contaminate the environment during end-of-life recycling. The Directive, which took effect on July 1, 2006, refers to the following hazardous substances:

- Lead (Pb)
- Mercury (Hg)
- Cadmium (Cd)
- Hexavalent Chromium (Cr-VI)
- Polybrominated Biphenyls (PBB)
- Polybrominated Diphenyl Ethers (PBDE)

In accordance with this EU Directive, all Harris products sold in the European Union will be fully RoHS-compliant and “lead-free.” Spare parts supplied for the repair and upgrade of equipment sold before July 1, 2006 are exempt from the legislation. Harris equipment that complies with the EU directive will be marked with a RoHS-compliant symbol, as shown in Figure 1.

Figure 1. RoHS Compliance Symbol



Waste from Electrical and Electronic Equipment (WEEE) Directive 2002/96/EC

The European Union (EU) Directive 2002/96/EC on Waste from Electrical and Electronic Equipment (WEEE) deals with the collection, treatment, recovery, and recycling of electrical and electronic waste products. The objective of the WEEE Directive is to assign the responsibility for the disposal of associated hazardous waste to either the producers or users of these products. As of August 13, 2005, producers or users are required to recycle electrical and electronic equipment at end of its useful life, and must not dispose of the equipment in landfills or by using other unapproved methods. (Some EU member states may have different deadlines.)

In accordance with this EU Directive, Harris Corporation and other companies selling electric or electronic devices in the EU will affix labels indicating that such products must be properly recycled.

Contact your local Harris sales representative for information on returning these products for recycling. Harris equipment that complies with the EU directive will be marked with a WEEE-compliant symbol, as shown in **Figure 2**.

Figure 2. WEEE Compliance Symbol



Contents

Operator's Safety Summary	iii
Important Safety Instructions.....	iii
Ensuring Safety.....	iv
Explanation of Symbols.....	v
Certification Labels and Symbol Locations	v
Directives and Compliances	vii
Restriction on Hazardous Substances (RoHS) Directive 2002/95/EC.....	vii
Waste from Electrical and Electronic Equipment (WEEE) Directive 2002/96/EC	vii
Section 1 ♦ Introduction	1
Product Description.....	1
Standard Features	1
Optional Features	2
Video Formats Supported	2
Front and Back Panels.....	5
Service and Support.....	6
Section 2 ♦ Installation	7
Inspecting the Shipment.....	7
Rack Mounting the CMN-41	8
DRT-4 Rack Mount Installation.....	9
Connecting the CMN-41.....	10
Ethernet Setup.....	11
Section 3 ♦ General Information	15
Terms	15
Overview.....	15
Types of Controls.....	15
Front Panel Controls	16
Sleep Mode.....	18
Selecting an Input	18
Display Selections.....	18
Full Screen Display	18
Overlay Display	20
Main Title Bar.....	21

Contents

Icons.....	21
Status Bar.....	21
Selecting an Internal or External Reference	21
Selecting a Function	21
Accessing and Navigating the Setup Menu	22
Capturing a Display	22
Storing a Captured Display	23
Recalling a Captured Display	23
Clearing a Captured Display.....	23
Capturing Display Data.....	23
Storing Captured Data	23
Recalling Captured Data	24
Clearing Captured Data	24
Section 4 ♦ Operating the CMN-41.....	25
Overview	25
Waveform Display.....	25
Waveform Front Panel Selections	28
Moving the Waveform	28
Selecting Horizontal or Vertical Sweep.....	28
Setting the Vertical and Horizontal Amplification Range	29
Selecting Components.....	30
Selecting Display Options	30
Placing the Waveform Display in Line Select Mode.....	30
Waveform Cursor Selections.....	31
Waveform Setup Menu	32
Vector Display	32
Vector Front Panel Selections	37
Setting the Vector Gain.....	37
Setting Display Options.....	38
Placing the Vector Display in Line Select Mode.....	38
Vector Cursor Selections	38
Vector Setup Menu	39
Gamut Display	39
Composite Gamut.....	41
RGB Gamut Display.....	42
Placing the Gamut Display in Line Select Mode.....	44
Setting Display Options.....	44
Gamut Setup Menu.....	44

Contents

Picture Display	44
Placing the Picture in Line Select Mode	46
Picture Setup Menu	46
PIP Display	46
Moving a PIP	47
Scaling a PIP	47
Removing a PIP	47
Audio Display	47
Audio Scales	48
Vertical Audio Displays	48
Expanding the Audio Display	54
Audio Mapping	54
Audio Setup	54
Alarm Display	54
Alarm Log Display	54
Alarm Status Display	56
Video Alarms	57
Audio Alarms	57
Time Code Alarms	57
GPI Alarms	57
Timing Display	57
SDI Input and External Reference Formats Supported	59
Things to Remember When Using the Timing Display	60
Timing Setup Menu	60
Option Display Selections	60
Moving the Waveform	60
Preset Display Selections	62
Selecting Presets	62
Storing Presets	62
Recalling Presets	62
Section 5 ♦ Global Setup Menu Functions.....	63
Navigating the Setup Menu	63
Setup Menus and Alarm Tables	64
Video Setup Menu Selection Options	73
Audio Mapping Setup Menu Selection Options	74
Time Code Source Setup Menu Selection Options	75
Waveform Setup Menu Selection Options	75
Vector Setup Menu Selection Options	77

Contents

Gamut Setup Menu Selection Options.....	78
Picture Setup Menu Selection Options	78
Audio Setup Menu Selection Options	80
Timing Setup Menu.....	81
OPT Setup Menu Selection Options.....	82
MLT Setup Menu Selection Options	82
Alarms Setup Menu	82
Import/Export Menu	82
Clear Setup Menu.....	83
Unit Configuration Display Setup Menu	83
About Display Screen	86
File Navigator.....	87
Section 6 ♦ Alarm Descriptions	89
Setting Alarms	89
Alarm Setup Menus	89
Video Alarms Setup Descriptions	94
Audio Alarms Setup Descriptions	96
Time Code Alarms Setup Descriptions.....	97
GPI Alarms	97
Alarm Log.....	97
Alarm Status.....	98
Section 7 ♦ External Control	99
Browser Interface.....	99
Section 8 ♦ Troubleshooting	101
Initial Checks	101
Restarting a Unit.....	101
Problems, Causes, and Solutions	101
Appendix A ♦ Specifications	103
3 Gb/s-SDI Input Specifications.....	103
HD-SDI Input Specifications.....	103
SD-SDI Input Specifications.....	103
External Reference Input Specifications	104
Digital Audio Input Specifications	104
3 Gb/s-SDI, HD-SDI, SD-SDI, Output Specifications	104
DVI Output Specifications	105
Analog Monitoring Output Specifications (Headphone).....	105

Contents

Control Specifications	105
Display Specifications	105
Waveform Display Characteristics – External Reference and LTC	106
Time Code Specifications.....	106
SDI Freeze	106
Gamut Display	106
Magnification.....	107
Communication Interfaces.....	107
Ethernet.....	107
Power Requirements.....	107
Mechanical	107
Environmental.....	108
Standard Accessories	108
Options	108
Appendix B ♦ Pinouts.....	109
Appendix C ♦ Open Source Software Copyright Information	113
FreeType License	113
LibJPEG License	113
CMU/UCD Copyright Notice	113
Networks Associates Technology, Inc. Copyright Notice (BSD)	114
Cambridge Broadband Ltd. Copyright Notice (BSD)	115
Sun Microsystems, Inc. Copyright Notice (BSD).....	116
Sparta, Inc. Copyright Notice (BSD).....	117
Cisco/BUPTNIC Copyright Notice (BSD).....	118
Fabasoft R&D Software GmbH & Co. KG Copyright Notice (BSD).....	119
The GNU v2 License.....	120
GNU General Public License.....	120
Version 2, June 1991	120
Preamble	120
GNU General Public License.....	121
Terms and Conditions for Copying, Distribution and Modification.....	121
No Warranty.....	124
GNU Lesser Public License.....	125
GNU Lesser General Public License	125
Version 2.1, February 1999	125
Preamble	125
GNU Lesser General Public License	127

Contents

Terms and Conditions for Copying, Distribution and Modification.....	127
No Warranty	132
Appendix D ♦ Glossary	133
Index	145
List of Figures	
Figure 1-1. CMN-41 Front and Back Panels.....	5
Figure 2-1. Mounting the CMN-41 in a Rack Using the DRT-4	8
Figure 2-2. CMN-41 Back Panel Connectors	10
Figure 2-3. CMN-41 Dedicated PC Connection.....	11
Figure 2-4. CMN-41 Network PC Connection.....	12
Figure 3-1. CMN-41 Front Panel Controls.....	16
Figure 3-2. Full Screen Display.....	19
Figure 3-3. Overlay Display	20
Figure 4-1. Waveform Display Diagram	26
Figure 4-2. RGB and YCbCr Graticule	27
Figure 4-3. RGB and YCbCr Zoom 0 mV Graticule	28
Figure 4-4. RGB and YCbCr Zoom 700 mV Graticule	28
Figure 4-5. Sample H/V Display.....	29
Figure 4-6. Establishing the Gain.....	30
Figure 4-7. Establishing Line Select.....	31
Figure 4-8. Establishing Cursor Select.....	31
Figure 4-9. Vector Display Diagram	32
Figure 4-10. Vector NTSC Graticule	33
Figure 4-11. Vector NTSC Zoom Upper Left	34
Figure 4-12. Vector NTSC Zoom Upper Right.....	34
Figure 4-13. Vector NTSC Zoom Lower Right.....	35
Figure 4-14. Vector NTSC Zoom Lower Left	35
Figure 4-15. Vector PAL Zoom Center.....	36
Figure 4-16. Vector SD with I/Q	36
Figure 4-17. Vector HD 75% + 100% Graticule	37
Figure 4-18. Establishing the Vector Gain.....	37
Figure 4-19. Establishing Line Select.....	38
Figure 4-20. Establishing Cursor Select.....	39
Figure 4-21. Gamut Display Diagram.....	40
Figure 4-22. Composite Gamut Vector Display Graticule Markings	42
Figure 4-23. Component (RGB) Gamut Vector Display Graticule Markings	43

Contents

Figure 4-24. Establishing Line Select	44
Figure 4-25. Picture Display Diagram.....	45
Figure 4-26. Aspect Ratio Source Diagram	46
Figure 4-27. Establishing Line Select.....	46
Figure 4-28. Sample PIP Display	47
Figure 4-29. Two Bar Graph Display with Lissajous Diagram	49
Figure 4-30. Four Bar Graph with Lissajous Display Diagram.....	50
Figure 4-31. Six Bar Graph Display Diagram.....	51
Figure 4-32. Eight Bar Graph Display Diagram.....	52
Figure 4-33. Sixteen Bar Graph Display Diagram.....	53
Figure 4-34. Alarm Log Display Diagram.....	55
Figure 4-35. Alarm Status Display Diagram.....	56
Figure 4-36. Timing Display Diagram	58
Figure 4-37. LTC Display Diagram.....	61
Figure 4-38. External Reference Display Diagram.....	61
Figure 5-1. Audio Mapping Matrix Display.....	75
Figure 5-2. About Display Screen	87
Figure 5-3. File Navigator Dialog Box.....	87
Figure 7-1. Sample Web Remote Display	99
Figure B-1. DVI-D Out Connector	109
Figure B-2. LTC/GPI 15-Pin, Female, D-Sub Connector.....	110
Figure B-3. Ethernet RJ-45 Connector	110
Figure B-4. USB Connector	110
Figure B-5. Power Connector.....	111

List of Tables

Table 1-1. CMN-41 Optional Features and Descriptions.....	2
Table 1-2. Options and Supported Video Formats.....	2
Table 1-3. 3 Gb/s Formats	3
Table 1-4. Dual Link Formats.....	4
Table 1-5. HD Formats	4
Table 1-6. SD Formats	4
Table 2-1. Parts Required to Rack Mount the CMN-41 Using the DRT-4.....	8
Table 2-2. Description of Back Panel Connectors	10
Table 3-1. CMN-41 Front Panel Controls	16
Table 3-2. Description of Full Screen Display.....	19
Table 3-3. Description of Overlay Display	20
Table 3-4. Description of Icons	21
Table 3-5. Setup Position Knobs and Navigation Button Functions.....	22

Contents

Table 4-1. Video Formats and Units of Measure	25
Table 4-2. Video Formats and Critical Amplitude Limits	25
Table 4-3. Description of Waveform Display Diagram	26
Table 4-4. Description of Vector Display Diagram	33
Table 4-5. Description of Gamut Display Diagram.....	40
Table 4-6. Description of Composite Gamut Indicators.....	42
Table 4-7. Description of RGB Gamut Indicators.....	43
Table 4-8. Description of Picture Display Diagram	45
Table 4-9. Description of Two Bar Graph Display with Lissajous Diagram	49
Table 4-10. Description of Four Bar Graph with Lissajous Display Diagram	50
Table 4-11. Description of Six Bar Graph Display Diagram	51
Table 4-12. Description of Eight Bar Graph Display Diagram	52
Table 4-13. Description of Sixteen Bar Graph Display Diagram.....	53
Table 4-14. Description of Alarm Log Display Diagram	55
Table 4-15. Description of Timing Display Diagram.....	58
Table 4-16. SDI Input and External Reference Formats Supported	59
Table 5-1. Setup Position Knobs and Navigation Buttons.....	63
Table 5-2. Setup Menu Tables.....	64
Table 5-3. Video Setup Menu	65
Table 5-4. Audio Mapping Menu	65
Table 5-5. Time Code Source Setup Menu	66
Table 5-6. Waveform Setup Menu	66
Table 5-7. Vector Setup Menu	67
Table 5-8. Gamut Setup Menu.....	67
Table 5-9. Picture Setup Menu	67
Table 5-10. Audio Setup Menu	68
Table 5-11. Timing Setup Menu.....	70
Table 5-12. OPT Setup Menu	70
Table 5-13. MLT Setup Menu	71
Table 5-14. Import/Export Setup Menu	71
Table 5-15. Clear Setup Menu.....	71
Table 5-16. Unit Configuration Setup Menu	71
Table 5-17. Input and Display Format Relationship.....	76
Table 6-1. Alarms Setup Menu	89
Table 6-2. Video Alarms Setup Menu	89
Table 6-3. Audio Alarms Setup Menu	92
Table 6-4. Time Code Alarms Setup Menu	93
Table 6-5. GPI Alarms Setup Menu	94

Contents

Table 8-1. CMN-41: Problems, Causes, and Solutions.....	101
Table B-1. Pinouts for DVI-D Out Connector	109
Table B-2. Pinouts for LTC/GPI Connector.....	110
Table B-3. Ethernet RJ-45 Connector Pinouts.....	110
Table B-4. USB Connector Pinouts.....	110
Table B-5. Power Connector Pinouts	111

This page is intentionally blank.

Section 1 ♦ Introduction

Product Description

The Harris CMN-41 compact video and audio monitoring unit is the most advanced, versatile, and intuitive monitoring instrument available today. The CMN-41 is available for HD-SDI/SD-SDI (which can be upgraded to 3 Gb/s capability in two SDI inputs). With 100% digital signal processing technology, the CMN-41 provides an accurate and stable user customizable display of waveform, vector, gamut, audio, picture, relative timing, and alarm status functions in full-screen views. In addition, the CMN-41 provides overlay display capabilities for vector, waveform, and picture-in-picture (PIP) functions. Quick setup and parameter changes are possible with direct access to display functions and screen location, 99 presets, context-sensitive shortcut menus, and an intuitive navigation system.

The CMN-41 features extensive audio and video alarm capabilities, including peak level reporting. All real-time signal alarms have user adjustable limits, time stamps from LTC or DVITC and an internal clock. Remote interfaces include 10/100Base-T Ethernet and plug-and-play USB port (supporting storage and recall of presets and frame-capture transfer). The CMN-41 instruments are digital instruments with all-digital architecture; therefore, no periodic calibration is required.

The CMN-41 seamlessly integrates into any broadcast, post-production, camera maintenance, satellite or cable facility, and is the ultimate choice for quality control, troubleshooting, or compliance checking applications.

Standard Features

- Two active loop-thru 3Gb/s-SDI/HD-SDI/SD-SDI video inputs with auto detection (version dependent)
- One AES input
- Passive looping external reference to support blackburst and tri-level sync
- 5x oversampling for enhanced audio True Peak detection
- All AES and embedded audio inputs are sample rate converted to 48 kHz
- Twelve-button numeric keypad
- Headphone jack
- Customizable function display screen location, multiple displays via overlay
- Alarms with Peak Level Report
- USB port for control and data transfer
- XGA, high resolution output for external display (DVI-D)
- Patented Video Relative Timing display
- Patented Gamut display
- 99 user presets

- Illuminated controls and indicators
- Ethernet
- Applicable standards: SMPTE 125M-1995, SMPTE 259M-1997, SMPTE 274M-2005, SMPTE 276M, SMPTE 292M-1998, SMPTE 296M-2001, SMPTE 352M-2002, SMPTE 372M-2002, SMPTE 424M-2006, SMPTE 425M-2006,, SMPTE RP 178-2004, SMPTE RP 198-1998, SMPTE RP 219-2002

Optional Features

The options available for the CMN-41 are shown in **Table 1-1**.

Table 1-1. CMN-41 Optional Features and Descriptions

Option	Description
TVM-WRTY2	Warranty option; adds three years to the standard two-year warranty
CMN-41	Supports SD-SDI and HD-SDI video
CMN-41-S	Supports SD-SDI video
CMN-41-3GB	Supports SD-SDI, HD-SDI, and 3Gb/s-SDI video
CMN-S2H-F	Field upgrade for CMN-41-S to support HD-SDI video
CMN-S23GB-F	Field upgrade for CMN-41-S to support HD-SDI and 3Gb/s-SDI video
CMN-H23G-F	Field upgrade for CMN-41 to support 3Gb/s-SDI
DRT-4	Double rack mount case
BLK-4	Blank panel for DRT-4

Video Formats Supported

NOTE: • = Supported Standards and formats

Table 1-2. Options and Supported Video Formats

Video Formats	CMN-41-S	CMN-41	CMN-41-3GB
DVB-ASI and SMPTE-310			
Analog Composite			
SD-SDI	•	•	•
HD-SDI		•	•
3 Gb/s-SDI			•
Dual Link - YCbCr 10 Bit 4:4:4			•
Dual Link –RGB and RGB+A, 10 Bit 4:4:4. and 4:4:4:4			•
Dual Link – YCbCr and RGB, 12 Bit 4:4:4			•

Table 1-3. 3 Gb/s Formats

Format	10 bit 4:2:2 YCBCR	10 bit 4:4:4 YCBCR	10 bit 4:4:4:4 YCBCR +A	10 bit 4:4:4 RGB	10 bit 4:4:4:4 RGB+A	12 bit 4:2:2 YCBCR	12 bit 4:4:4 YCBCR	12 bit 4:4:4 RGB
1080i								
1080i/60		•	•	•	•	•	•	•
1080i/59.94		•	•	•	•	•	•	•
1080i/50		•	•	•	•	•	•	•
1080p								
1080p/60	•							
1080p/59.94	•							
1080p/50	•							
1080p/30		•	•	•	•	•	•	•
1080p/29.97		•	•	•	•	•	•	•
1080p/25		•	•	•	•	•	•	•
1080p/24		•	•	•	•	•	•	•
1080p/23.98		•	•	•	•	•	•	•
1080psF/30		•	•	•	•	•	•	•
1080psF/29.97		•	•	•	•	•	•	•
1080psF/25		•	•	•	•	•	•	•
1080psF/24		•	•	•	•	•	•	•
1080psF/23.98		•	•	•	•	•	•	•
720p								
720p/60		•	•	•	•			
720p/59.94		•	•	•	•			
720p/50		•	•	•	•			
720p/30		•	•	•	•			
720p/29.97		•	•	•	•			
720p/24		•	•	•	•			
720p/23.98		•	•	•	•			

NOTE: Both Level A and Level B 3 Gb/s formats are supported. When a 3 Gb/s Level A signal is detected, the standard is shown with the letter "A" appended to the format (1080p/59.94 A). When a 3 Gb/s Level B signal is detected, the standard is shown with the letter "B" appended to the format (1080p/59.94 B).

Table 1-4. Dual Link Formats

Format	10 bit 4:2:2 YCbCr	10 bit 4:4:4 YCbCr	10 bit 4:4:4:4 YCbCr +A	10 bit 4:4:4 RGB	10 bit 4:4:4:4 RGB+A	12 bit 4:2:2 YCbCr	12 bit 4:4:4 YCbCr	12 bit 4:4:4 RGB
1080i								
1080i/60		•	•	•	•	•	•	•
1080i/59.94		•	•	•	•	•	•	•
1080i/50		•	•	•	•	•	•	•
1080p								
1080p/60	•							
1080p/59.94	•							
1080p/50	•							
1080p/30		•	•	•	•	•	•	•
1080p/29.97		•	•	•	•	•	•	•
1080p/25		•	•	•	•	•	•	•
1080p/24		•	•	•	•	•	•	•
1080p/23.98		•	•	•	•	•	•	•
1080psF/30		•	•	•	•	•	•	•
1080psF/29.97		•	•	•	•	•	•	•
1080psF/25		•	•	•	•	•	•	•
1080psF/24		•	•	•	•	•	•	•
1080psF/23.98		•	•	•	•	•	•	•

Table 1-5. HD Formats

	10 bit 4:2:2 YCbCr
1080i	
1080i/60	•
1080i/59.94	•
1080i/50	•
1080p	
1080P/30	•
1080P/29.97	•
1080P/25	•
1080P/24	•
1080P/23.98	•
720p	
720p/60	•
720p/59.94	•
720p/50	•
720p/30	•
720p/29.97	•
720p/24	•
720p/23.98	•
Segmented Frame	
1080P/30sF	•
1080P/29.97sF	•
1080P/25sF	•
1080P/24sF	•
1080P/23.98sF	•

Table 1-6. SD Formats

	10 bit 4:2:2 YCbCr
525/59.94	•
625/50	•

Front and Back Panels

The CMN-41 front and back panels are illustrated in **Figure 1-1**.

Figure 1-1. CMN-41 Front and Back Panels



Front Panel



Back Panel

Service and Support

For service and support, telephone the Harris Customer Service Department at **1-888-534-8246**. If the problem cannot be resolved over the telephone and the instrument must be shipped to Harris for service or repair:

- Obtain a Return Authorization (RA) number from the Harris Customer Service Department.
- Attach a tag to the unit with the following information:
 - Your company name, address, and telephone number
 - The name of the contact person at your company
 - The RA number
 - The unit serial number
 - An explanation of the problem
- To prevent shipping damage, pack the unit the same way Harris had packed it. If possible, use the original packing materials in the original shipping container.
- Ship the unit to the following location:

Harris Corporation
Videotek Test and Measurement
243 Shoemaker Road
Pottstown, PA 19464-6433
Attn: RA xxxx (where xxxx is the RA number)

Email: BCDService@harris.com

Section 2 ♦ Installation

This section provides information about inspecting, installing, and configuring the CMN-41.

Inspecting the Shipment

Before installing the CMN-41, inspect the box and the contents. Report any damage to the shipper, and then telephone the Harris Corporation Customer Service Department (see “Service and Support” on page 6).

NOTE: Refer to the enclosed packing sheet for the latest list of items that are supplied with the unit.

The box contains the following:

- One CMN-41 rasterizer
- One *CMN-41 Installation and Operation Handbook* on CD
- One 75Ω terminator
- One detachable power cord
- One power supply assembly
- One breakout connector (for LTC/GPI)

Save the box and packing material for any future shipping requirements.

Rack Mounting the CMN-41

When selecting the permanent mounting location for the CMN-41, make sure that the flow of air to the ventilation holes on the top and sides of the chassis is not obstructed.

Rack mounting the CMN-41 is illustrated in **Figure 2-1** for the DRT-4 rack mount case. **Table 2-1** lists the parts required to rack mount the CMN-41 into the DRT-4 rack mount case.

Figure 2-1. Mounting the CMN-41 in a Rack Using the DRT-4

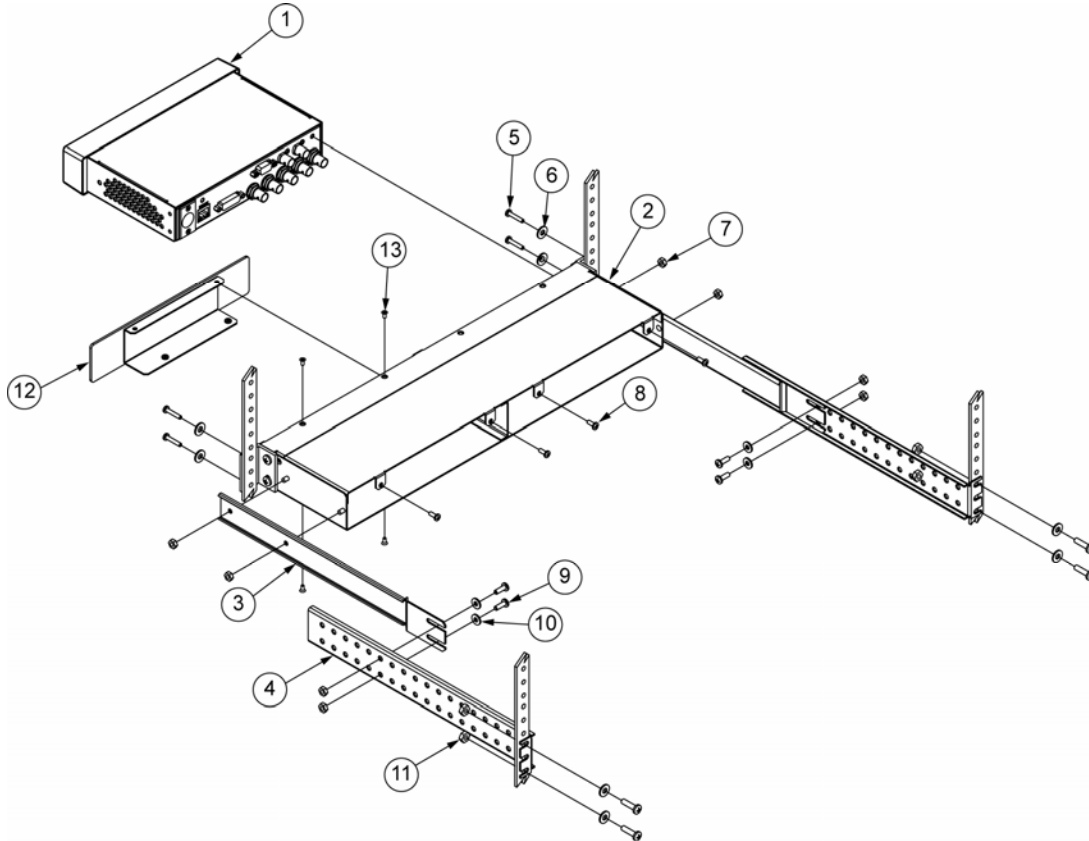

NOTE: Although only one CMN-41 unit is shown in Table 2-1, two CMN-41 units may be mounted into a DRT-4 rack case.

Table 2-1. Parts Required to Rack Mount the CMN-41 Using the DRT-4

Key	Item Number	Qty	Description
1	—	A/R	CMN-41 unit
2	866080	1	DRT-4 rack tray
3	832072	2	Metal extension mount
4	832070	2	Metal extension bracket
5	831030	8	#10-32× ³ / ₄ -in. Phillips head screws
6	831019	4	Nylon washer, rack mount
7	831119	8	#8-32 keps nuts
8	831131	4	#8-32× ³ / ₈ -in. Phillips head screws (CMN mtg)
9	831064	4	#8-32× ¹ / ₂ -in. Phillips head screws

Table 2-1. Parts Required to Rack Mount the CMN-41 Using the DRT-4

Key	Item Number	Qty	Description
10	831118	8	#10 flat washers
11	831030	4	#10-32×¾-in. Phillips head screws
	866073		FP BLK-4 (optional cover plate)
12	832131	1	DRT-4 metal blank panel
13	831136	4	#4-40×¼ self-tapping Phillips head screws

DRT-4 Rack Mount Installation

1. Install the extension bracket mounts (ITEM 3) to both sides of the chassis (ITEM 2) using four #8-32 kee nuts (ITEM 7)
2. Install the assembled unit in a rack using #10-32×¾-in Phillips head screws (ITEM 5) and washers (ITEM 6) through the chassis front mounting ears, as shown.
3. Hold the extension bracket (ITEM 4) in place on each side of the chassis, and loosely install #8-32×½-in. Phillips head screws (ITEM 9), #10 flat washers (ITEM 10), and #8-32 kee nuts (ITEM 7) into the holes that align with the slots in the metal extension mount (ITEM 3).
4. Install the #10-32×¾-in. Phillips head screws (ITEM 5), #10 flat washers (ITEM 10), and #10-32×¾-in. Phillips head screws (ITEM 11) through the rack rails and the appropriate slots in the back of the metal extension bracket (ITEM 4), and then tighten them.
5. Tighten the remaining hardware that joins the bracket pairs (ITEM 3 and ITEM 4).
6. Using ⅜-in. Phillips head screws (ITEM 8), secure the CMN-41 unit to the back of the DRT-4 rack case.
7. If desired, install the optional BLK-4 cover plate:
 - Slide the metal cover plate (ITEM 12) into the desired side of the DRT-4 rack.
 - Using 4 self tapping screws (ITEM 13), secure the cover plate into the DRC-3 rack.
8. The installation is complete.

Connecting the CMN-41

The back panel connectors are illustrated in **Figure 2-2**, and the function of each connector is described in **Table 2-2**.

Figure 2-2. CMN-41 Back Panel Connectors

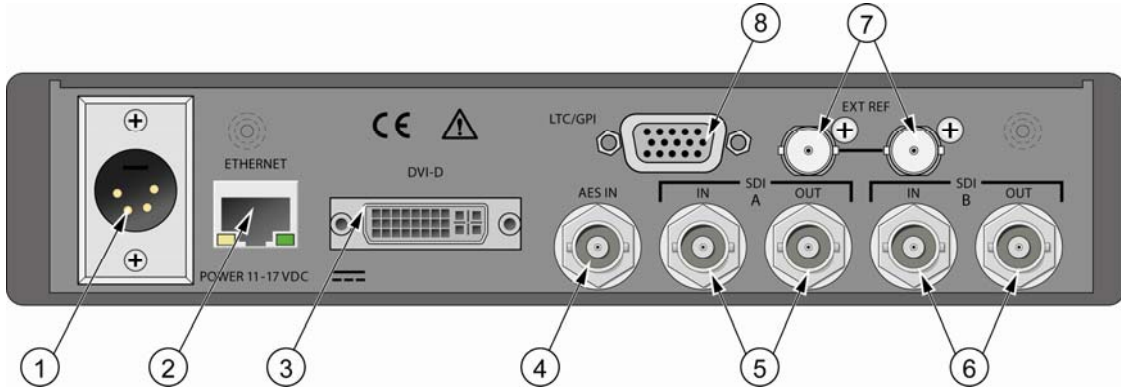

Table 2-2. Description of Back Panel Connectors

Key	Label	Description
1	PWR 11-17VDC	Power connector
2	ETHERNET	RJ45, female, 10/100Base-T Ethernet connector*
3	DVI-D	DVI connector for external monitor
4	AES IN	AES input BNC connector
5	SDI A	Input and output BNC connectors for SDI A
6	SDI B	Input and output BNC connectors for SDI B
7	EXT REF	External reference input and loop through
8	LTC/GPI	15-pin, high-density, female, D-sub connector for LTC/GPI/TALLY input*

*See "Pinouts" starting on page 109 for the connections.

Ethernet Setup

NOTE: The Ethernet default settings for the CMN-41 are as follows:

IP: 192.0.0.100

Subnet Mask: 255.255.255.192

Gateway: 255.255.255.255

1. Prior to performing the CMN-41 network configuration, obtain TCP/IP addresses from the system administrator or the Internet service provider (ISP). These addresses are a static IP address (unless using Dynamic Host Configuration Protocol [DHCP]), a subnet mask, and an optional gateway IP.

Be sure to record all addresses in the spaces provided below. The gateway address is not needed unless the CMN-41 is routed to an outside network.

Record the addresses:

CMN-41 Interface Static IP Address	
CMN-41 Interface Subnet Mask	
Gateway IP Address	

2. Identify a host PC to configure and test the CMN-41.
3. Choose a dedicated PC connection or network connection method:
 - For a dedicated PC connection, connect the host PC with a network card to the “ENET” connector on the back panel of the CMN-41, using a CAT5 crossover cable (not included). See **Figure 2-3**.

Figure 2-3. CMN-41 Dedicated PC Connection

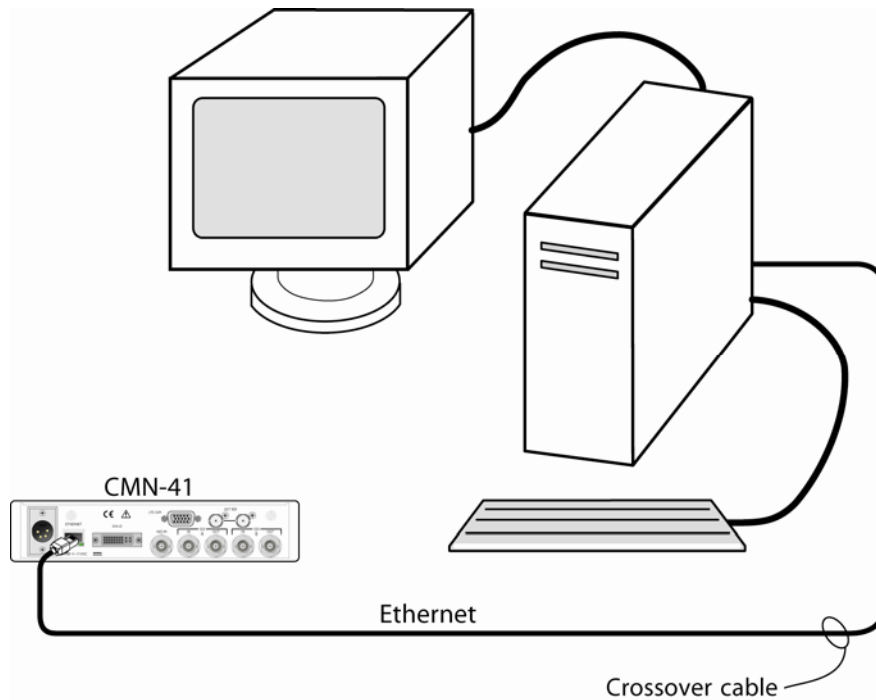

- For a network connection, connect the network hub to the back panel of the CMN-41 using a CAT5 network cable (not included). See **Figure 2-4**.

Figure 2-4. CMN-41 Network PC Connection

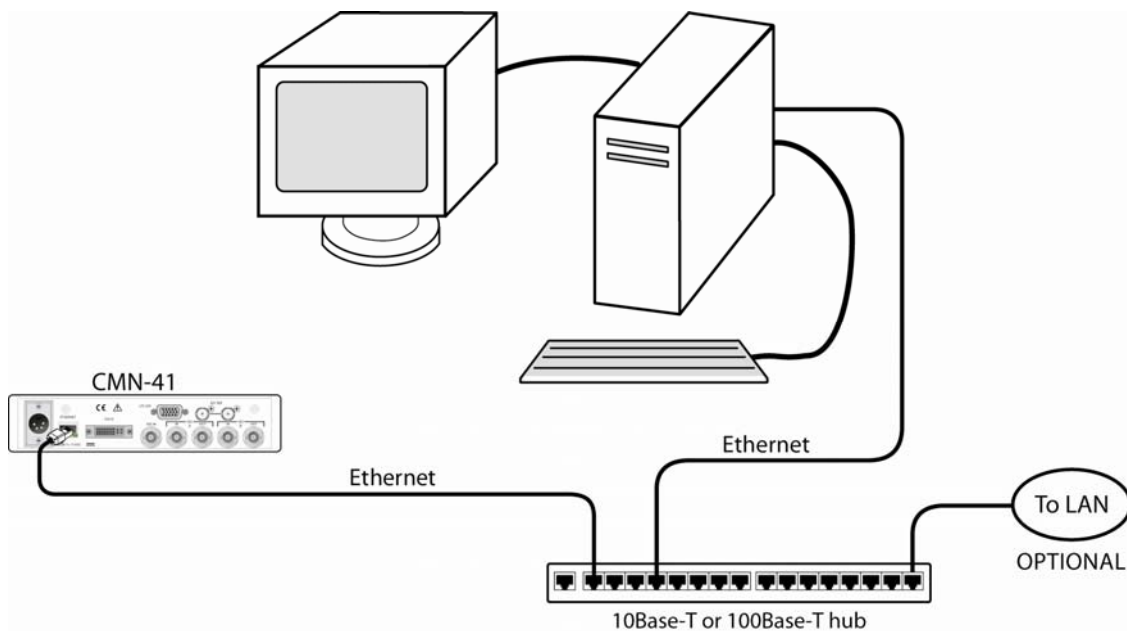

4. Set up an Ethernet configuration as follows:

- Press the SETUP button on the CMN-41 front panel.
- Press the Up/Down arrow button to highlight the Unit Configuration Setup menu, and then press the ENTER button to enter the submenu.
- Press the Up/Down arrow button until the IP CONFIGURATION selection option is highlighted.
- Press the ENTER button or Left/Right arrow button to enter the Ethernet Config selection option.
- If using DHCP:
 - Press the Left/Right arrow button to highlight DHCP.
 - Press the Up/Down arrow button to toggle the state to ON.
 - Press the Left/Right arrow button to highlight ACCEPT, and then press the ENTER button.

The IP Address is retrieved from the DHCP server and placed under the appropriate submenu.

- If not using DHCP:
 - Press the Left/Right arrow button to select IP ADDRESS.
 - Press the Up/Down arrow button to change the value selected, and then press the Left/Right arrow button to highlight the next value.

- Repeat for the remainder of the IP Address, Subnet Mask, and Gateway. To avoid conflicts, the static IP Address, Subnet Mask, and Gateway should be obtained from the System Administrator.
- g) Press the Left/Right arrow button to highlight ACCEPT, and then press ENTER to accept the entered values.
- h) Press the EXIT button to exit the submenu.

This page is intentionally blank.

Section 3 ♦ General Information

Terms

The following terms are used in this section:

- **Display:** The output at the DVI connector
- **Full:** Full-screen display of the selected input
- **MLT:** Overlay multi-mode operational state

Overview

The CMN-41, shown in **Figure 3-1** and described in **Table 3-1**, can display one input at a time, in full-screen mode. Each screen provides a user-selectable customized display of waveform, vector, gamut, audio, picture, relative timing, or alarm functions.

NOTE: Pressing and holding certain buttons will activate menus for additional functionality. See **Table 3-1** for more information.

Types of Controls

The CMN-41 is controlled in three ways:

- **Quick Controls:** Controls on the front panel that adjust parameters that are frequently used.
- **Menu Settings:** Shortcut menus within a function that are used to control the parameters for the individual function.
- **Global Setup Menu Settings:** Setup menu parameters that affect the entire unit (not function-specific). The Setup menu is accessed by pressing the SETUP button.

Front Panel Controls

The front panel controls are illustrated in **Figure 3-1**.

Figure 3-1. CMN-41 Front Panel Controls

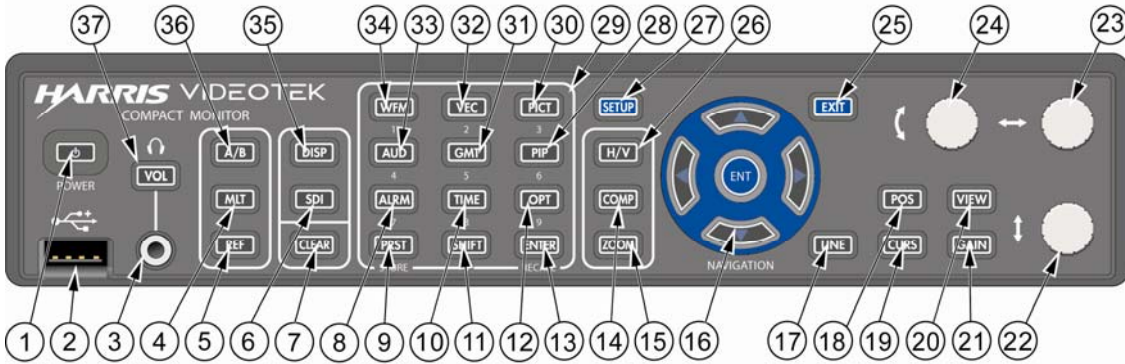

Most buttons and text are in a low-tally (low illumination) state; under certain conditions, however, some buttons and text reach a high-tally (high illumination) state, as described in **Table 3-1**. If a function is not operational, the associated button illumination is OFF. The high and low tally illumination levels can be set in the High Tally and Low Tally selection options of the Unit Configuration → Front Panel setup menu selection option.

NOTE: Multiple buttons may be high tally at the same time. The last control selected is the active control.

Table 3-1. CMN-41 Front Panel Controls



Key	Label	Description
1	POWER	<ul style="list-style-type: none"> Power switch button; press and release to turn unit power on Press and hold to turn unit power off
2		USB port
3		Headphone jack
4	MLT	<ul style="list-style-type: none"> Multi-display or Overlay button; press and release to toggle between a full-display and a multi-display screen Press and hold to access the MLT Setup menu
5	REF	External Reference selection button; press and release to toggle between internal and external reference
6	SDI	<ul style="list-style-type: none"> Data button; press and release to freeze data Once data is frozen, press and release to toggle between live and frozen mode
7	CLEAR	<ul style="list-style-type: none"> Clear Display selection button; press and release to clear a display Press and hold to access the Clear Setup menu
8	ALRM	<ul style="list-style-type: none"> Alarm selection button; press and release to switch to Alarm mode Press and hold to access the Alarm Setup menus
9	PRST	Preset selection button; press and release to enable Preset selection
10	TIME	<ul style="list-style-type: none"> Timing selection button; press and release to switch to Timing mode Press and hold to access the Timing Setup menu
11	SHIFT	Shift selection entry button; press and release to use numeric keypad for direct parameter entry

Table 3-1. CMN-41 Front Panel Controls

Key	Label	Description
12	OPT	<ul style="list-style-type: none"> Option selection button; press and release for the LTC or REF waveform displays Press and hold to access the OPT menu
13	ENTER	Press and release to accept the contents of displayed dialog boxes
14	COMP	Component selection button; press and release to cycle through individual waveform components
15	ZOOM	Zoom selection button; press and release for zoom selections
16	Navigation	Use to navigate menus and select selection options (see page 17 for an explanation of how to operate the navigation items)
17	LINE	Line selection button; press and release to activate Line Selection mode
18	POS	Position selection button; press and release to enable controls to horizontally or vertically adjust the contents of a WFM, LTC, or REF waveform display
19	CURS	Cursor selection button; press and release to select cursor functionality for a waveform or vector display
20	VIEW	View Adjust selection button; press and release to enable controls to scale or adjust the position of an active display
21	GAIN	Gain Control selection button; press and release to activate Gain controls
22	Up/Down Arrow Knob	Use to move the waveform display
23	Left/Right Arrow Knob	Use to move the waveform display
24	Curved Arrow Knob	Use for vector, cursor, and output audio level
25	EXIT	Exit selection button; press and release to leave menu function selections
26	H/V	Horizontal/vertical sweep selection button; press and release to toggle between waveform horizontal and vertical sweep
27	SETUP	<ul style="list-style-type: none"> Setup button; press and release to access Setup mode Press and release to exit the displayed Setup menu
28	PIP	<ul style="list-style-type: none"> Picture-in-picture selection button; press and release for a thumbnail display of the current picture available with the selected input
29		<ul style="list-style-type: none"> Press to select, store, or delete a selection in the Preset memory bank Press to enter numeric values for certain parameters (the Shift button will be high tally to indicate that the numeric keypad is available for direct parameter entry)
30	PICT	<ul style="list-style-type: none"> Picture selection button; press and release for a picture display Press and hold to access the Picture Setup menu
31	GMT	<ul style="list-style-type: none"> Gamut selection button; press and release for a gamut display Press and hold to access the Gamut Setup menu
32	VEC	<ul style="list-style-type: none"> Vector selection button; press and release for a vector display Press and hold to access the Vector Setup menu
33	AUD	<ul style="list-style-type: none"> Audio selection button; press and release for an audio display Press and hold to access the Audio Setup menu
34	WFM	<ul style="list-style-type: none"> Waveform selection button; press and release for a waveform display Press and hold to access the Waveform Setup menu
35	DISP	<ul style="list-style-type: none"> Display button; press and release to freeze a display Once a display is frozen, press and release to toggle between live and frozen mode
36	A/B	SDI input button, press to toggle between SDI input A and B

Table 3-1. CMN-41 Front Panel Controls

Key	Label	Description
37	VOL	<ul style="list-style-type: none"> • Volume selection button; press and release to activate the curved knob to adjust headphone audio volume • Press and hold to access the audio channel selection matrix

Sleep Mode

To setup up Sleep mode, choose the UNIT CONFIGURATION → DISPLAY SETUP → SLEEP MODE selection option. This menu allows the selection of how much time has to pass without any button presses in order for the unit to enter Sleep mode.

When entering Sleep mode, the instrument will turn off all LEDs and the display. The instrument is still active (that is, alarms still triggered, and so forth). When exiting Sleep mode, the instrument returns to an illuminated state.

Selecting an Input

Press the A/B Input button to select input A or B. (Input A is the default selection.) When an input is selected, pressing the input button again will change to the new input from the previous input. High tally indicates input A is selected.

Display Selections

The CMN-41 unit screen display shows data in either a full-screen or an overlay display. The screen display also contains the Main Title Bar, the display, and the status bar.



Press the MLT button to toggle between full screen or overlay display. MLT is high tally when selected.

Full Screen Display

The Full Screen display mode shows a full-screen representation of a waveform, picture, alarm, vector, gamut, audio, or timing display for a single input at a time.

A sample Full Screen display is shown in **Figure 3-2** and described in **Table 3-2**.

Figure 3-2. Full Screen Display

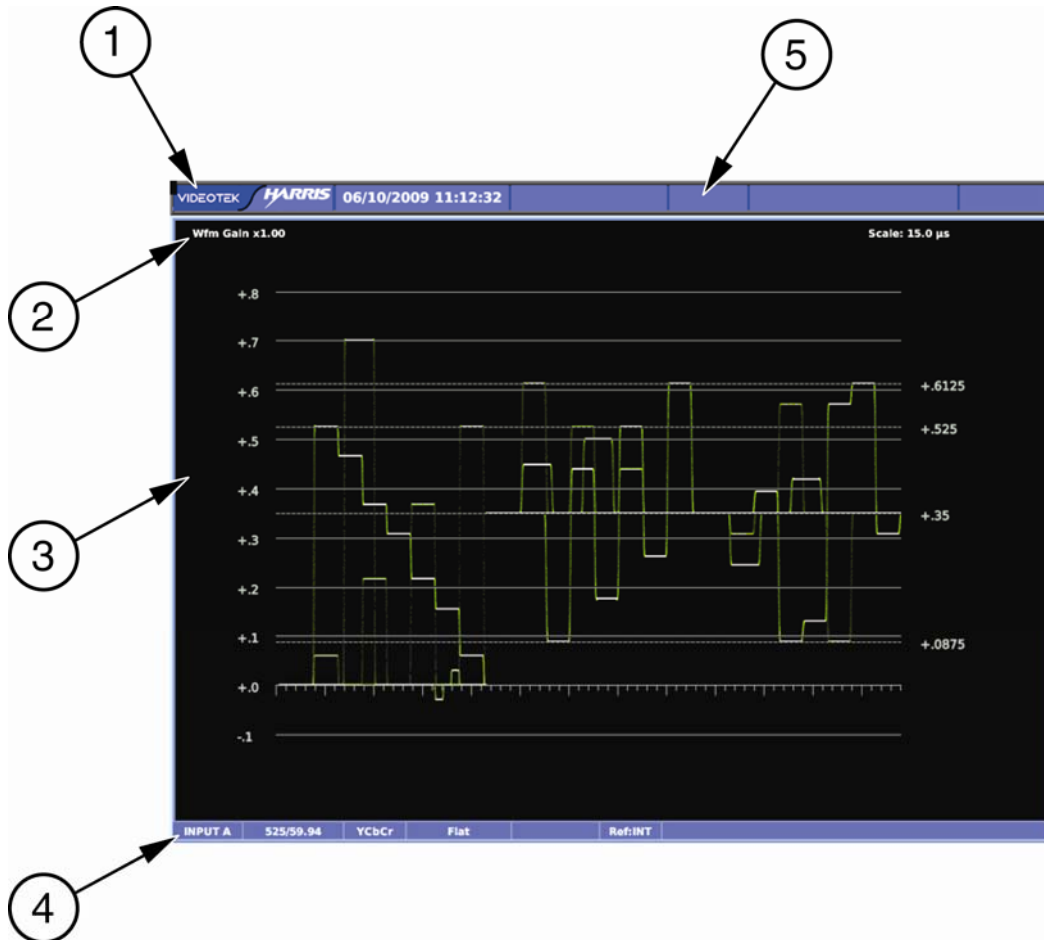

Table 3-2. Description of Full Screen Display

Key	Description
1	Main title bar
2	Specific elements of function display (waveform, vector, etc.)
3	Full screen display
4	Full screen status bar
5	Display icon area

Overlay Display

Overlay mode is a combination of the waveform, vector, and (if desired) picture-in-picture (PIP) displays. Descriptions of these display types start on page 25.

A sample Overlay display is shown in **Figure 3-3** and described in **Table 3-3**.

Figure 3-3. Overlay Display

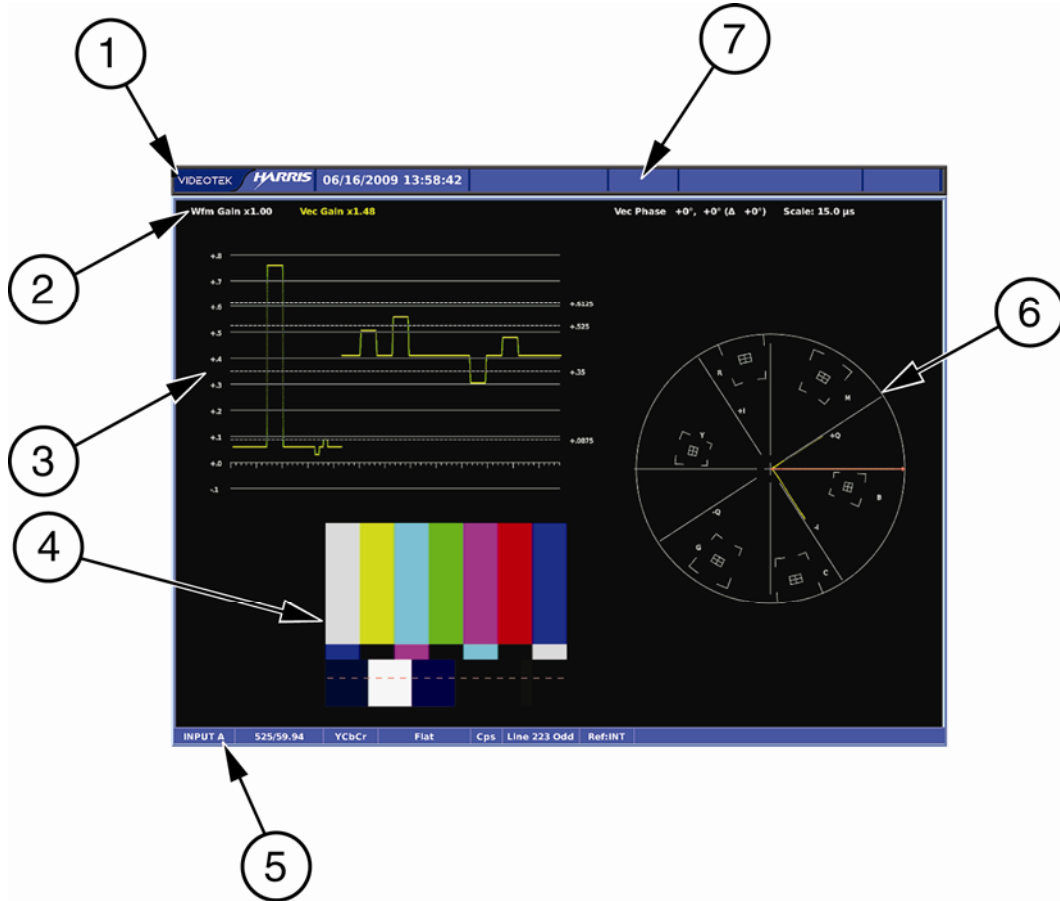

Table 3-3. Description of Overlay Display

Key	Description
1	Main title bar
2	Specific elements of function display
3	Waveform display
4	PIP display
5	Overlay status bar
6	Vector display
7	Display icon area

Each component in the Overlay display can be adjusted individually. Use the appropriate function button (that is, WFM, VEC, or PIP) to select the display to be adjusted. Refer to the appropriate function description sections for more information.

To move a selected display component, make sure the VIEW button is in high tally. Use the Up/Down and Left/Right arrow knobs to move the selected display to the desired location on the screen. Use the curved arrow knob to scale the size of the selected display.

Main Title Bar



The main title bar is displayed at the top of the screen, and contains the Company name, date and time, icon indicators, most current alarm (alarm background color is yellow when active), and the model name.

Icons

Icons appear in the main title bar and are shown in a specified order (left to right).

Table 3-4 shows the icons and the condition for the appearance:

Table 3-4. Description of Icons

Icon	Condition
	External USB device connected
	Alarm condition active
	DISP or SDI data is frozen in memory. If a display is captured and in memory, DISP overlays the icon. If SDI is captured and in memory, SDI overlays the icon. If both DISP and SDI are captured and in memory, DISP and SDI overlay the icon.

Status Bar

A status bar is located at the bottom of each display. The status bar displays information based on the function selected and configuration applied. See the specific function section (Waveform, Vector, Gamut, Picture, PIP, Audio, Alarm, Timing, and Option) for more detailed information on the status bar that is displayed.

Selecting an Internal or External Reference

Press and release the REF button to toggle between internal and external reference.

Selecting a Function

Press the appropriate function button to select Waveform, Vector, Gamut, Picture, Picture-in-Picture, Audio, Alarm, Timing, or Option for the display. Press and hold the function button to display the pertinent Setup menu.

NOTE: The different function operations are described in detail in Section 4.

When a button is pressed that cannot be used with a selected function (Waveform, Vector, and so forth), the message FUNCTION NOT ALLOWED briefly appears over the center of the screen.

Accessing and Navigating the Setup Menu



Press the SETUP button to access the global Setup menu. Specific function setup menus can be accessed directly by pressing and holding the corresponding function button.

For more information on the global Setup menu, see page 64.

Use the navigation buttons or the setup position knobs to navigate the Setup menu. The setup position knobs and navigation buttons are described in **Table 3-5**.

Table 3-5. Setup Position Knobs and Navigation Button Functions

Button/Knob	Function
	Press to exit the Setup menu.
	Press to enter or exit the Setup menu.
	Press to select a menu item, or open a menu or submenu.
	Press to move up in a menu or submenu tree.
	Press to move right to the next submenu.
	Press to move out of a submenu.
	Press to move down in a menu or submenu.
	Rotate to set numeric values for certain parameters. Press to set parameter to default value.
	Press to use the numeric keypad for direct parameter entry. The Shift button will be high tally to indicate that the numeric keypad is available for direct parameter entry.

Capturing a Display



The CMN-41 is capable of holding frame-captured displays in internal memory. The DISP button is high tally when a capture is performed or recalled. If no frame had been captured, press the DISP button to capture the screen.

Only one captured frame can be cached in the unit at a time. The frame will remain cached until the frame is cleared. Once the frame is frozen and the DISP button is high tally, press the DISP button to toggle between the captured frame and the live frame.

Storing a Captured Display

While a captured frame is shown, press the STORE button to save the captured frame to internal memory. The captured frame can be recalled at a later time by using the RECALL button. In addition, the EXPORT selection option can be used to transfer the display capture to a USB device via the File Navigator dialog box, or the web browser interface can be used to access the display capture. For more information on the File Navigator dialog box, see page 87. For more information on the web browser interface, see page 99.

Recalling a Captured Display

While a captured frame is shown, press the RECALL button to recall a captured frame from internal memory via the File Navigator dialog box. For more information on the File Navigator dialog box, see page 87.

Clearing a Captured Display

While a captured frame is shown, press the CLEAR button to clear the frozen frame. Once the frozen frame is cleared, a new frame capture can be performed.

Capturing Display Data



The CMN-41 can hold frame-captured information in internal memory. The SDI button is high tally when a capture is performed or recalled.

If no data had been captured, press the SDI button to capture the data. The SDI button is high tally when information is captured. Only one captured data can be cached in the unit at a time. The data will remain cached until the data is cleared. Once the data is frozen and the SDI button is high tally, press the SDI button to toggle between displaying the captured data and the live data.

When selecting a different function, the SDI button will change according to the current configuration of that frame (that is, if the captured data in the cache is displayed or not displayed). When returning to a function that already contains and displays the cached captured data, the SDI button reaches a high-tally state.

SDI is deselected if the SDI or the CLEAR button is pressed.

Storing Captured Data

While captured data is shown, press the STORE button to save the captured data to internal memory. The captured data can be recalled at a later time by using the RECALL button. In addition, the EXPORT selection option can be used to transfer the captured data to a USB device via the File Navigator dialog box, or the web browser interface can be used to access the display capture. For more information on the File Navigator dialog box, see page 87. For more information on the web browser interface, see page 99.

Recalling Captured Data

While captured data is shown, press the **RECALL** button to recall captured data from internal memory via the File Navigator dialog box. For more information on the File Navigator dialog box, see page 87.

Clearing Captured Data

Press the **CLEAR** button to clear the frozen information in the frame. Once the frozen data is cleared from the frame, a new data capture can be performed.

Section 4 ♦ Operating the CMN-41

Overview

In the CMN-41, certain buttons function differently, depending on the parameters selected. Once the function is determined, more detailed settings can be configured. This section focuses on the operation of the CMN-41 according to the selected display. See **Figure 3-1** on page 16 for information about the location of the buttons described in this section. See Section 3 for general information on how the CMN-41 operates.

Waveform Display



Press and release the WFM function button to access the Waveform display. The waveform graticule scales, units of measure, and critical amplitude limits change according to the video format displayed.

Press and hold the WFM function button to access the Waveform Setup menu selection options. (Press the SETUP or the EXIT button to clear the Waveform Setup menu.)

Table 4-1 shows the Units of Measure that appear for a video format. **Table 4-2** lists the critical amplitude limits, which are indicated on the screen by special dashed lines for the video formats that can be displayed.

Table 4-1. Video Formats and Units of Measure

Video Format	Unit of Measure
High Definition and Standard Definition 525 and 625	Volts or Percent (Selectable)
High Definition 59.94 or 60, or Standard Definition 525 displayed as composite (NTSC)	IRE
High Definition 50 or Standard Definition 625 displayed as composite (PAL)	Units or Volts (Selectable)

Table 4-2. Video Formats and Critical Amplitude Limits

Video Format	Critical Amplitude Limits
High Definition and Standard Definition	0.6125 V = upper 75% chroma limit 0.525 V = 75% luminance limit 0.350 V = 50% point; black for color difference channels 0.0875 V = lower 75% chroma limit
Standard Definition 525 as Composite (NTSC)	7.5 IRE – black level

A waveform display is shown in **Figure 4-1** and described in **Table 4-3**. The figure shows the location for the various waveform display fields.

Figure 4-1. Waveform Display Diagram

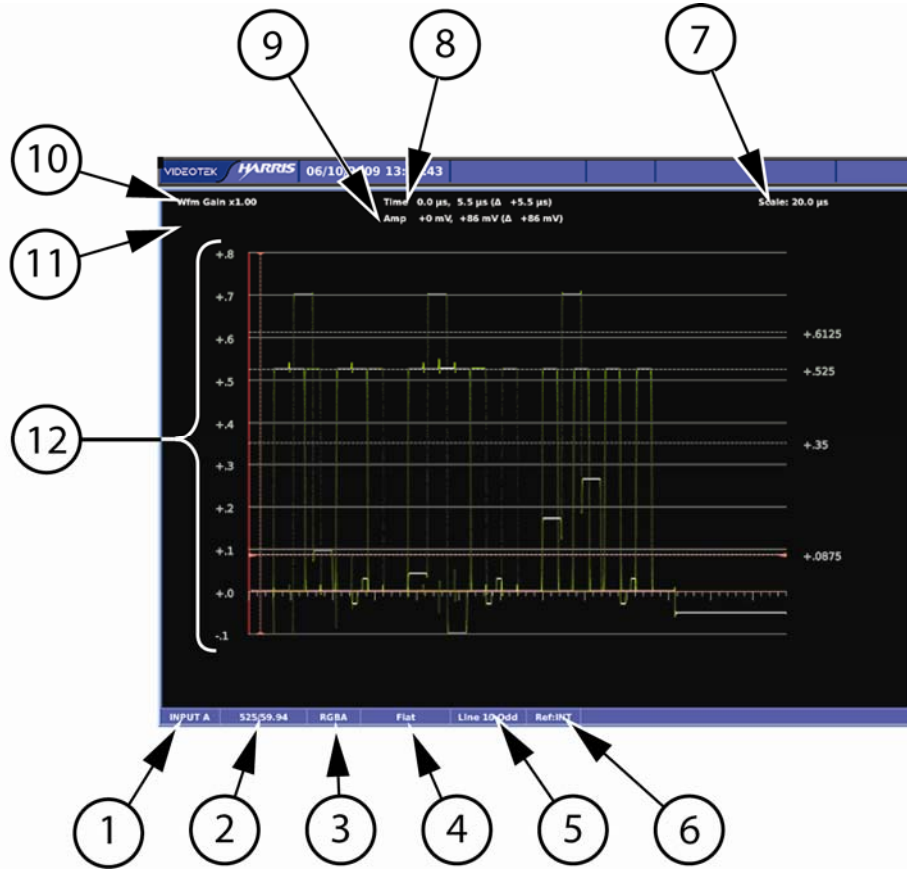

Table 4-3. Description of Waveform Display Diagram

Field Identifier	Field information	Nomenclature
1	Input	Displays selected input (A or B)
2	Standard	Displays the Line Rate/Frame Rate; this is selected in the Video Setup menu
3	Format	Displayed as YCbCr, RGB, YRGB, or Composite (CMPST); this can be selected in the Display/Format selection options of the Waveform Setup menu
4	Filter	For component displayed as Flat, Low Pass, or Bowtie For composite displayed as Flat, Low Pass, Chroma, or Flat and Low Pass This can be selected in the Composite or Component Filter selection options of the Waveform Setup menu
5	Line select information	Shown as Line number with the ODD or EVEN field (odd or even field will only show for interlaced Video Formats)
6	Reference	Displays the reference as INT, EXT (toggled by pressing the REF button)
7	Scale	Indicates the major graticule indications for time
8	Time cursor readout	Displays the time cursor as TIME and the selected numerical value followed by the unit or measure (μ s)
9	Amplitude cursor readout	Displays the amplitude cursor as AMP and the selected numerical value, followed by the unit or measure (mV, units, or IRE)
10	Gain	Displays the selected gain; Gain ranges are x0.5 to x15.0

Table 4-3. Description of Waveform Display Diagram

Field Identifier	Field information	Nomenclature
11	Zoom	Displays Zoom when enabled; blank when Zoom is disabled
12	WFM graticule	Shows the WFM RGB, YCbCr, or Composite graticule; the graticule is dependent upon the Video format, Zoom, and scale selections

Graticules are configured by selecting the Video Input Format along with the appropriate Waveform Setup scale adjustment (Units, %, or Volts). The scales can also change when the ZOOM button is pressed.

Figure 4-2 to **Figure 4-4** illustrate some waveform graticules with the critical amplitude limits for the video formats that can be displayed by the CMN-41. The critical amplitude limits are indicated on the screen by special dashed lines.

Figure 4-2. RGB and YCbCr Graticule

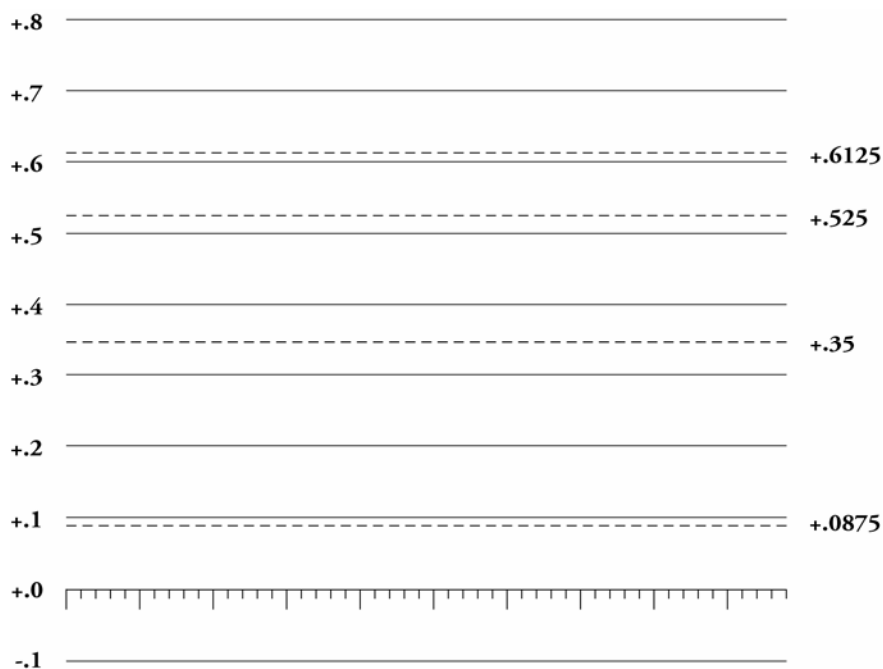

Figure 4-3. RGB and YCbCr Zoom 0 mV Graticule

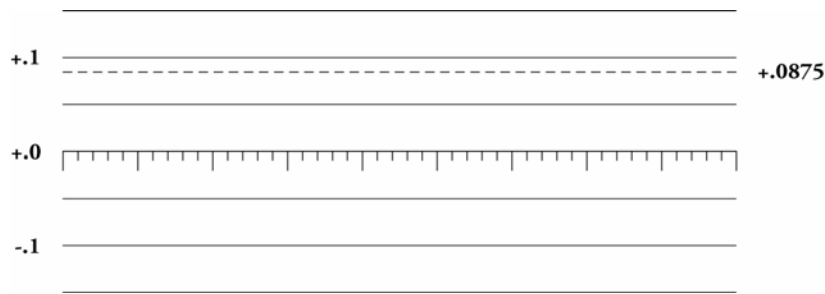

Figure 4-4. RGB and YCbCr Zoom 700 mV Graticule



Waveform Front Panel Selections

The following buttons directly affect the waveform display.

Moving the Waveform



Move the Waveform display relative to the graticule by selecting the POS button, and then using the Left and Right arrow knobs (for horizontal movement) and the Up and Down knob (for vertical movement).

Scroll the Left/Right (horizontal direction) or Up/Down (vertical direction) arrow knob to move the waveform in the particular direction. Press the Left/Right or Up/Down arrow knobs to center the waveform.

Selecting Horizontal or Vertical Sweep



Press the H/V button to select one of the horizontal sweep modes or to toggle between horizontal and vertical sweep modes.

Figure 4-5. Sample H/V Display

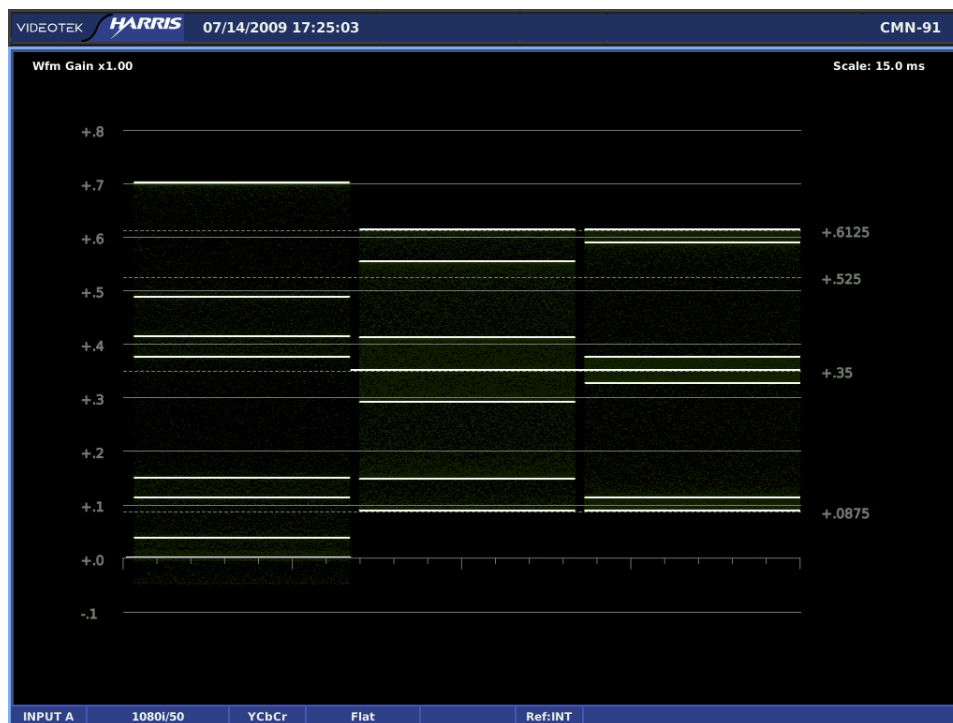

Setting the Vertical and Horizontal Amplification Range



Gain is used to set the range of the vertical and horizontal amplification in the video signal. The standard gain in the video signal is x1.

The CMN-41 can be used to set the gain amplification in the video signal using the Gain button. The vertical gain setting appears in the upper-left portion of the waveform display, as shown in **Figure 4-6**. The horizontal gain setting appears in the upper-right portion of the waveform display.

Vertical Amplification

Press and release the Gain button, and then use the Up/Down arrow knob to scroll through the gain selection range, or press the Up/Down arrow knob to select one of the preset gain selections (x0.5, x1.0, x2.5, x5.0).

Horizontal Amplification

Press and release the Gain button, and then press the Left/Right arrow knob to cycle through the horizontal gain sequence of x1.0, x5.0, x10.0, and back to x1.0. When vertical sweep is selected, the gain sequence changes to x1.0, x5.0, and x25.0.

Figure 4-6. Establishing the Gain

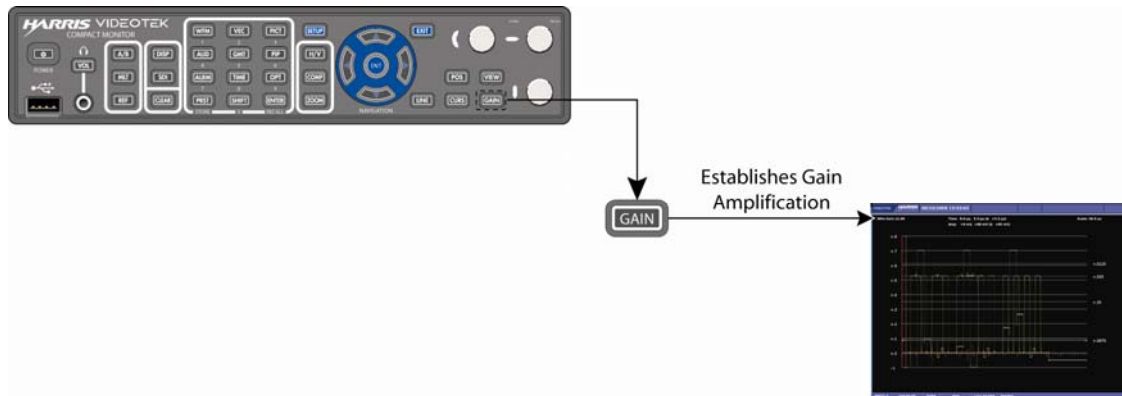

Selecting Components



Press and release the COMP button to step through single or multiple components in a signal.

When multiple components are selected, use the H/V button to toggle between 1H and 1V. With only one component selected, press the H/V button to toggle between 1H and 1V, or 2H and 2V.

Selecting Display Options

Press and release the ZOOM button to cycle through these display options:



- ZOOM positioned on the 0 IRE, 0 mV, or 0% graticule line
- ZOOM positioned on the 100 IRE or 700 mV, or 100% graticule line
- Normal view

At each zoom position, the graticule scale and waveform displays expand to provide more resolution around the zoom point.

Placing the Waveform Display in Line Select Mode



Press and release the LINE button to enable the monitoring of a single line of a video signal. To view a line in Line Select mode:

1. Press the LINE button to place the selected waveform display in Line Select mode. At the bottom-center of the display, the Line number and the Odd or Even field appear, as shown in **Figure 4-7**.

Figure 4-7. Establishing Line Select

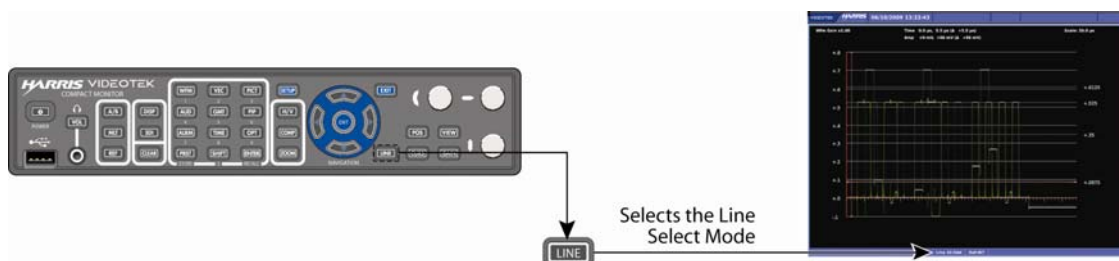

NOTE: In a Progressive (p) format, odd and even selections are not available.

9. Press the Up/Down arrow knob to alternate between Odd and Even fields.
10. Rotate the Up/Down arrow knob to select the line to be displayed, or press the SHIFT function button to use the numeric keypad to enter the line number.

Waveform Cursor Selections



Cursor indications are available for precise measurement of waveform voltage and waveform time. The cursor indications appear at the top of the display. The Time Cursor indication is identified as TIME, and the Amplitude Cursor indication is identified as AMP, as shown in **Figure 4-8**.

Figure 4-8. Establishing Cursor Select

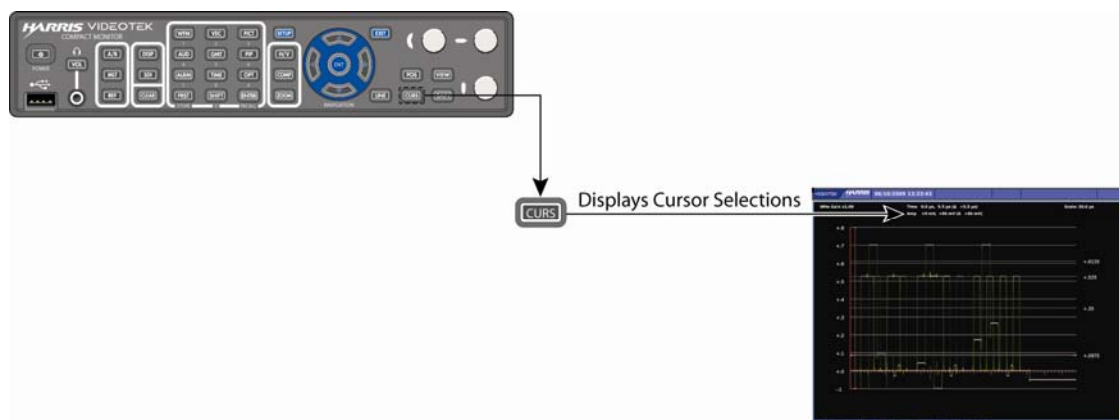

To enable the time and amplitude cursor indications, press and release the CURS button. Press the CURS button again to disable the cursor indications.

- To select the TIME cursor, press the Left/Right arrow knob to select the REF cursor. Press the arrow knob again to select the DELTA cursor. Press the arrow knob again to select both cursors.
- To select the AMP cursor, press the Up/Down arrow knob to select the REF cursor. Press the arrow knob again to select the DELTA cursor. Press the arrow knob again to select both cursors.

In all cases, the TIME and AMP numeric readout at the top of the display indicates the difference between the REF and DELTA cursors. The active cursor (REF, DELTA, or both) is shown with small arrows at both ends of the cursor.

To exit the cursor function while leaving the cursors active, press the WFM button or select another mode in the display (that is, LINE, GAIN, or POS).

Waveform Setup Menu

Press and hold the WFM function button to access the Waveform Setup menu. For more information on the Waveform Setup menu, see page 66. For descriptions of Waveform Setup menu selection options, see page 75.

Vector Display



Press and release the VEC function button to access the vector display. A vector display is shown in **Figure 4-9** and described in **Table 4-4**. This illustrates the general location for the various vector fields.

Press and hold the VEC function button to access the Vector Setup menu selection options. (Press the SETUP or the EXIT button to clear the Vector Setup menu.)

Figure 4-9. Vector Display Diagram

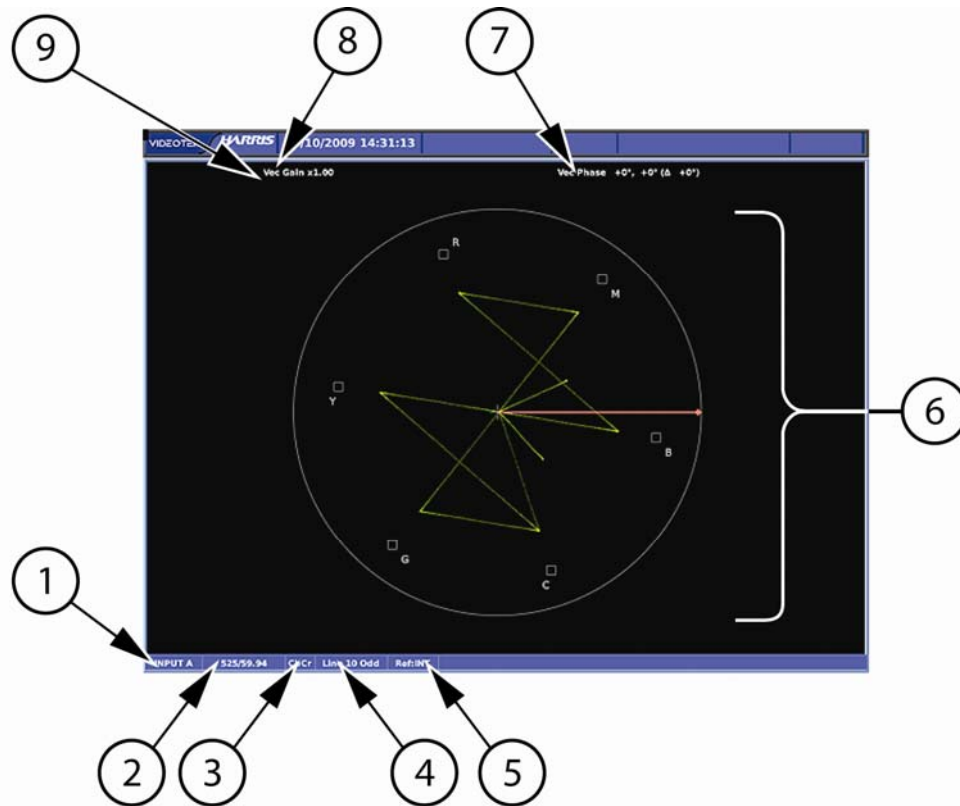

Table 4-4. Description of Vector Display Diagram

Field Identifier	Field Information	Nomenclature
1	Input	Displays selected input (A or B)
2	Standard	Shown as line rate/frame rate; this can be selected in the Video Setup menu
3	Format	Displayed as CbCr; this can be selected in the Vector Setup menu
4	Line select information	Shown as Line and the number with the Odd or Even field (Odd or even Field will only show for certain video formats)
5	Reference	Displays the reference as INT, EXT (toggled by pressing the REF button)
6	Vector graticule	Shown as Vector graticule
7	Phase cursor readout	Displays phase cursor as VEC PHASE and number in degrees
8	Gain	Displays the selected gain; gain ranges are x0.5 to x15.0
9	Zoom	Shown as Zoom (when enabled); blank when disabled
Not shown	Vector Standard	Displayed as 75%, 100%, or 75% + 100%; this is set in Standard selection option of the Vector Setup menu

Graticules are configured by selecting the Video Input Format along with the appropriate Vector Setup standard.

Some graticule scales are illustrated in **Figure 4-10** to **Figure 4-17**.

Figure 4-10. Vector NTSC Graticule

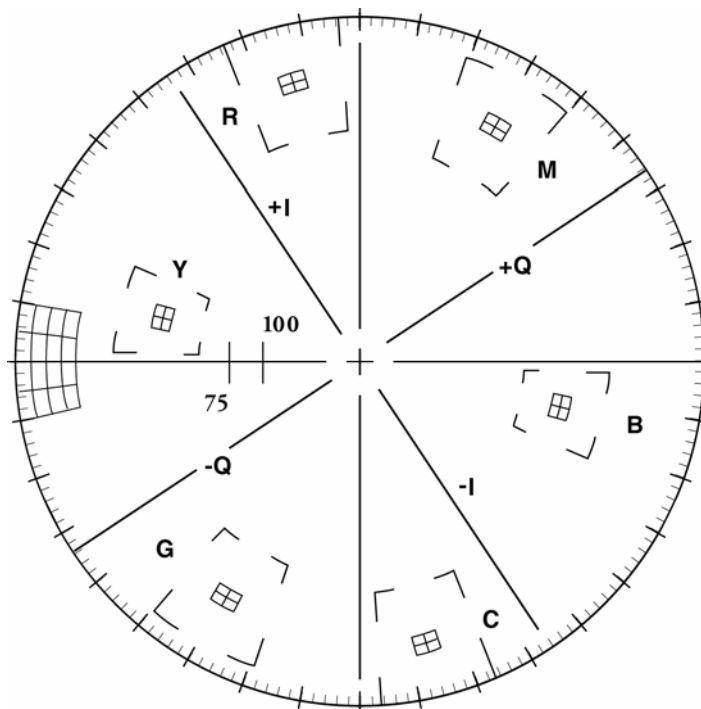

Figure 4-11. Vector NTSC Zoom Upper Left

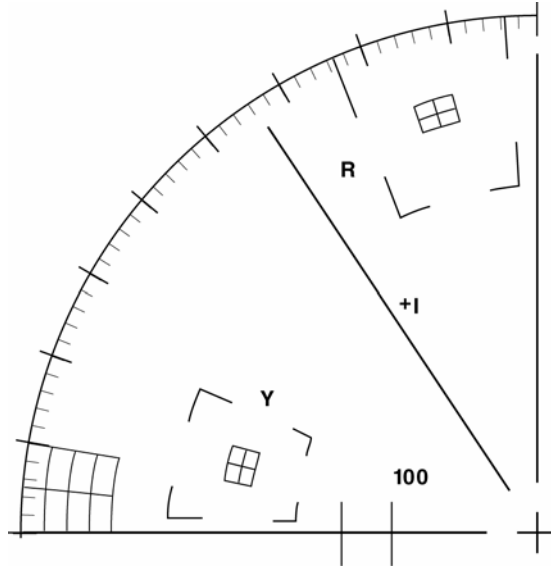

Figure 4-12. Vector NTSC Zoom Upper Right

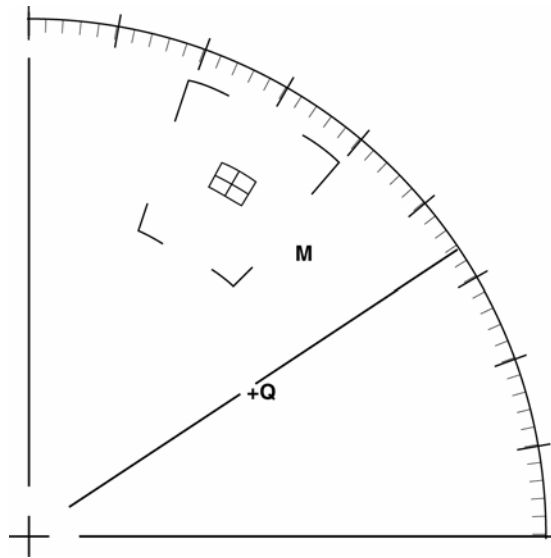

Figure 4-13. Vector NTSC Zoom Lower Right

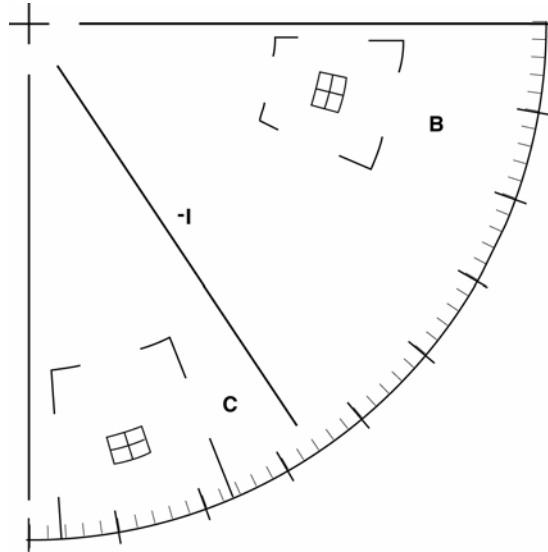

Figure 4-14. Vector NTSC Zoom Lower Left

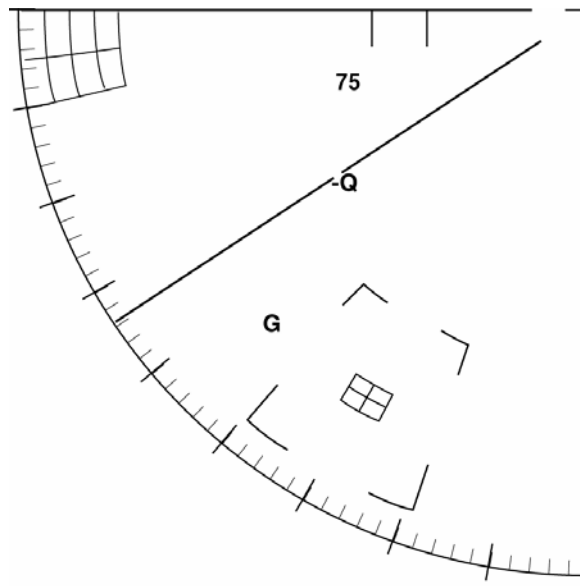

Figure 4-15. Vector PAL Zoom Center

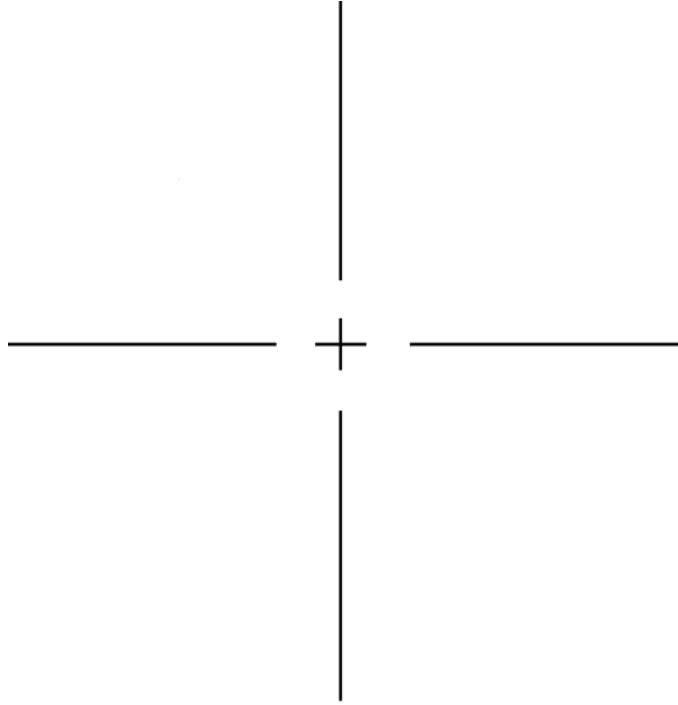

Figure 4-16. Vector SD with I/Q

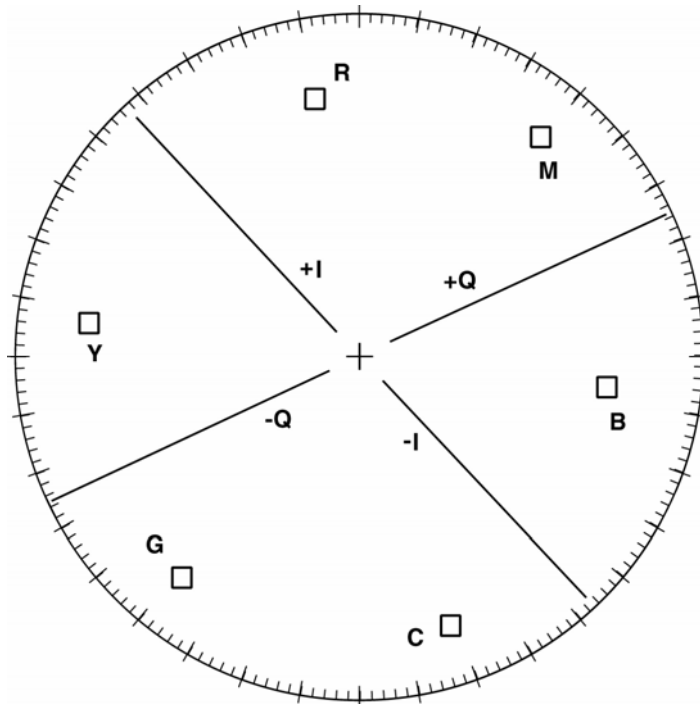
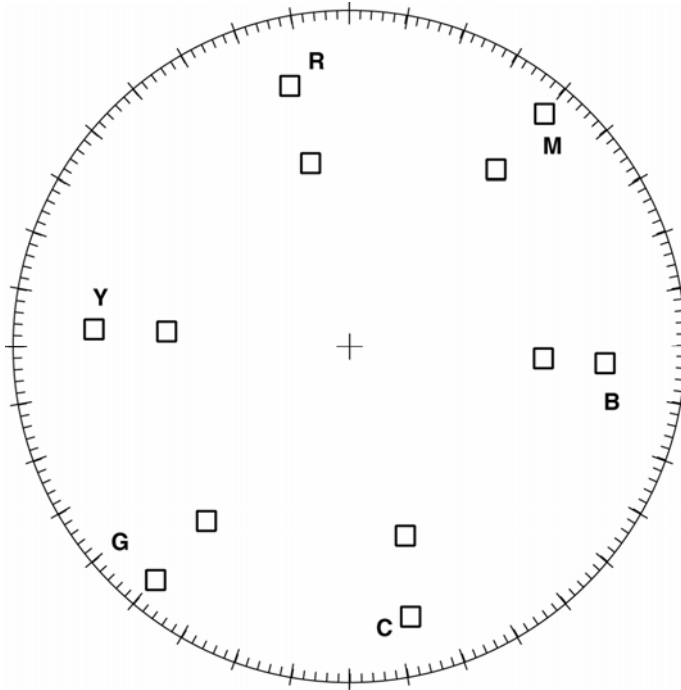

Figure 4-17. Vector HD 75% + 100% Graticule



Vector Front Panel Selections

The following buttons directly affect the vector display.

Setting the Vector Gain

Gain is used to set the range of the amplification in the video signal. The standard gain in the vector is x1.0. The CMN-41 can be used to set the gain amplification in the video signal using the Gain button. The gain setting appears in the upper-left portion of the vector display, as shown in **Figure 4-18**.



Press and release the Gain button, and then use the Up/Down arrow knob to scroll through the gain selection range, or press the Up/Down arrow knob to select one of the preset gain selections (x0.5, x1.0, x2.5, x5.0).

Figure 4-18. Establishing the Vector Gain

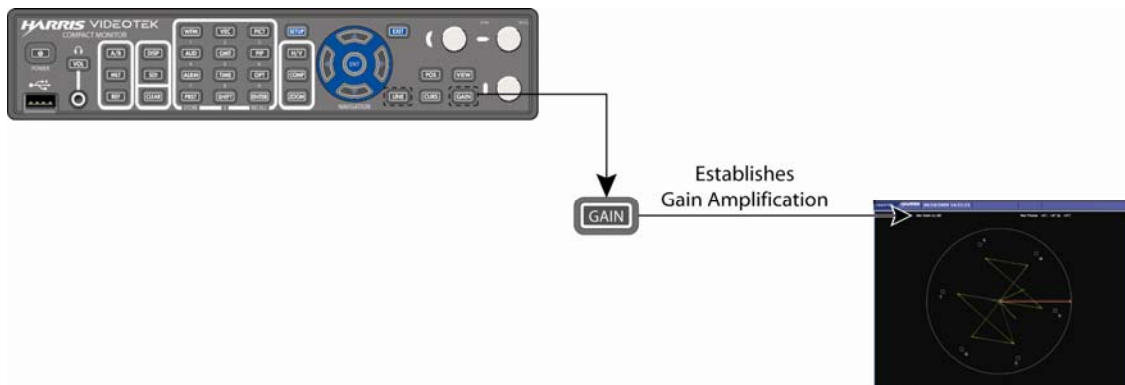

Setting Display Options



Press the ZOOM button to cycle through these display views:

- Expand the center
- Expand the upper-left quadrant
- Expand the upper-right quadrant
- Expand the lower-right quadrant
- Expand the lower-left quadrant
- Normal view

Vector Zoom is helpful when an increased resolution of phase or saturation is required.

Placing the Vector Display in Line Select Mode



Pressing the LINE button enables monitoring of a single line of a video signal. This enables Line Select to monitor individual areas of the entire image. To view a line in Line Select mode:

1. Press the LINE button to place the selected vector display in Line Select mode. At the bottom-center of the display, the Line number and the Odd or Even field appear, as shown in **Figure 4-19**.

Figure 4-19. Establishing Line Select

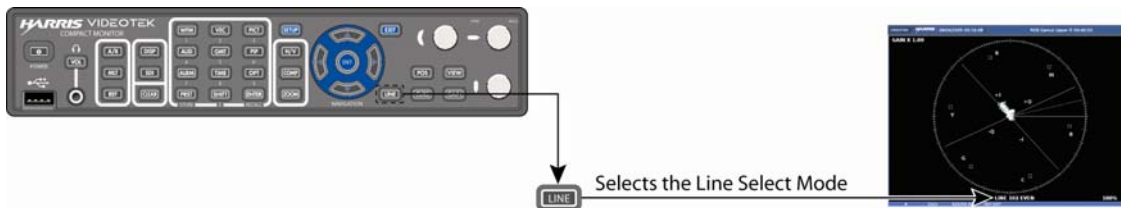

NOTE: In a Progressive (p) format, odd and even selection is not available.

2. Press the Up/Down arrow knob to alternate between Odd and Even fields.
3. Rotate the Up/Down arrow knob to select the line to be displayed, or press the SHIFT function button to use the numeric keypad to enter the line number.

Vector Cursor Selections



Cursors are available for precise measurement of vector phase (in degrees). Press the CURS button on the front panel to enable the cursors for the selected display. The Phase Cursor indications are shown in **Figure 4-20**.

Figure 4-20. Establishing Cursor Select

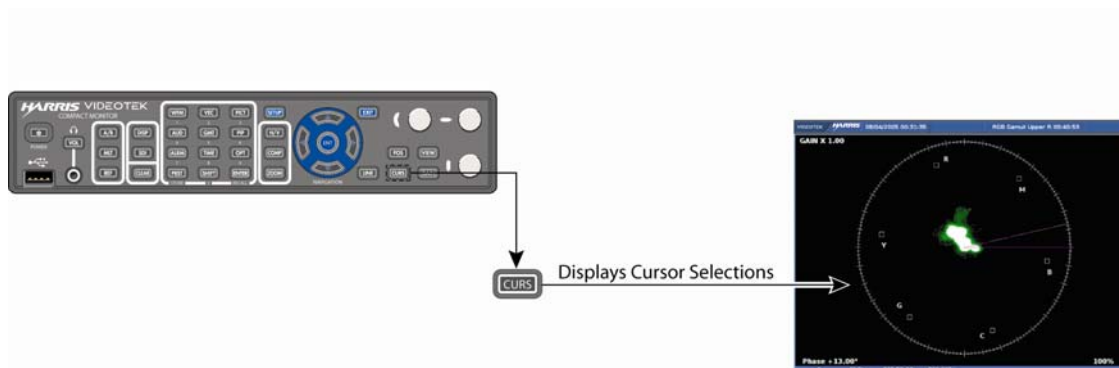

To enable the Phase cursors, press and release the CURS button. Press the CURS button again to disable the cursor information.

When the cursor is selected, the Phase indication appears at the top of the display. Next to the Phase indication is a numeric readout that indicates the difference between the REF and DELTA lines. The active cursor (REF, DELTA, or both) is shown with small arrows at the outer end of the line.

To select a cursor line for control:

1. Press the curved arrow knob to select the REF or DELTA line to control. The REF line is the solid line, and the DELTA line is the dotted line.
2. Rotate the curved arrow knob to move the REF or DELTA line to the desired location.
3. Press the curved arrow knob for the next cursor. Rotate the knob to move the cursor to the desired location.
4. Press the curved arrow knob a third time to control both the REF and DELTA lines.
5. Repeat as necessary.

Once the cursors are no longer necessary, press and release the CURS button to disable the Phase cursor selection.

To exit the cursor function while leaving the cursor active, press the VEC function button or select another mode (that is, LINE, GAIN, or POS)

Vector Setup Menu

Press and hold the VEC function button to access the Vector Setup menu. For more information on the Vector Setup menu, see page 67. For descriptions of Vector Setup menu selection options, see page 77.

Gamut Display

A constant setback in video production is the difference between the allowable ranges of dissimilar component and composite color spaces. Combinations of values that are within the range of a color-difference component video system produce signal amplitudes outside the ranges when the signal is transcoded to composite or RGB color space.



Press and release the GMT function button to access the Gamut display. The Gamut displays show RGB limits or composite video limits.

Press and hold the GMT function button to access the Gamut Setup menu selection options. (Press the SETUP or the EXIT button to clear the Gamut Setup menu.)

Both Gamut displays illustrate what colors are causing illegal excursions and whether these digressions are above or below the allowable limits. The inputs are shown as an encoded display with gamut alarms. The displays show RGB and composite video limits.

Vector excursion marks are shown in the gamut display. The excursion marks help to visualize the minimum/maximum value of a 100% color bar signal. The position of the excursion marks depend on the selected Video Format selection from the Video Setup menu.

A gamut display diagram is shown in **Figure 4-21** and described in **Table 4-5**. The diagram illustrates the general location for the various gamut fields.

Figure 4-21. Gamut Display Diagram

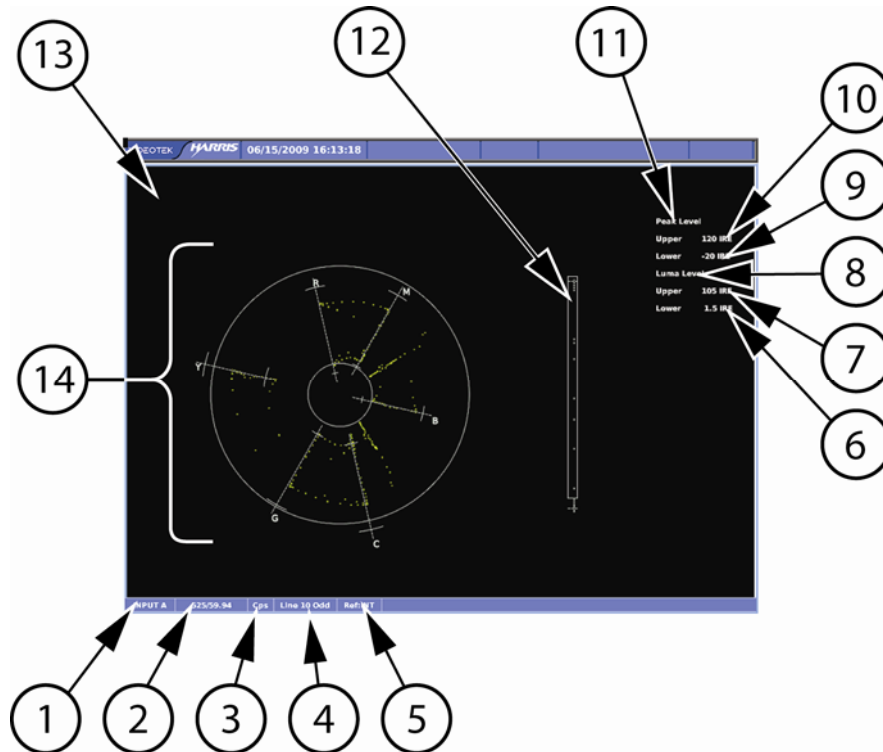

Table 4-5. Description of Gamut Display Diagram

Field Identifier	Field Information	Nomenclature
1	Input	Displays selected input (A or B)
2	Standard	Displays the Line Rate/Frame Rate [1080i/59.94]; this is selected in the Video Setup menu
3	Format	Displayed as Cps and RGB; this can be selected in the Gamut Setup menu

Table 4-5. Description of Gamut Display Diagram

Field Identifier	Field Information	Nomenclature
4	Line select information	Shown as Line and the number with the Odd or Even field (when applicable)
5	Reference	Displays the reference as INT, EXT (toggled by pressing the REF button)
6	Lower luma alarm limit (Composite only)	Displayed as Lower = xxx yy; xxx is the Luma lower threshold setting and yy is determined by the format (IRE for NTSC and Units or mV for PAL)
7	Upper luma alarm limit (Composite only)	Displayed as Upper = xxx yy; xxx is the Luma upper threshold setting and yy is determined by the format (IRE for NTSC and Units or mV for PAL)
8	Luma alarm limit	Displays Luma when Composite is selected; this field is blank when Single Color or RGB is selected
9	Lower chroma alarm limit	Displayed as Lower = xxx yy <ul style="list-style-type: none"> For RGB xxx is the s the RGB Gamut lower threshold setting, and yy as units For Composite, xxx is the Peak lower threshold setting In Composite, yy is determined by the format (IRE for NTSC and Units for PAL)
10	Upper chroma alarm limit	Displayed as Upper = xxx yy <ul style="list-style-type: none"> For RGB, xxx is the RGB Gamut upper threshold setting and yy is shown as mV For Composite, xxx is the Peak upper threshold setting In Composite, yy is determined by the format (IRE for NTSC and Units or mV for PAL)
11	Chroma alarm limits	Displayed as RGB (for RGB or Single Color) and PEAK (for Composite)
12	Luma/Mono bar graticule	Shows the Luma/Mono bar graticule
13	Zoom	Zoom when enabled; blank when disabled
14	Gamut Graticule	Composite or RGB Gamut graticule

Composite Gamut

The graticule for the composite gamut vector, as shown in **Figure 4-22** and described in **Table 4-6**, is two concentric circles with other identifiers. When setting the upper and lower limits, the upper and lower gamut rings represent the values set from the threshold values of the appropriate format. To move the gamut rings, set the ALARMS → VIDEO → GAMUT → PEAK GAMUT UPPER (or LOWER) → THRESHOLD 525/59.94 or THRESHOLD 625/50 selection option. To move the luma bar limits, set the ALARMS → VIDEO → GAMUT → LUM GAMUT UPPER (or LOWER) → THRESHOLD 525/59.94 or THRESHOLD 625/50 selection option. The outer circle (the upper gamut alarm limit) represents the highest allowable amplitude in standard composite units (that is, IRE for NTSC and units for PAL). The inner circle (the lower gamut alarm limit) represents the lowest allowable amplitude. The rings turn red when the alarm is enabled and the values exceed the threshold setting.

The other identifiers are radials that extend at the angle of the designated color. These six lines follow the same displacement as the vector display. Note that since the PAL display is derived solely from component information, there are not two phases for PAL signals. The +V phase is used (making the vectors look similar to NTSC).

NOTE: There is an alarm persistence of two seconds associated with any alarm indication. After an alarm has cleared, two seconds will pass before the gamut alarm indicator returns to normal.

Figure 4-22. Composite Gamut Vector Display Graticule Markings

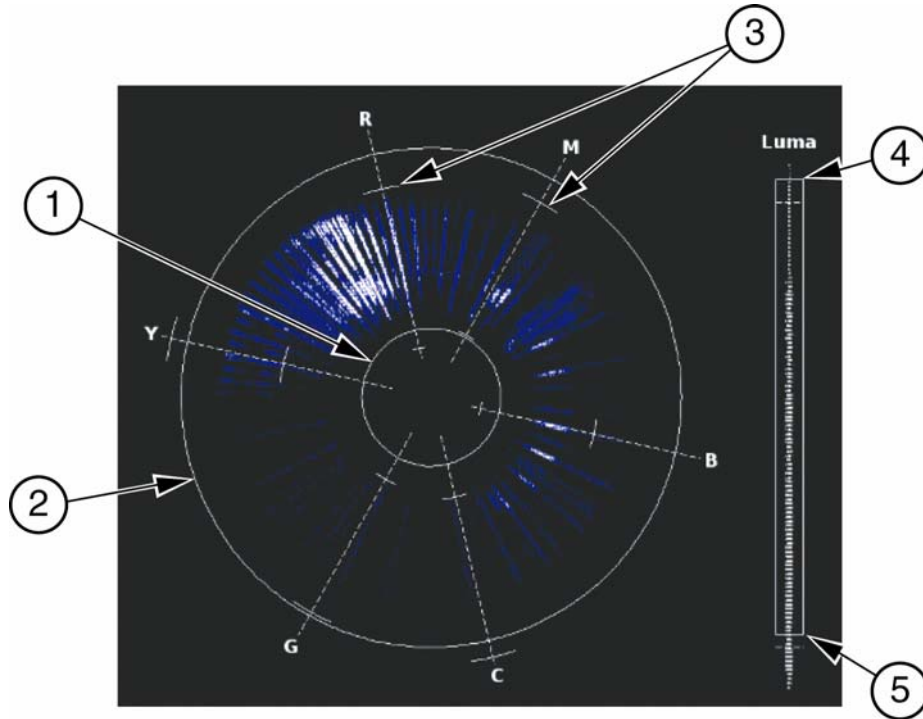

Table 4-6. Description of Composite Gamut Indicators

Key	Indicator	Description
1	Lower Gamut Ring	The lower gamut ring indicates the Gamut alarm Peak Lower limit. When the Gamut alarm is enabled and the Peak Lower limit is exceeded, the lower gamut ring turns red.
2	Upper Gamut Ring	The upper gamut ring indicates the Gamut alarm Peak Upper limit. When the Gamut alarm Peak Upper limit is exceeded, the upper gamut ring turns red.
3	Vector Excursion Mark	The excursion marks help to visualize the minimum/maximum value of 100% color bars.
4	Luma Upper Limit Line	The Luma Upper Limit Line indicates the Gamut alarm Luma Upper limit. When the Gamut alarm is enabled, and the Luma Upper limit is exceeded, the luma upper limit line and LUMA turn red.
5	Luma Lower Limit Line	The Luma Lower Limit Line indicates the Gamut alarm Luma Lower limit. When the Gamut alarm is enabled, and the Luma lower limit is exceeded, the Luma Lower Limit line and LUMA turn red.

RGB Gamut Display

When setting the upper and lower limits, the upper and lower gamut rings represent the threshold values. To move the gamut rings, set the ALARMS → VIDEO → GAMUT → RGB GAMUT UPPER (or LOWER) → THRESHOLD selection option. The RGB Gamut Display, shown in **Figure 4-23** and described in **Table 4-7**, is similar to the Composite Gamut Display. The RGB Gamut vector displays video amplitudes

(which are in mV) in a polar format to represent color information. The rings turn red when the alarm is enabled and the values exceed the threshold setting.

Each R, G, and B pixel is plotted using amplitude and phase. The amplitude is derived from the R, G, B component. The phase is derived from the CB CR information of the digital signal. The pixels can be plotted as a single color or as each component color (see **Table 5-8** on page 67). Unlike the composite Gamut vector, which plots two points per pixel, the RGB Gamut vector plots three points. Also, signals with no color content are displayed on a separate bar graph labeled Mono.

The RGB graticule is nearly identical to the composite graticule. The only differences are

- Amplitudes are displayed in mV rather than IRE or UNITS.
- The radials representing color vectors are 60° apart since they are displayed in a component color space.
- Mono bar graph is for monochrome.

NOTE: There is an alarm persistence of two seconds associated with any alarm indication. After an alarm has cleared, two seconds will pass before the gamut indicator returns to normal.

Figure 4-23. Component (RGB) Gamut Vector Display Graticule Markings

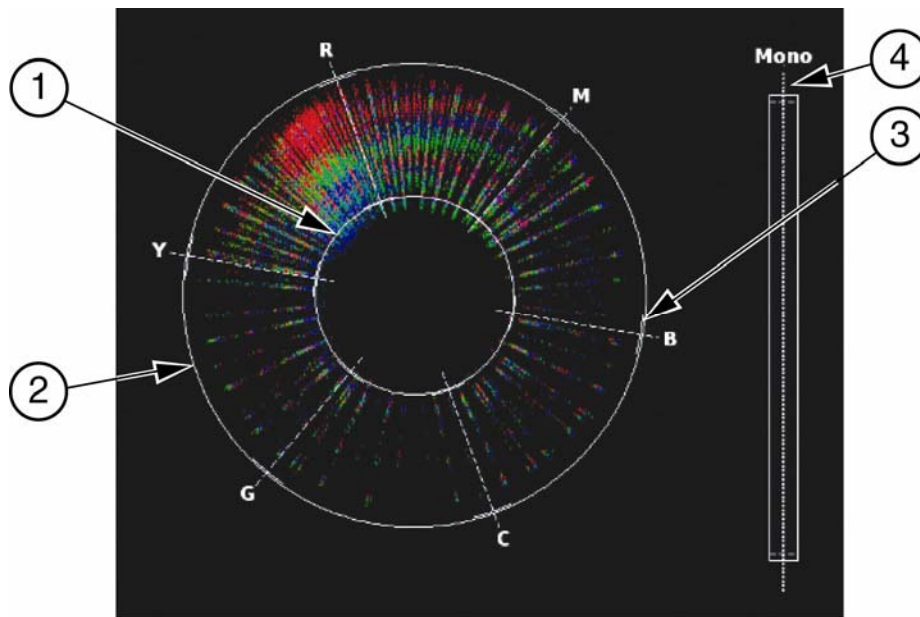

Table 4-7. Description of RGB Gamut Indicators

Key	Indicator	Description
1	Lower Gamut Ring	The lower gamut ring indicates the RGB Gamut alarm Lower limit. When the RGB Gamut alarm is enabled and the Lower limit is exceeded, the lower gamut ring turns red.
2	Upper Gamut Ring	The upper gamut ring indicates the RGB Gamut alarm Upper limit. When the RGB Gamut alarm is enabled, and the Upper limit is exceeded, the upper gamut ring turns red.
3	Vector Excursion Mark	The excursion marks help to visualize the minimum/maximum values of 100% color bars.
4	Mono	Mono indicates the monochrome of the RGB signal. There is no alarm associated with Mono.

Placing the Gamut Display in Line Select Mode



Press the LINE button to enable monitoring of a single line of a video signal. This enables Line Select to monitor individual lines of the entire image.

To view a line in Line Select mode:

1. Press the LINE button to place the selected Gamut display in Line Select mode. At the bottom of the display, the Line number and Odd or Even field appear, as shown in **Figure 4-24**.

Figure 4-24. Establishing Line Select

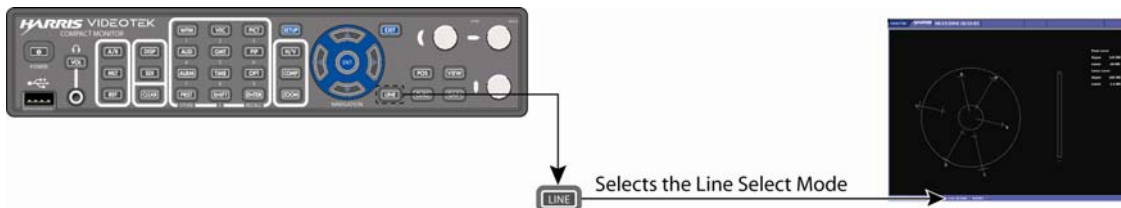

NOTE: In a Progressive (p) format, Odd and Even selections are not available.

2. Press the Up/Down arrow knob to alternate between the Odd and Even fields for interlaced formats.
3. Rotate the Up/Down arrow knob to select the line to be displayed.

Setting Display Options



Press and release the ZOOM button to cycle through the displays of the Composite or RGB gamut graphicule:

- Expand the center
- Expand the upper-left quadrant
- Expand the upper-right quadrant
- Expand the lower-right quadrant
- Expand the lower-left quadrant
- Normal view

Gamut Setup Menu

Press and hold the GMT function button to access the Gamut Setup menu. For more information on the global Gamut Setup menu, see page 67. For descriptions of Gamut Setup menu selection options, see page 78.

Picture Display



The Picture Display is used to show the picture of the selected input. Press and release the PICT function button to display the picture. A Picture display diagram is shown in **Figure 4-25** and described in **Table 4-8**. Only one picture can be displayed.

Press and hold the PICT button to access the Picture Setup menu. (Press the SETUP or the EXIT button to clear the Picture Setup menu.)

NOTE: Pictures can be used as thumbnails. For more information, see page 77.

Figure 4-25. Picture Display Diagram

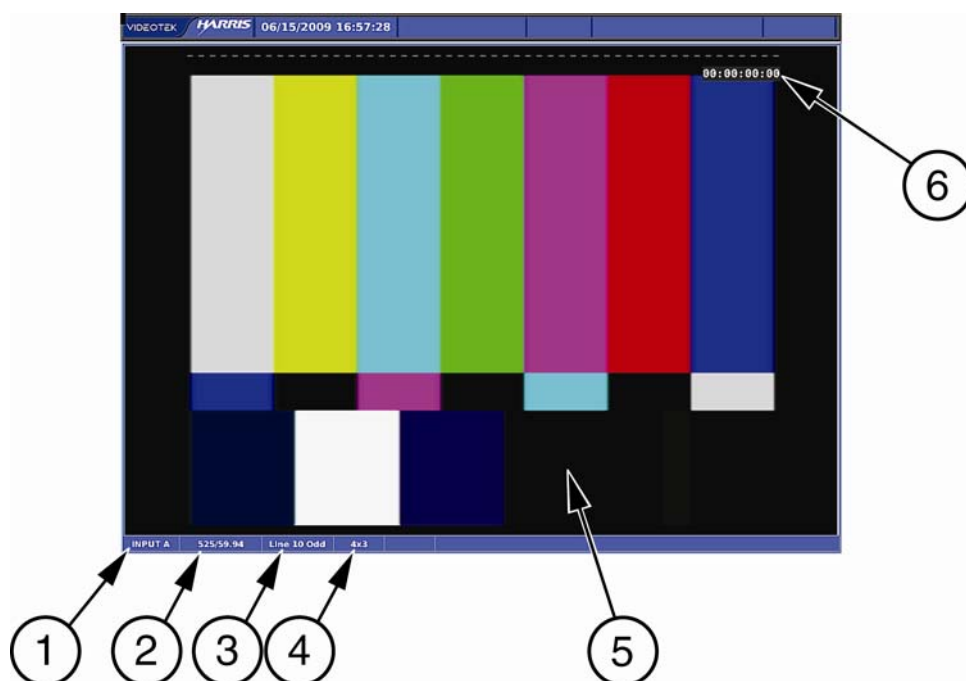
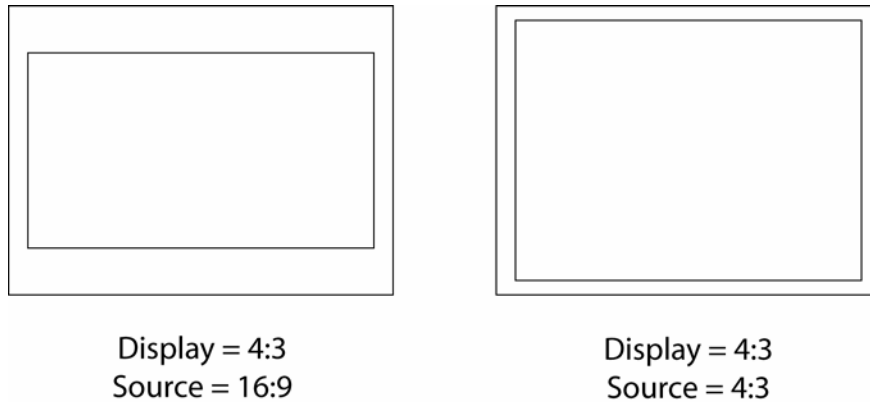

Table 4-8. Description of Picture Display Diagram

Field Identifier	Field Information	Nomenclature
1	Input	Displays selected input (A or B)
2	Standard	Displays the line rate/frame rate; select the Standard in the Video Setup menu
3	Line select information	Shown as Line and the number with the Odd or Even field (when applicable)
4	Aspect ratio	Displays the selected aspect ratio; select the aspect ratio in the Unit Configuration Setup → Display Setup selection option
5	Picture	Displays picture of the selected video input
6	Timecode	Displays location of the timecode information when timecode is enabled

The picture display changes according to the aspect ratio and anamorphic selections in the global Setup menu. A picture display diagram, shown as the left drawing in **Figure 4-26**, shows the 4:3 display with a 16:9 source. Also, the picture to the right in **Figure 4-26** shows a 4:3 display with a 4:3 source.

Figure 4-26. Aspect Ratio Source Diagram



Placing the Picture in Line Select Mode



To enable Line Select mode:

1. Press the LINE button to place the selected Picture display in Line Select mode. A cursor appears on the selected line, as shown in **Figure 4-24**.

Figure 4-27. Establishing Line Select

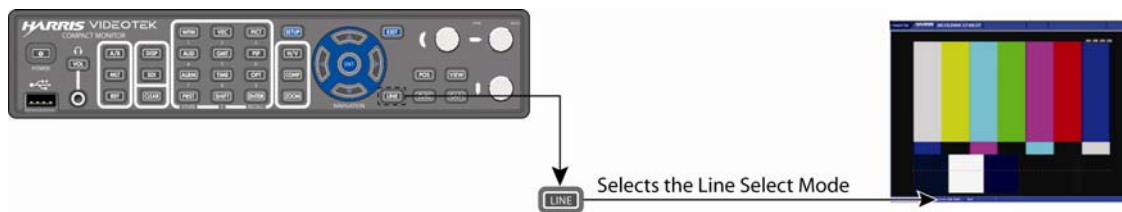

NOTE: In a Progressive (p) format, Odd and Even selections are not available.

2. Press the Up/Down arrow knob to alternate between the Odd and Even fields for interlaced formats.
3. Rotate the Up/Down arrow knob to select the line to be displayed.

Picture Setup Menu

Press and hold the PICT function button to access the Picture Setup menu. For more information on the global Picture Setup menu, see page 67. For descriptions of Picture Setup menu selection options, see page 77.

PIP Display

The Picture-In-Picture (PIP) function shows a “thumbnail” of the selected input’s picture display, with the selected function display information appearing in the background. The PIP function is available with the waveform, vector, gamut, audio, alarm, time, and options functions.



While in the active display, press and release the PIP function button to enable the picture-in-picture display.

Figure 4-28 shows the PIP function enabled in Overlay Display mode, along with the waveform and vector displays.

Figure 4-28. Sample PIP Display

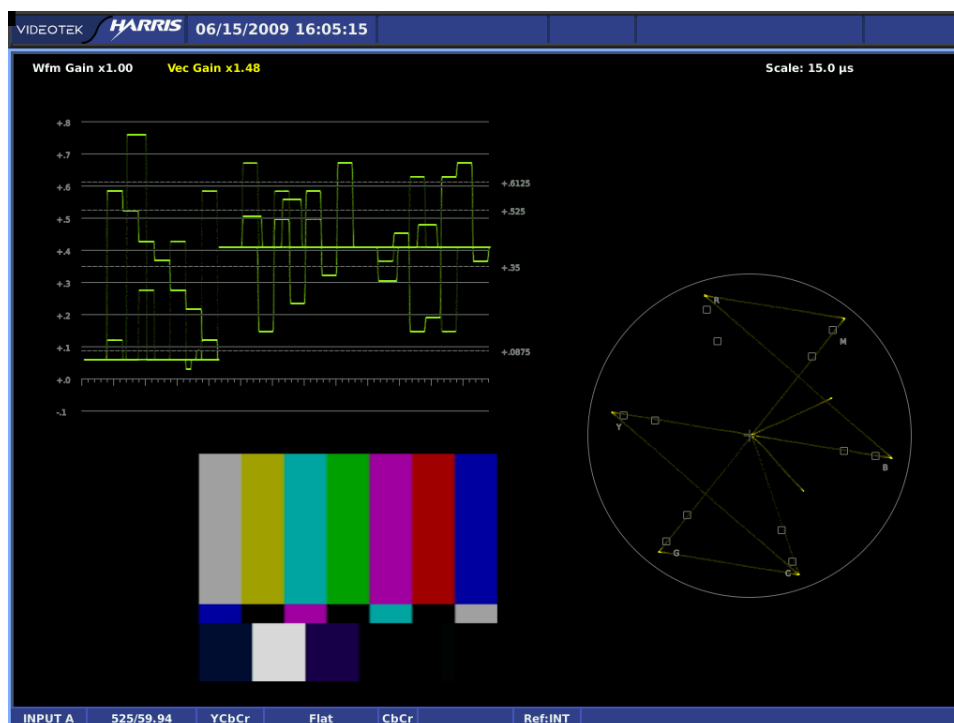

Moving a PIP

To move a PIP, make sure the PIP function button and the VIEW button are in high tally. Use the Up/Down and Left/Right arrow knobs to reposition the PIP on the display.

Scaling a PIP

To scale a PIP display's size, make sure the PIP function button and the VIEW button are in high tally. Use the curved arrow knob to resize the PIP on the display.

Removing a PIP

To remove a PIP from the display, make sure the PIP function button is in high tally, and then press the PIP function button. The display disappears from the screen.

Audio Display



Press and release the AUD function button to display the audio display. The CMN-41 accepts one AES/EBU and up to four groups of embedded audio inputs. Any two input channels can be selected to be monitored on the headphone output.

Press and hold the AUD function button to access Audio Setup menu selection options.

Configure the audio display type and parameters using the Audio → Channel selection options. Audio can be displayed as one of the following:

- One two-channel bar graph with one Lissajous and one Phase bar
- Two two-channel bar graphs (for a total of four channels) with two Lissajous and two Phase bars
- Three two-channel bar graphs (for a total of six channels) with three Phase bars or CineSound 5.1 with two Phase bars
- Four two-channel bar graphs (for a total of eight channels) with four Phase bars or CineSound 5.1+AUX, 6.1, or 7.1 with up to three phase bars
- Eight two-channel bar graphs (for a total of sixteen channels) with eight Phase bars

Lissajous can be selected as Soundstage or X-Y displays.

Input assignments, scaling, input levels, and response can also be modified using the Audio Setup menu.

Audio Scales

The Vertical audio graticule scales change according to the selections made in the Audio → Meter Setup → Scale selection options. The Scale selection options are as follows:

- | | |
|--------------|-----------------|
| • Type I | • DIN 45406 |
| • Type IIA | • dBFS |
| • Type IIB | • Zero Ref dBFS |
| • Type I + 8 | • Custom dBFS |
| • Nordic | • Custom dB |

Vertical Audio Displays

Vertical Audio display diagrams are shown in **Figure 4-29** to **Figure 4-32**, and described in **Table 4-9** to **Table 4-12**. The Vertical audio graticule scales change according to the scale selections made in the Setup menu.

Figure 4-29. Two Bar Graph Display with Lissajous Diagram

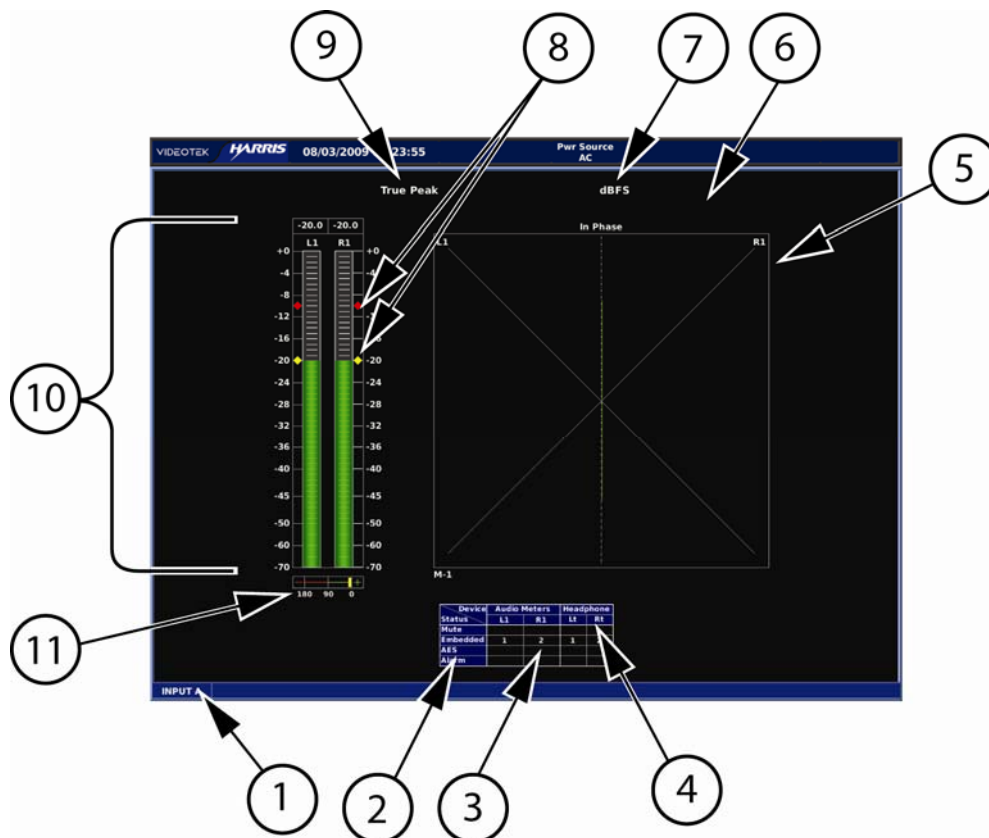

Table 4-9. Description of Two Bar Graph Display with Lissajous Diagram

Field Identifier	Field Information	Nomenclature
1	Input	Displays selected input (A or B)
2	Status	Displays audio type as Mute, AES, or Embedded Displays audio clip or mute alarm indicators
3	Channel Number	Shown as 1-16 (AES is 1-2 and Embedded is 1-16)
4	Device	Displays labels for lissajous, bar graphs, and headphone outputs
5	Lissajous Display	Lissajous of bar graph 1 with labels for R, L, and the number of the meter being monitored (for example, M-1)
6	Zoom	Zoom when enabled; blank when disabled
7	Scale Selection	Displays the selected meter scale: Type I, Type IIa, Type IIb, Type I + 8, Nordic, DIN 45406, dBFS, Zero REF dBFS, Custom dB, and Custom dBFS
8	Level Markers	Shows peak levels for the signal; this can be adjusted in the Audio → Meter Setup selection options
9	Meter Response	Displays the selected meter response: VU, Peak, True Peak, VU + Peak, VU + True Peak, Custom
10	Audio Graticule (with meter labels)	Shown as stereo pairs (L1, R1), SMPTE 320M, or custom label
11	Phase Bar	Phase Meter of bar graph 1

Figure 4-30. Four Bar Graph with Lissajous Display Diagram

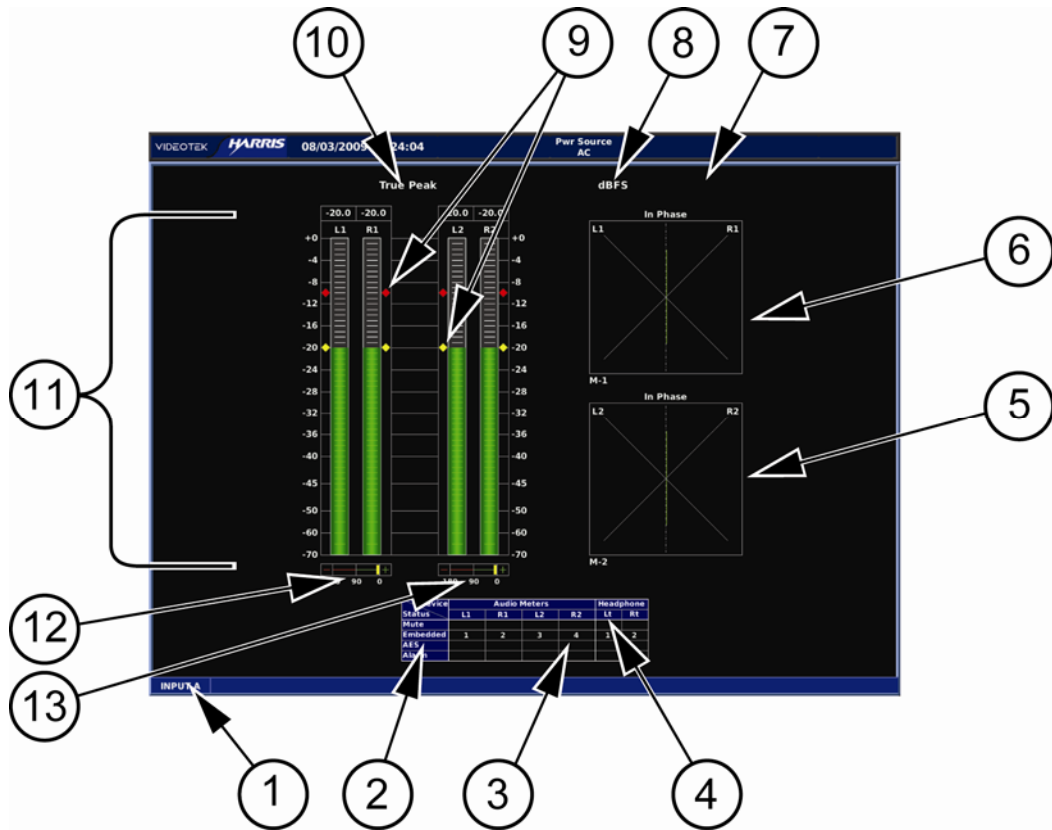

Table 4-10. Description of Four Bar Graph with Lissajous Display Diagram

Field Identifier	Field Information	Nomenclature
1	Input	Displays selected input (A or B)
2	Status	Displays audio type as Mute, AES, or Embedded Displays audio clip or mute alarm indicators
3	Channel Number	Shown as 1-16 (AES is 1-2 and Embedded is 1-16)
4	Device	Displays labels for lissajous, bar graphs, and headphone outputs
5	Lissajous Display (2)	Lissajous of bar graph 2 with labels for R, L, and the number of the meter being monitored (for example, M-2)
6	Lissajous Display (1)	Lissajous of bar graph 1 with labels for R, L, and the number of the meter being monitored (for example, M-1)
7	Zoom	Zoom (when enabled); blank when disabled
8	Scale Selection	Displays the selected meter scale: Type I, Type IIa, Type IIb, Type I + 8, Nordic, DIN 45406, dBFS, Zero REF dBFS, Custom dB, and Custom dBFS
9	Level Markers	Shows peak and reference levels for the signal; this can be adjusted in the Audio → Meter Setup selection options
10	Meter Response	Displays selected meter response: VU, Peak, True Peak, VU + Peak, VU + True Peak, Custom
11	Audio Graticule (with meter labels)	Shown as L1, R1, L2, and R2 (or Custom label)
12	Phase Bar (1)	Phase Meter of bar graph 1
13	Phase Bar (2)	Phase Meter of bar graph 2

Figure 4-31. Six Bar Graph Display Diagram

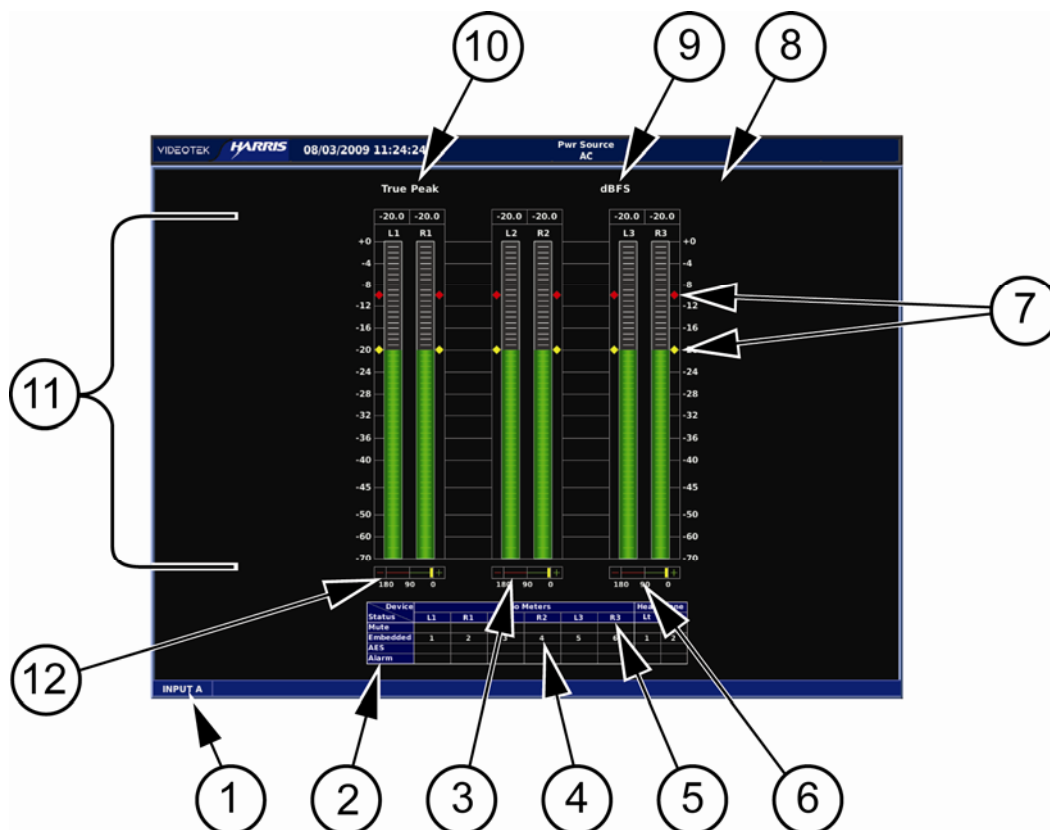

Table 4-11. Description of Six Bar Graph Display Diagram

Field Identifier	Field Information	Nomenclature
1	Input	Displays selected input (A or B)
2	Status	Displays audio type as Mute, AES, or Embedded Displays audio clip or mute alarm indicators
3	Phase Bar (2)	Phase Meter of bar graph 2
4	Channel Number	Shown as 1-16 (AES is 1-2 and Embedded is 1-16)
5	Device	Displays labels for lissajous, bar graphs, and headphone outputs
6	Phase Bar (3)	Phase Meter of bar graph 3
7	Level Markers	Shows peak and reference levels for the signal; this can be adjusted in the Audio → Meter Setup selection options
8	Zoom	Zoom (when enabled); blank when disabled
9	Scale Selection	Displays the selected meter scale: Type I, Type IIa, Type IIb, Type I + 8, Nordic, DIN 45406, dBFS, Zero REF dBFS, Custom dB, and Custom dBFS
10	Meter Response	Displays the selected meter response: VU, Peak, True Peak, VU + Peak, VU + True Peak, Custom
11	Audio Graticule (with meter labels)	Shown as L1, R1, L2, R2, L3, and R3 (or Custom label)
12	Phase Bar (1)	Phase Meter of bar graph 1

Figure 4-32. Eight Bar Graph Display Diagram

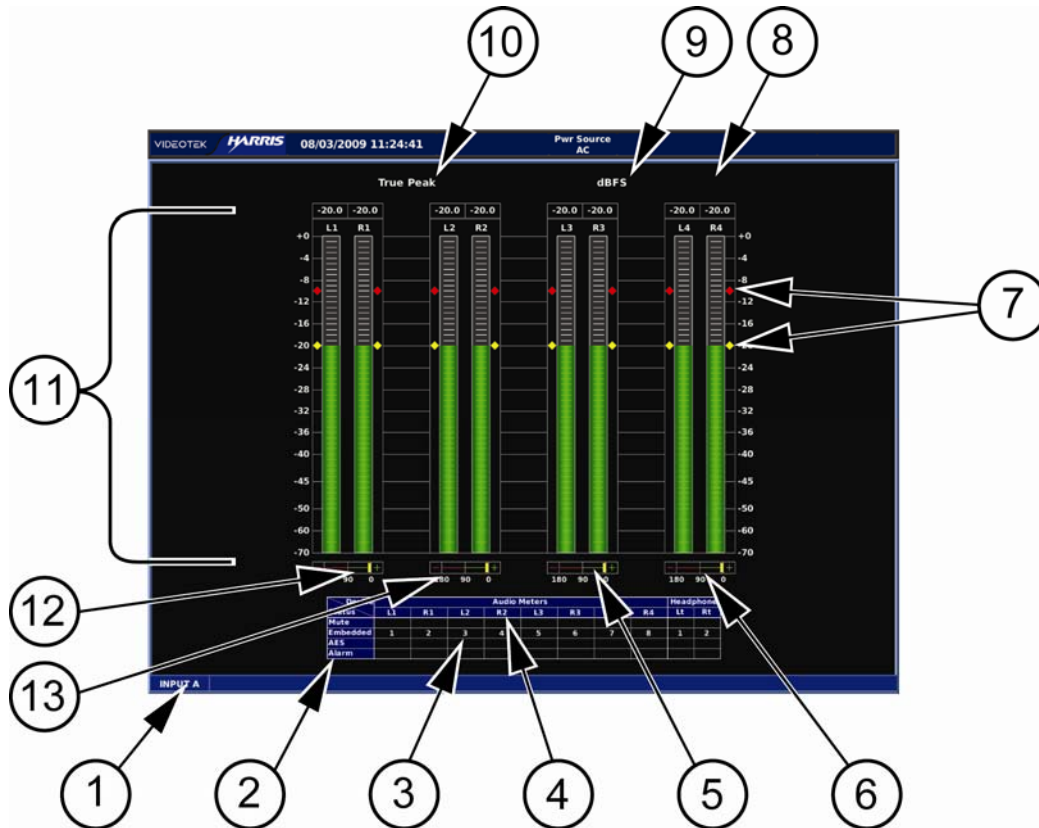

Table 4-12. Description of Eight Bar Graph Display Diagram

Field Identifier	Field Information	Nomenclature
1	Input	Displays selected input (A or B)
2	Status	Displays audio type as Mute, AES, or Embedded Displays audio clip or mute alarm indicators
3	Channel Number	Shown as 1-16 (AES is 1-2 and Embedded is 1-16)
4	Device	Displays labels for lissajous, bar graphs, and headphone outputs
5	Phase Bar (3)	Phase Meter of bar graph 3
6	Phase Bar (4)	Phase Meter of bar graph 4
7	Level Meters	Shows peak and reference levels for the signal; this can be adjusted in the Audio → Meter Setup selection options
8	Zoom	Zoom when enabled; blank when disabled
9	Scale Selection	Displays the selected meter scale: Type I, Type IIa, Type IIb, Type I + 8, Nordic, DIN 45406, dBFS, Zero REF dBFS, Custom dB, and Custom dBFS
10	Meter Response	Displays selected meter response: VU, Peak, True Peak, VU + Peak, VU + True Peak, Custom
11	Audio Graticule (with meter labels)	Shown as L1, R1, L2, R2, L3, R3, L4, and R4 (or Custom label)
12	Phase Bar (1)	Phase Meter of bar graph 1
13	Phase Bar (2)	Phase Meter of bar graph 2

Figure 4-33. Sixteen Bar Graph Display Diagram

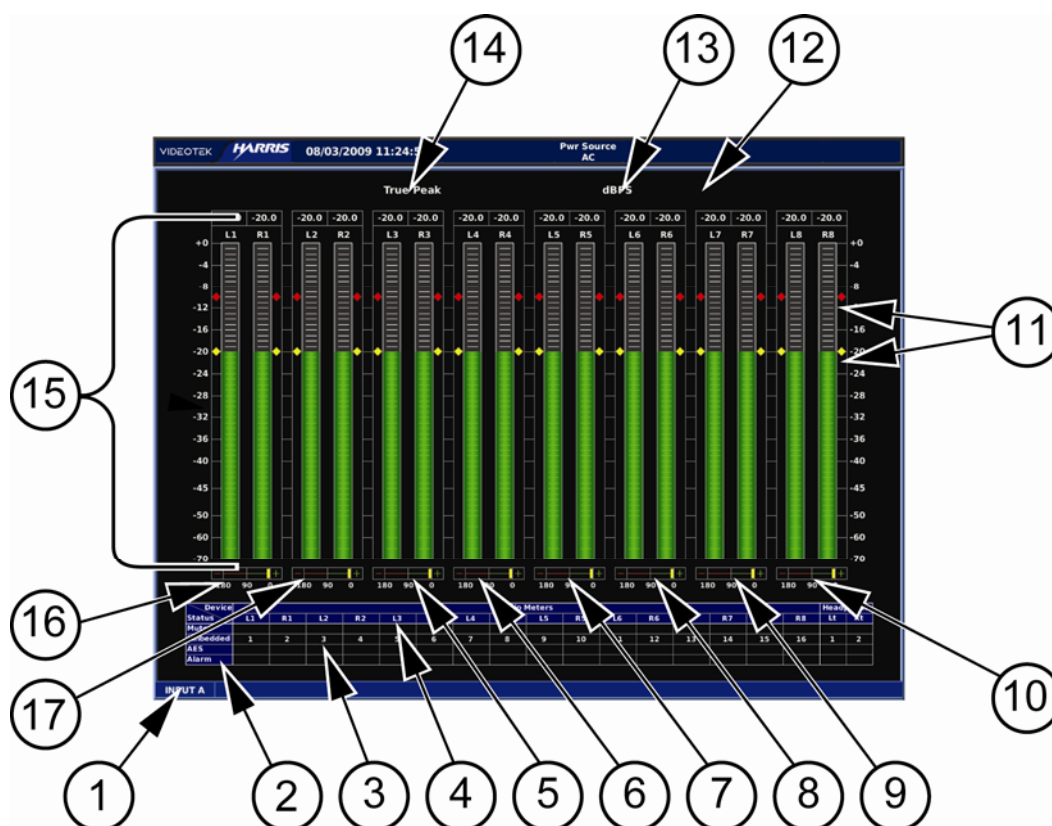

Table 4-13. Description of Sixteen Bar Graph Display Diagram

Field Identifier	Field Information	Nomenclature
1	Input	Displays selected input (A or B)
2	Status	Displays audio type as Mute, AES, or Embedded Displays audio clip or mute alarm indicators
3	Channel Number	Shown as 1-16 (AES is 1-2 and Embedded is 1-16)
4	Device	Displays labels for lissajous, bar graphs, and headphone outputs
5	Phase Bar (3)	Phase Meter of bar graph 3
6	Phase Bar (4)	Phase Meter of bar graph 4
7	Phase Bar (5)	Phase Meter of bar graph 5
8	Phase Bar (6)	Phase Meter of bar graph 6
9	Phase Bar (7)	Phase Meter of bar graph 7
10	Phase Bar (8)	Phase Meter of bar graph 8
11	Level Markers	Shows peak and reference levels for the signal; this can be adjusted in the Audio → Meter Setup selection options
12	Zoom	Zoom when enabled; blank when disabled
13	Scale Selection	Displays the selected meter scale: Type I, Type IIa, Type IIb, Type I + 8, Nordic, DIN 45406, dBFS, Zero REF dBFS, Custom dB, and Custom dBFS
14	Meter Response	Displays selected meter response: VU, Peak, True Peak, VU + Peak, VU + True Peak, Custom
15	Audio Graticule (with meter labels)	Shown as L1, R1, L2, R2, L3, R3, L4, R4, L5, R5, L6, R6, L7, R7, L8, or R8 (or Custom label)

Table 4-13. Description of Sixteen Bar Graph Display Diagram

Field Identifier	Field Information	Nomenclature
16	Phase Bar (1)	Phase Meter of bar graph 1
17	Phase Bar (2)	Phase Meter of bar graph 2

Expanding the Audio Display



Press the ZOOM button to access the audio zoom feature. The range of the zoom is dependent on the selections made in the ZOOM CENTER and ZOOM RANGE menu. Press and hold the ZOOM button to access this menu.

- **Zoom Center:** Adjustable from +20 dB to –60 dB in 1 dB steps. The default is the Reference Level setting. The zoom center adjustment is restricted by Audio Scale, Reference Level, and Zoom Range selections.
- **Zoom Range:** Adjustable from 4 dB to 20 dB in 2 dB steps. The default is 10 dB. The Zoom Range adjustment is restricted by Audio Scale, Reference Level, and Zoom Center selections.

NOTE: Zoom must be enabled to view the new adjustments.

Audio Mapping

The Audio Mapping matrix is used to assign any audio input to a meter and/or headphone output. See page 74 for more information.

Audio Setup

Press and hold the AUD button to access the global Audio Setup menu. For more information on the global Audio Setup menu, see page 68. For descriptions of Audio Setup menu selection options, see page 80.

Alarm Display



Press and release the ALRM function button for the alarm display. Press and hold the ALRM function button to access the Alarm Setup menu. The default alarm display is the Alarm Log. For information on individual alarms, see “Setting Alarms” on page 89.

Alarm Log Display

The Alarm Log display lists all the alarms, the date, time, time code, duration, and peak value. The alarm list begins with the most recent alarm and can hold a maximum of 100 alarms.

NOTE: The Alarm Log display is the default alarm display. The Alarm Status display is accessed via the Alarm Setup menu.

An Alarm Log display diagram is shown in **Figure 4-34** and described in **Table 4-14**. The diagram illustrates the general location for the various alarm fields.

Figure 4-34. Alarm Log Display Diagram

Alarm Name	Date	Time	Timecode	Length	Value
1 RGB Gamut Upper B	06/15/09	10:31:43	00:00:00:00	00:00:24	+680 mV
2 Luma Gamut Lower	06/15/09	10:31:36	00:00:00:00	00:00:31	+0 IRE
3 Peak Gamut Lower	06/15/09	10:31:33	00:00:00:00	00:00:34	-92 IRE
4 RGB Gamut Lower B	06/15/09	10:31:33	00:00:00:00	00:00:34	-794 mV
5 RGB Gamut Lower G	06/15/09	10:31:33	00:00:00:00	00:00:34	-473 mV
6 RGB Gamut Lower R	06/15/09	10:31:33	00:00:00:00	00:00:34	-681 mV
7 Loss Active Video	06/15/09	10:30:34	00:00:00:00	00:01:33	NO RPV
8 Luma Gamut Lower	06/15/09	10:31:33	00:00:00:00	00:00:03	+0 IRE
9 Luma Gamut Lower	06/15/09	10:31:26	00:00:00:00	00:00:07	+0 IRE
10 RGB Gamut Lower B	06/15/09	10:31:26	00:00:00:00	00:00:07	-794 mV
11 RGB Gamut Lower G	06/15/09	10:31:26	00:00:00:00	00:00:07	-473 mV
12 RGB Gamut Lower R	06/15/09	10:31:26	00:00:00:00	00:00:07	-681 mV
13 Peak Gamut Lower	06/15/09	10:31:25	00:00:00:00	00:00:08	-92 IRE
14 Peak Gamut Lower	06/15/09	10:31:00	00:00:00:00	00:00:25	-92 IRE
15 Luma Gamut Lower	06/15/09	10:31:00	00:00:00:00	00:00:25	+0 IRE
16 RGB Gamut Lower B	06/15/09	10:31:00	00:00:00:00	00:00:25	-794 mV
17 RGB Gamut Lower G	06/15/09	10:31:00	00:00:00:00	00:00:25	-473 mV
18 RGB Gamut Lower R	06/15/09	10:31:00	00:00:00:00	00:00:25	-681 mV
19 Peak Gamut Lower	06/15/09	10:30:58	00:00:00:00	00:00:02	-92 IRE
20 Luma Gamut Lower	06/15/09	10:30:58	00:00:00:00	00:00:02	+0 IRE
21 RGB Gamut Lower B	06/15/09	10:30:58	00:00:00:00	00:00:02	-794 mV
22 RGB Gamut Lower G	06/15/09	10:30:58	00:00:00:00	00:00:02	-473 mV
23 RGB Gamut Lower R	06/15/09	10:30:58	00:00:00:00	00:00:02	-681 mV

Table 4-14. Description of Alarm Log Display Diagram

Field Identifier	Field Information	Nomenclature
1	Input	Displays selected input (A or B)
2	Column Labels	Displays the labels # (for the number in the alarm list), ALARM NAME, DATE, TIME, TIMECODE, LENGTH (Duration), and PEAK VALUE*
3	Alarm List	Displays the list of alarms from the most recent alarm to the last recorded alarm (a maximum of 100 alarms can be logged)

*NOTE: Certain alarm parameters do not have a level measurement that can report a peak value. This is indicated when NO RPV (No Report Peak Value) appears in the PEAK VALUE column.

When an alarm is first registered, it appears on the alarm display and is highlighted in yellow. If the alarm is short term (that is, two seconds or less), the alarm text is not highlighted after approximately two seconds. If the alarm continues longer than two seconds, the text remains yellow and the alarm duration is incremented. When the next alarm occurs, the previous alarm moves down one position.

The CMN-41 unit has enough memory for 100 alarms per input. When 100 different alarm events have occurred, alarm number 100 is dropped and the most recent alarm is tagged as 01.

Use the Up/Down navigation buttons to scroll through the alarm list

To erase the current group of alarms, press the CLEAR button.

A GPI output dry-contact closure can be used to alert other devices when an alarm occurs. Use the Unit Configuration → GPIO selection option (page 71) to set up the GPI.

Alarm Status Display

The Alarm Status screen lists all the alarms, the state of each alarm setting, the current alarm limit selection (if applicable), the current alarm duration (if applicable), and the Accumulated alarm column.

The Alarm Status display is accessed via the Alarm Setup menu. Press and hold the ALRM function button to access the Alarm Setup menu. Use the Up/Down navigation buttons to scroll to the Alarm Status selection option. Press the ENT navigation button to select the Alarm Status display.

An alarm status display diagram is shown in **Figure 4-35**. The diagram illustrates the general location for the various alarm status display fields.

Figure 4-35. Alarm Status Display Diagram



The screenshot shows the Alarm Status Display screen with a table of alarm settings. The table has columns for Alarm Name, Enable, Lower Limit, Upper Limit, Threshold, Duration, and Total Alarms. The status of each alarm is indicated by the color of the text: White (not enabled), Green (enabled and not exceeding limits), and Red (enabled and exceeding limits).

Alarm Name	Enable	Lower Limit	Upper Limit	Threshold	Duration	Total Alarms
Format Change	On					2
Payload Ident Mismatch	On					0
Loss Of Carrier	On				2 Seconds	0
Loss Of Reference	Off				2 Seconds	0
Loss Active Video	On	300 mV		2 CES	2 Seconds	2
Loss Of Payload Ident	Off				2 Seconds	0
RGB Gamut Upper R	On		684 mV	1 CES	2 Seconds	1
RGB Gamut Upper G	On		684 mV	1 CES	2 Seconds	1
RGB Gamut Upper B	On		684 mV	1 CES	2 Seconds	1
RGB Gamut Lower R	On	5 mV		1 CES	2 Seconds	33
RGB Gamut Lower G	On	5 mV		1 CES	2 Seconds	39
RGB Gamut Lower B	On	5 mV		1 CES	2 Seconds	33
Luma Gamut Upper	On		90 IRE/Units	15 CES	2 Seconds	1
Luma Gamut Lower	On	47 IRE/Units		15 CES	2 Seconds	45
Peak Gamut Upper	On		120 IRE/Units	15 CES	2 Seconds	0
Peak Gamut Lower	On	-5 IRE/Units		15 CES	2 Seconds	37
CRC - HD	Off				2 Seconds	0
EDH - SD	Off				2 Seconds	0
Letter Box Top - SD	Off		Line 0	286 mV	2 Seconds	0
Letter Box Bottom - SD	Off		Line 140	286 mV	2 Seconds	0
Pillar Box Left - HD	Off		Pixel 1	286 mV	2 Seconds	0
Pillar Box Right - HD	Off		Pixel 1920	286 mV	2 Seconds	0
Picture Shift	Off	2 mV	2 Lines	2 Pixels		0

The alarm status screen contains detailed information concerning alarm status indicators. This information is separated into columns sorted by alarm name, whether or not the alarm is enabled, lower and upper limits, thresholds, duration, and total number of alarms. The alarm name text can appear in a colored state. The colored states are:

- **White:** indicates alarm is not enabled.
- **Green:** indicates alarm is enabled and not exceeding alarm limits.
- **Red:** indicates the alarm is enabled and exceeding an alarm limits.

There is a two-second persistence for any alarm name color change.

Use the Up/Down navigation buttons to scroll through the Alarm Status list.

Video Alarms

Press and hold the ALRM button to access the Alarms Setup menu. If necessary, use the Up/Down navigation arrows to select the Video Alarms selection option. Press the ENT navigation button to show the available selection options.

For more information on the global Video Alarms Setup menu, see page 89. For descriptions of Video Alarms selection options, see page 94.

Audio Alarms

Press and hold the ALRM button to access the Alarms Setup menu. If necessary, use the Up/Down navigation arrows to select the Audio Alarms selection option. Press the ENT navigation button to show the available selection options.

For more information on the global Audio Alarms Setup menu, see page 92. For descriptions of Audio Alarms selection options, see page 94.

Time Code Alarms

Press and hold the ALRM button to access the Alarms Setup menu. If necessary, use the Up/Down navigation arrows to select the Time Code Alarms selection option. Press the ENT navigation button to show the available selection options.

For more information on the global Time Code Alarms Setup menu, see page 93. For descriptions of Time Code Alarms selection options, see page 96.

GPI Alarms

Up to four general purpose interface alarms can be enabled. Press and hold the ALRM button to access the Alarms Setup menu. If necessary, use the Up/Down navigation arrows to select the GPI Alarms selection option. Press the ENT navigation button to show the available selection options.

Timing Display



Press and release the TIME function button to access the Timing display. A Timing display diagram is shown in **Figure 4-36** and described in **Table 4-15**. The diagram illustrates the general location for the various Timing display fields.

Press and hold the TIME button to access the Timing Setup menu. (Press the SETUP or the EXIT button to clear the Timing Setup menu.)

Relative timing of the inputs is compliant with SMPTE RP168.

Figure 4-36. Timing Display Diagram

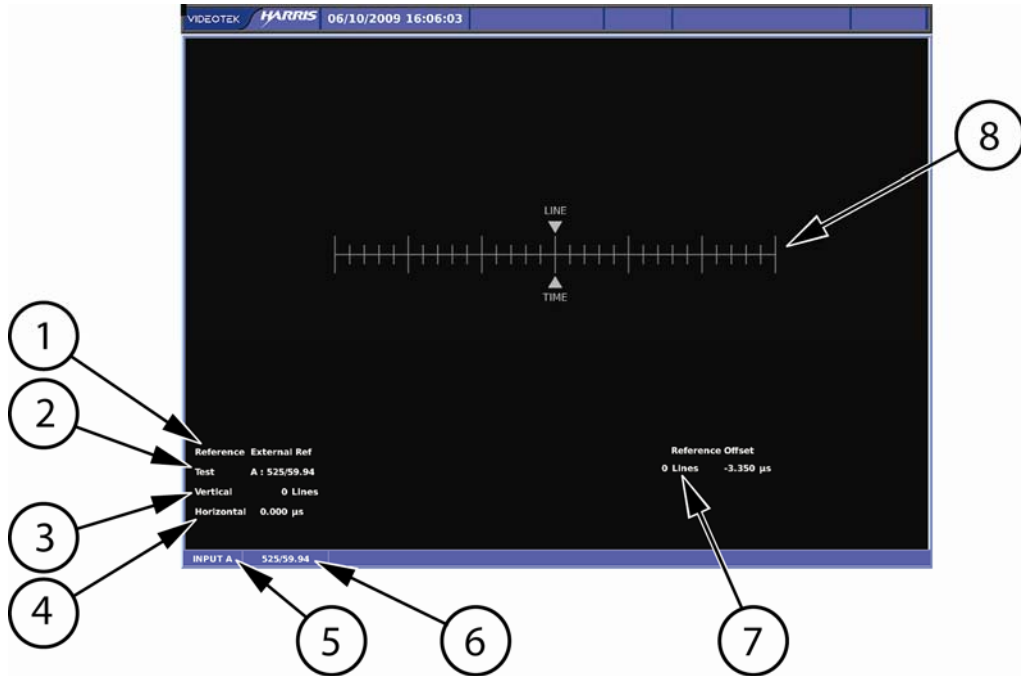

Table 4-15. Description of Timing Display Diagram

Field Identifier	Field Information	Nomenclature
1	Selected reference	Displays the selected reference as REF: X where X is ExtREF or LTC; the REF is selected in the Timing Setup menu; also indicates reference format
2	Test	Indicates the input that is being measured against the selected reference in Field Identifier 1; also displays the input's line rate/frame rate (shown in Figure 4-36 as 525/59.94); selected in the Video Setup menu
3	VERT (Vertical)	The offset line in full-video lines between the reference and the displayed video Displays the Vertical Error Measurement as VERT: xxx Line(s), where xxx is the measured difference between the reference and the test input alignment of the vertical timing (sync/TRS) in lines
4	HORZ (Horizontal)	The offset time in microseconds between the reference and the displayed video. Displays the Horizontal Error Measurement as HORZ: yy.yyy μs, where yy.yyy is the measured difference between the reference and the test input alignment of the horizontal timing (sync/TRS) Horizontal can be yellow at 0 μs. It displays the minimum scale resolution at 1μ and the minimum timing resolution at 0.037 μs for HD (High Definition) and 0.74 μs for SD (Standard Definition).
5	Input	Displays selected input (A or B)
6	Standard	Displays the line rate/frame rate; select the Standard in the Video Setup menu
7	REF OFFSET	Displays that the zero point of the timing measurements are offset from the REF selection by xx lines yy.yyy μs
8	Timing Graticule	Shows the timing graticules, cursors, and labels

When a signal is processed, there is the potential for it to be delayed with respect to a reference signal. The timing display is used to indicate when a video input is deviating in time from the reference. See “Reference” on page 82 for more information on reference selection.

The reference input indicator (REF), located in the center of the timing display, indicates the reference-timing point for the type of signal being monitored. REF is green when the line and μ s (microseconds) cursors are all aligned. As the signal falls out of timing alignment, the line and the μ s cursors change color when it moves from REF. When this occurs, the REF turns red. Each hash mark represents a vertical line (top scale) and 1μ s (bottom scale). Once the line or μ s cursors are at the edge of the display, arrows will appear to the right or left of the timing line.

NOTE: The Timing Display alignment accuracy is ± 280 ns.

SDI Input and External Reference Formats Supported

Table 4-16. SDI Input and External Reference Formats Supported

• = Supported

SDI Input Format	External Reference Format																			
	NTSC	PAL	1080i60 (p30sf)	1080i59.94 (p29.97sf)	1080i50 (p25sf)	1080p30	1080p29.97	1080p25	1080p24	1080p23.98	1080p24sf	1080p23.98sf	720p60	720p59.94	720p50	720p30	720p29.97	720p24	720p23.98	
525/59.94	•			•			•													
625/50		•			•			•												
1080i60(p30sf)			•			•														
1080i59.94(p29.97sf)	•			•			•													
1080i50(p25sf)		•			•			•												
1080p60																				
1080p59.94	•			•										•						
1080p50		•			•			•												
1080p30			•			•										•				
1080p29.97	•			•			•										•			
1080p25		•			•			•												
1080p24									•		•							•		
1080p23.98										•		•								•
1080p24sf									•		•									
1080p23.98sf										•		•								
720p60			•			•							•			•				
720p59.94	•			•			•							•			•			
720p50		•			•			•							•					
720p30			•			•							•			•				
720p29.97	•			•			•							•			•			
720p24									•		•							•		
720p23.98										•		•								•

Things to Remember When Using the Timing Display

1. The Timing Display measures the elapsed time between the vertical syncs of two inputs. The elapsed time is expressed in units of microseconds and lines of the selected input video, not of the reference.
2. When referencing a standard definition video input to an external tri-level reference input, the line number indication in the timing display represents standard definition video lines. If the relative timing is adjusted in high definition video lines, it may take an adjustment of two or more lines before the line number changes in the timing display. This is due to the high definition video lines, which are shorter than the standard definition video lines represented by the timing display.
3. When referencing a high definition video input to an external composite (BB) reference input, the line number indication in the timing display represents high definition video lines. If the relative timing is adjusted in standard definition video lines, a single video line adjustment will cause a change of two or more lines in the timing display. This is due to the standard definition video lines, which are longer than the high definition video lines represented by the timing display.
4. The information of the Timing Display should not be used when captured SDI freeze data is displayed.

Timing Setup Menu

Press and hold the TIME function button to access the Timing Setup menu. For more information on the global Timing Setup menu, see page 70. For descriptions of Timing selection options, see page 81.

Option Display Selections

NOTE: Only one option display can be shown at a time.

The option display shows a waveform display of the LTC or external reference inputs.



Press and release the OPT button to select the external reference or LTC waveform display. Press and hold the OPT function button to access the Option Setup menu. (Press the SETUP or the EXIT button to clear the Timing Setup menu.)

Moving the Waveform

Move the Waveform display relative to the graticule by selecting the POS button, and then using the Left and Right arrow knobs (for horizontal movement) and the Up and Down knob (for vertical movement).

Scroll the Left/Right (horizontal direction) or Up/Down (vertical direction) arrow knob to move the waveform in the particular direction. Press the Left/Right or Up/Down arrow knobs to center the waveform horizontally or vertically.

Figure 4-37. LTC Display Diagram

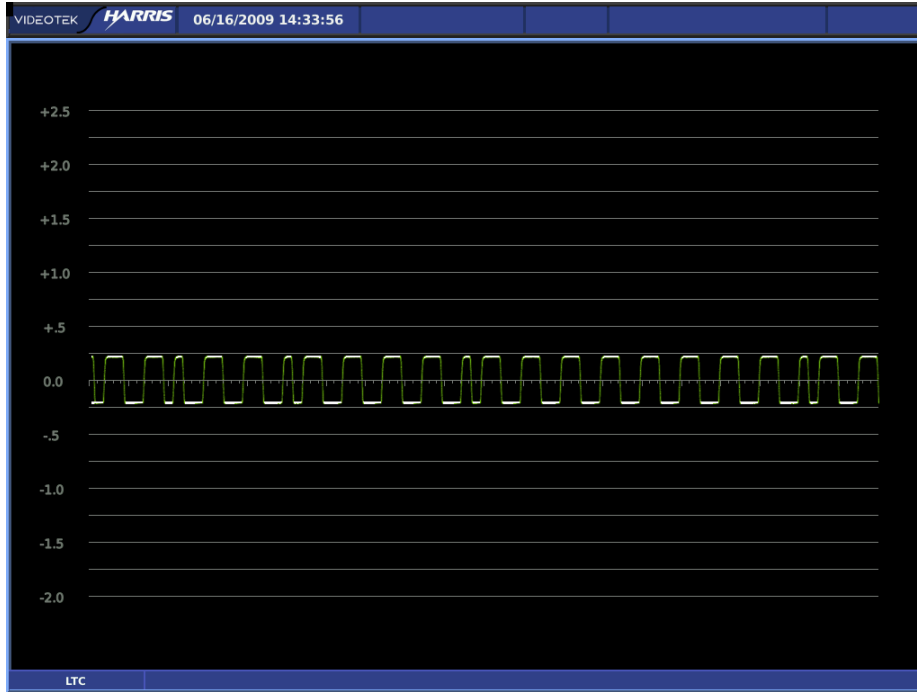
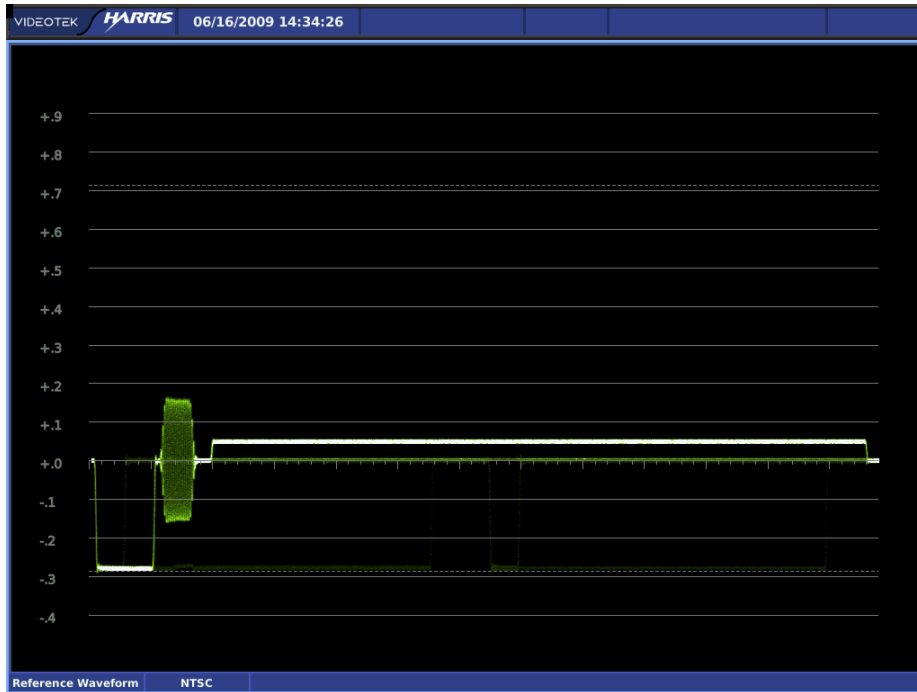
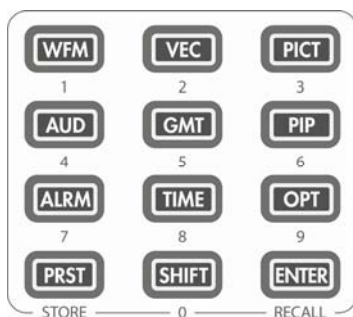

Figure 4-38. External Reference Display Diagram



Preset Display Selections



Presets are used to store menu configurations and display settings. A total of 99 presets can be stored in the CMN-41.

Selecting Presets



Press and release the PRST function button to access the bank of presets. A dialog box appears on the display screen, which shows the Preset number. Press selection button 1 to 99 (or scroll through the available list using the curved arrow knob) to select a preset. Press PRST to store or overwrite an existing Preset, or press ENTER to Recall.

Storing Presets

Press the PRST button to bring up the Presets dialog box. Press selection button 1 to 99 (or scroll through the available list using the curved arrow knob) to store the Preset. Press the PRST button to store a new or overwrite an existing Preset.

Recalling Presets

NOTE: Information must be stored in a preset location before being recalled.

Press the PRST function button to bring up the Presets dialog box. Press selection button 1 to 99 (or scroll through the available list using the curved arrow knob) to recall the Preset. Press the ENTER button to recall the Preset.









If a preset does not exist for the selected number, nothing happens.

Section 5 ♦ Global Setup Menu Functions

Navigating the Setup Menu

Press the SETUP button to access the global setup menu. Use the Setup position knobs or the navigation buttons to navigate the global Setup menu selection options. The Setup position knobs and navigation buttons are described below:

Table 5-1. Setup Position Knobs and Navigation Buttons

Item	Function
	Press to enter or exit the Setup menu.
	Press to exit from the Setup menu.
	Press to move up in the Setup menu or matrix screen.
	Press to move left in the Setup menu or matrix screen.
	Press to move right in the Setup menu or matrix screen.
	Press to move down in the Setup menu or matrix screen.
	Rotate to set numeric values for certain parameters. Press to set parameter to default value.
	Press to select a menu selection option.
	Press to use the numeric keypad for direct parameter entry. The SHIFT button will be high tally to indicate that the numeric keypad is available for direct parameter entry.

Setup Menus and Alarm Tables

The following tables make up the global setup menu. An asterisk (*) is shown next to the default menu selections. The Setup menu items are listed in **Table 5-2** with their corresponding Table and Description pages.

Table 5-2. Setup Menu Tables

Selection	Table Page	Description Page
Video	65	73
Audio mapping	65	74
Time code source	66	75
Waveform	66	75
Vector	67	77
Gamut	67	78
Picture	67	77
Audio	68	80
Timing	70	81
OPT	70	82
MLT	71	82
Alarms	Alarm setup tables and corresponding descriptions appear in Section 6.	
Enable Dual A-B Link	—	—
Import/Export	71	82
Clear	71	83
Unit Configuration	71	83

Table 5-3. Video Setup Menu**NOTE:** Descriptions for these selection options start on page 73.

Selection Option	Selection Option
Auto Detect *	
1080i	
1080i Frame Rate	60
	59.94 *
	50
1080p	
1080p Frame Rate	60
	59.94 *
	50
	30
	29.97
	25
	24
	23.98
1080psF	
1080psF Frame Rate	30sF
	29.97sF *
	25sF
	24sF
	23.98sF
720p	
720p Frame Rate	60
	59.94 *
	50
	30
	29.97
	24
	23.98
625/50	
525/59.94	
Structure	Auto Detect *
	10 bit YCbCr 4:2:2
	10 bit YCbCr 4:4:4
	10 bit RGB 4:4:4
	12 bit YCbCr 4:4:4
	12 bit RGB 4:4:4
	12 bit YCbCr 4:2:2

Table 5-4. Audio Mapping Menu**NOTE:** Descriptions for these selection options start on page 74.

Selection Option
Matrix Screen

Table 5-5. Time Code Source Setup Menu**NOTE:** Descriptions for these selection options start on page 75.

Selection Option	Selection Option
LTC *	
ANC LTC	
ANC DIVTC 0	
ANC DVITC 1	
DVITC	
DVITC Line 525	Line 10 to 30 (line 14 *)
DVITC Line 625	Line 6 to 30 (line 14 *)

Table 5-6. Waveform Setup Menu**NOTE:** Descriptions for these selection options start on page 75.

Selection Option	Selection Option	Selection Option
Display/Format	YCbCr *	
	RGB	
	Composite	
	YCbCr + alpha	
	RGB + alpha	
Component Filter	Flat *	
	Low pass	
	Bowtie	
Composite Filter	Flat *	
	Low pass	
	Chroma	
	Flat and low pass	
Component Overlay		
Blanking	Blank All *	
	Show SAV/EAV	
	Show All	
Error Highlighting		
Graticule	Digital Waveform Graticule	Volts *
		Percent
	NTSC Pedestal *	
PAL Waveform Scale	Volts *	
	Units	
Intensity	0% to 100% (72% *)	
Contrast	0% to 100% (31% *)	
Persistence	0% to Infinite (0% *)	
Attack	1% to Maximum (6% *)	

Table 5-7. Vector Setup Menu

NOTE: Descriptions for these selection options start on page 77.

Selection Option	Selection Option
Standard	75%
	100% *
	75% + 100%
I/Q Lines	
Scale to Composite	
Intensity	0% to 100% (86% *)
Contrast	0% to 100% (55% *)
Persistence	0% to Infinite (0% *)
Attack	1% to Maximum (10% *)

Table 5-8. Gamut Setup Menu

NOTE: Descriptions for these selection options start on page 78.

Selection Option	Selection Option
Single color	
RGB *	
Composite	
Data Error Persistence	0% to Infinite (0% *)
Intensity	0% to 100% (86% *)
Contrast	0% to 100% (55% *)
Persistence	0% to Infinite (0%)*

Table 5-9. Picture Setup Menu

NOTE: Descriptions for these selection options start on page 78.

Selection Option	Selection Option	Selection Option
Markers	Center	
	Safe Title (Corners)	
	Safe Title (Box)	
	Safe Action (Corners)	
	Safe Action (Box)	
	Clean Aperture (Corners)	
	Clean Aperture (Box)	
	Custom (Corners)	
	Custom (Box)	
	Custom Position	1% to 49% (20% *)
	Custom Length	3% to 47 (5% *)
Anamorphic		
Time Code	Enable	
	Show LTC	
	Position	Top *
		Center
		Bottom
Brightness	0% to 100% (50% *)	
Contrast	0% to 100% *	

Table 5-9. Picture Setup Menu**NOTE:** Descriptions for these selection options start on page 78.

Selection Option	Selection Option	Selection Option
Color	Green *	
	Blue *	
	Red *	
VBI Mask		
Native		
Delay	Enable	
	H Position	1 pixel to ___ pixels (format-dependent)
	V Position	1 line to ___ lines (format-dependent)
Gamut Error Highlighting		

Table 5-10. Audio Setup Menu**NOTE:** Descriptions for these selection options start on page 80.

Selection Option	Selection Option	Selection Option	Selection Option
2 Channels			
4 Channels			
6 Channels	Vertical *		
	CineSound		
8 Channels *	Vertical		
	CineSound 5.1 + AUX *		
	CineSound 6.1		
	CineSound 7.1		
16 Channels			
Meter Setup	Reference Level	-22 dBFS to -8 dBFS (-20 dBFS *)	
	Peak Program Level	Type I	+1 dB to +11 dB (+8 dB *)
		Type IIa	+1 dB to +11 dB (+8 dB *)
		Type IIb	+1 dB to +11 dB (+8 dB *)
		Type I + 8	+1 dB to +19 dB (+8 dB *)
		Nordic	+1 dB to +11 dB (+6 dB *)
		DIN 45406	+1 dB to +13 dB (+8 dB *)
		dBFS	+1 dB to +21 dB (+10 dB *)
		Zero Ref dBFS	+1 dB to +21 dB (+8 dB *)
		Custom dBFS	+1 dB to +21 dB (+10 dB *)
Custom dB	+1 dB to +21 dB (+9 dB *)		

Table 5-10. Audio Setup Menu**NOTE:** Descriptions for these selection options start on page 80.

Selection Option	Selection Option	Selection Option	Selection Option
	Scale	Type I	
		Type IIa	
		Type IIb	
		Type I + 8	
		Nordic	
		DIN 45406	
		dBFS *	
		Zero Ref dBFS	
		Custom dBFS	
		Custom dB	
		Custom dBFS Top	0 dBFS to -20 dBFS (0 dBFS *)
		Custom dBFS Bottom	-40 dBFS to -90 dBFS (-40 dBFS *)
		Custom dB Top	0 dB to 20 dB (10 dB *)
	Custom dB Bottom	-20 dB to -70 dB (-30 dB *)	
	Zoom	Center at Reference Level *	
		Center at dB Level	-60 dB to +20 dB (0 dB*)
		Zoom Range	4 dB to 20 dB (10 dB)
	Peak Hold Time	Off *	
		1 to 10 seconds	
		Infinite	
	Meter Labels	Stereo Pairs *	
		SMPTE 320M	
		Custom	
		Custom Labels 1-8	Channel (1-8) → Use arrow keys to edit and change characters
		Custom Labels 9-16	Channel (9-16) → Use arrow keys to edit and change characters
	LFE Offset	-10 dB	
		None *	
	CineSound Direction	Outward *	
		Inward	
	Audio Markers	Enable	
		Position	-50 to +12 dB (0 dB *)

Table 5-10. Audio Setup Menu**NOTE:** Descriptions for these selection options start on page 80.

Selection Option	Selection Option	Selection Option	Selection Option
Meter Response	VU *		
	Peak		
	True Peak		
	VU + Peak		
	VU + True		
	Peak		
	Custom		
	Custom Attack	0 to 20 ms (0 ms *)	
	Custom Decay	0.3 to 5.0 seconds (1.5 seconds *)	
Lissajous Setup	Persistence	0% to Infinite (0% *)	
	Attack	1% to Maximum (50% *)	
	Automatic Gain Control		
	Plot	Soundstage *	
X-Y			
Configure Phase Bar(s)	Polarity	Normal *	
		Reverse	
	Damping	Slow	
		1 to 10 (5 *)	
	Fast		
AES Validity Bit			

Table 5-11. Timing Setup Menu**NOTE:** Descriptions for these selection options start on page 81.

Selection Option	Selection Option
Reference	External Ref *
	LTC
Factory *	
Offset	
Set Zero Ref	

Table 5-12. OPT Setup Menu**NOTE:** Descriptions for these selection options start on page 82.

Selection Option
LTC *
Reference Waveform

Table 5-13. MLT Setup Menu

NOTE: Descriptions for these selection options start on page 82.

Selection Option	Selection Option
Intensity	0% to 100% (72% *)
Contrast	0% to 100% (31% *)
Persistence	0% to Infinite (0% *)
Attack	1% to Maximum (6% *)

Table 5-14. Import/Export Setup Menu

NOTE: Descriptions for these selection options start on page 82.

Selection Option
File Navigator Screen

Table 5-15. Clear Setup Menu

NOTE: Descriptions for these selection options start on page 83.

Selection Option
DISP Captures
SDI Captures
Audio Peak Hold
Alarm Log
Alarm Error Count
Timing Zero Reference
Persistence

Table 5-16. Unit Configuration Setup Menu

NOTE: Descriptions for these selection options start on page 83.

Selection Option	Selection Option	Selection Option	Selection Option
Display Setup	Input Color	Blue	
		Green	
		Cyan	
		Red	
		Magenta	
		Brown	
		Gray	
		Dark Gray	
		Light Blue	
		Light Green *	
		Light Cyan	
		Light Red	
		Light Magenta	
		Yellow	
White			

Table 5-16. Unit Configuration Setup Menu**NOTE:** Descriptions for these selection options start on page 83.

Selection Option	Selection Option	Selection Option	Selection Option
	Graticule Color	Blue	
		Green	
		Cyan	
		Red	
		Magenta	
		Brown	
		Gray	
		Dark Gray	
		Light Blue	
		Light Green	
		Light Cyan	
		Light Red	
		Light Magenta	
		Yellow	
		White *	
	Cursor Color	Blue	
		Green	
		Cyan	
		Red	
		Magenta	
		Brown	
		Gray	
		Dark Gray	
		Light Blue	
		Light Green	
		Light Cyan	
		Light Red *	
		Light Magenta	
		Yellow	
		White	
	Aspect Ratio	4:3 *	
		16:9	
		16:10	
Sleep Mode	Off to 60 Minutes		
Monochrome Display			
Graticule Intensity	0 to 100% (50% *)		
Cursor Intensity	0 to 100% *		
Front Panel	High Tally	35 to 100% (80% *)	
	Low Tally	0 to 10% (5% *)	

Table 5-16. Unit Configuration Setup Menu**NOTE:** Descriptions for these selection options start on page 83.

Selection Option	Selection Option	Selection Option	Selection Option
GPIO	Input Function	Input 1	Select A
			Select B
			User GPI Alarm 1 *
		Input 2	Select A
			Select B
			User GPI Alarm 2 *
		Input 3	Recall Preset 1
			Recall Preset 2
			User GPI Alarm 3 *
		Input 4	Recall Preset 3
			Recall Preset 4
			User GPI Alarm 4 *
	Output Function	Polarity	Normally Open *
Normally Closed			
Setup		Follow Input A	
		Follow Alarms *	
IP Configuration	Ethernet Config Screen		
System Time	Time Setup Screen		
Show Clock *			
Flash Update From USB	File Navigator Screen		
Feature Upgrade From USB	File Navigator Screen		
About	About Screen		

Video Setup Menu Selection Options

The Video Setup selection options are used to automatically or manually select the video format reference standard for the SDI input. The format selection determines the unit of measure and the critical amplitude limits for the input. The Video Setup selection options are described below.

- **Auto Detect:** This selection option is used to automatically detect the format of the input signal. This is the default setting.
- **1080i:** This selection option is used force the unit into 1080 interlaced video mode.
- **1080i Frame Rate:** This selection option is used to set up the 1080i frame rate. Selection options are 60, 59.94, and 50. The default setting is 59.94.
- **1080p:** This selection option is used to force the unit into 1080 progressive video mode.
- **1080p Frame Rate:** This selection option is used to set up the 1080p frame rate. Selection options are 60, 59.94, 50, 30, 29.97, 25, 24, and 23.98. The default setting is 59.94.

- **1080psF**: This selection option is used to force the unit into 1080 progressive segmented frame video mode.
- **1080psF Frame Rate**: This selection option is used to set up the 1080psF frame rate. Selection options are 30sF, 29.97sF, 25sF, 24sF, and 23.98sF. The default setting is 29.97sF.
- **720p**: This selection option is used to force the unit into 720 progressive video mode.
- **720p Frame Rate**: This selection option is used to set up the 720p frame rate. Selection options are 60, 59.94, 50, 30, 29.97, 24, and 23.98. The default setting is 59.94.
- **625/50**: This selection option is used force the unit into video frames with 625-line/50 Hz video mode.
- **525/59.94**: This selection option is used force the unit into frames with 525-line/(60*1000/1001) Hz video mode.
- **Structure**: This selection option is used to configure the signal handling path to a 10-bit or 12-bit RGB or YCBCR sampling structure. 12-bit modes are not available with formats 1080p/60, 1080p/59.94, and 1080p/50. 4:4:4 and 4:2:2 are the format rates selected with the 10-bit and 12-bit sampling structures. 4:2:2 is only available with 12-bit YCBCR. The selection options are as follows.
 - **Auto Detect**: The sampling structure is determined from the Video Payload Identifier. If there is no detected VPI, a 10-bit YCBCR sampling structure will be assumed. This is the default setting.
 - **10 bit YCBCR 4:2:2**: The signal handling path will be configured for a 10-bit YCBCR mode of operation.
 - **10-bit YCBCR 4:4:4**: The signal handling path will be configured for a 10-bit YCBCR mode of operation. This selection is only available for dual link and 3 Gb/s HD.
 - **10-bit RGB 4:4:4**: The signal handling path will be configured for a 10-bit RGB mode of operation. This selection is only available for dual link and 3 Gb/s HD.
 - **12-bit YCBCR 4:4:4**: The signal handling path will be configured for a 12-bit YCBCR mode of operation. This selection is only available for 3Gb/s HD.
 - **12-bit RGB 4:4:4**: The signal handling path will be configured for a 12-bit RGB mode of operation. This selection is only available for dual link and 3 Gb/s HD.
 - **12-bit YCBCR 4:2:2**: The signal handling path will be configured for a 12-bit YCBCR mode of operation. This selection is only available for dual link and 3 Gb/s HD.

Audio Mapping Setup Menu Selection Options

The Audio Mapping matrix is used to assign the input to the meter display or headphone output. When the Audio Mapping setup option is selected, a matrix screen for Mute, Embedded, and AES appears (see **Figure 5-1**). Use the Right/Left arrow knobs to scroll through the column selections. Use the Up/Down arrow knobs to scroll

through individual cell selections. Press the ENT button to assign an input to a meter. Different audio types (AES or Embedded) can be assigned to a meter or headphone output.

Figure 5-1. Audio Mapping Matrix Display

		Audio Meter Channel																Head phone	
		1	2	3	4	5	6	7	8	9	10	11	12	13	14	15	16	Lt	Rt
E M B E D D E D	Mute	0	0	0	0	0	0	0	0	0	0	0	0	0	0	0	0	0	0
		1	1	1	1	1	1	1	1	1	1	1	1	1	1	1	1	1	1
		2	2	2	2	2	2	2	2	2	2	2	2	2	2	2	2	2	2
		3	3	3	3	3	3	3	3	3	3	3	3	3	3	3	3	3	3
		4	4	4	4	4	4	4	4	4	4	4	4	4	4	4	4	4	4
		5	5	5	5	5	5	5	5	5	5	5	5	5	5	5	5	5	5
		6	6	6	6	6	6	6	6	6	6	6	6	6	6	6	6	6	6
		7	7	7	7	7	7	7	7	7	7	7	7	7	7	7	7	7	7
		8	8	8	8	8	8	8	8	8	8	8	8	8	8	8	8	8	8
		9	9	9	9	9	9	9	9	9	9	9	9	9	9	9	9	9	9
		10	10	10	10	10	10	10	10	10	10	10	10	10	10	10	10	10	10
		11	11	11	11	11	11	11	11	11	11	11	11	11	11	11	11	11	11
		12	12	12	12	12	12	12	12	12	12	12	12	12	12	12	12	12	12
		13	13	13	13	13	13	13	13	13	13	13	13	13	13	13	13	13	13
		14	14	14	14	14	14	14	14	14	14	14	14	14	14	14	14	14	14
		15	15	15	15	15	15	15	15	15	15	15	15	15	15	15	15	15	15
		16	16	16	16	16	16	16	16	16	16	16	16	16	16	16	16	16	16
A E S		1	1	1	1	1	1	1	1	1	1	1	1	1	1	1	1	1	
		2	2	2	2	2	2	2	2	2	2	2	2	2	2	2	2	2	

Time Code Source Setup Menu Selection Options

The Time Code Source Menu is used to determine the Time Code Source for each format. The CMN-41 can read LTC (Longitudinal Time Code) and DVITC (Digital Vertical Interval Time Code) based on the format selected. The Time Code Source menu has these selection options:

- **LTC** (default)
- **ANC LTC**
- **ANC DVITC 0**
- **ANC DVITC 1**
- **DVITC**: DVITC is monitored on selected lines. After DVITC is selected, adjust the line selection in the DVITC LINE 525 or DVITC LINE 625 submenus to the selected line. The range for DVITC LINE 525 is adjustable from Line 10 to 30, and DVITC LINE 625 is adjustable from line 6 to 30.

For more information on displaying time code see “Time Code” on page 79.

Waveform Setup Menu Selection Options

The Waveform Setup items are described below.

- **Display Format**: This selection option allows a choice of display formats: YCBCR (default), RGB, Composite, YCBCR + Alpha, and RGB + Alpha. **Table 5-17** lists the relationships between the input and display formats.

Table 5-17. Input and Display Format Relationship

Input Format	YCbCr	RGB	Composite	YCbCr + Alpha (10 bit only)	RGB + Alpha (10 bit only)
3Gb/s	Yes	Yes	Yes	Yes	Yes
HD	Yes	Yes	Yes	Yes	Yes
SD	Yes	Yes	Yes	No	No

- **Component Filter:** Component filters are used when the waveform display format is set to YCbCr or RGB. Filter selection options are Flat, Low Pass, and Bowtie.
 - **Flat:** No filtering (default)
 - **Low Pass:** Selects the Low Pass filter
 - **Bowtie:** Checks the timing relationships between the digital components (a bowtie test signal is required)
- **Composite Filter:** Composite filters are used when the waveform display format is set to Composite. Filter selections are Flat, Low pass, Chroma, and Flat and Low Pass.
 - **Flat:** No filtering (default)
 - **Low Pass:** Selects the Low Pass filter
 - **Chroma:** Selects the Chroma filter
 - **Flat and Low Pass:** Selects Flat and Low Pass filtering
- **Component Overlay:** When Component Overlay is selected for a single input, the components of the input signal are displayed over each other (that is, R over G over B in an RGB signal).
- **Blanking:** The blanking selections are Blank All, EAV/SAV, and Show All.
 - **Blank All** displays only the active video of the input signal (default).
 - **Show EAV/SAV** displays the active video and the EAV/SAV headers of the input signal.
 - **Show All** displays the ancillary data, EAV/SAV, and active video.
- **Error Highlighting:** Error highlighting changes the color of the portion of the waveform that exceeds the alarm settings. OFF is the default. The highlighting is dependent upon the format and gamut settings selected. The following are rules to consider:
 - Composite format with Flat filter follows the alarm settings for Gamut Peak upper and lower. It follows the threshold settings for the alarm, even when it is not enabled.
 - Composite format with Low Pass filter follows the Luma Upper and Lower thresholds.
 - Component format with RGB filter will follow the RGB gamut.
 - No highlighting in YCbCr.

- **Graticule:** This selection option is used to select the unit of measurement in percent or volts for the Digital Waveform Graticule, and in volts or units for the PAL Waveform Scale.
- **NTSC Pedestal:** This selection option adds setup to the Composite display (default).
- **Intensity:** This selection option is used to raise or lower the brightness of the displayed waveform. The range of intensity is 0% to 100%. The default waveform intensity is 72%.
- **Contrast:** This selection option is used to adjust the overall difference between the lightest and darkest colors of the waveform. The range of contrast is 0% to 100%. The default waveform contrast is 31%.
- **Persistence:** This selection option is used to determine how long a data point (pixel) in the waveform remains on the display. The range of persistence is 0% to Infinite. The default waveform persistence is 0%.
- **Attack:** Attack is the initial intensity that the data point (pixel) appears in the display. The range of attack is 1% to Maximum. The default waveform attack is 6%.

Vector Setup Menu Selection Options

The Vector Setup menu is used to select the Standard, IQ Lines, Scale to Composite, Intensity, Contrast, Persistence, and Attack. The Vector Setup selection options are described below.

- **Standard:** Standard is used to set the marks on the vector display. The marks on the vector help to visualize the minimum/maximum value of a video signal. The position of the excursion marks are 75% or 100% (default) for SD and HD. The HD standard also can be selected as 75% and 100% simultaneously.
- **I/Q Lines:** This selection option is used to turn OFF and ON the I and Q marker lines on the Vector Display. The default condition is OFF.
- **Scale to Composite:** The Scaled to Composite menu can be used to scale the SD or HD vector to reflect a composite format. The default condition is OFF.
- **Intensity:** This selection option is used to raise or lower the brightness of the displayed vector. The range of intensity is 0% to 100%. The default selection is 86%.
- **Contrast:** This selection option is used to adjust the overall difference between the lightest and darkest colors of the vector. The range of contrast is 0% to 100%. The default selection is 55%.
- **Persistence:** This selection option is used to determine how long a data point (pixel) in the vector remains on the display. The range of persistence is 0% to Infinite. The default selection is 0%.
- **Attack:** This selection option is used to determine the initial intensity that the data point (pixel) appears in the display. The range of Attack is 1% to Maximum. The default selection is 10%.

Gamut Setup Menu Selection Options

The Gamut Setup menu is used to change a gamut's color plots, Data Error Persistence, Intensity, Contrast, and Persistence. The Gamut Setup selection options are described below.

- **Single Color, RGB, Composite (Color Plot):** These selection options are used to set the color for plotting RGB pixels. The pixels can be one single color or RGB (red, green, or blue). Multiple colors help to indicate which color of the RGB signal moves beyond the inner and outer parameters of the gamut graticule. The default selection is RGB.
- **Data Error Persistence:** This selection option is used to determine how long a point of data beyond the inner and outer parameters of the gamut graticule. The range of persistence is 0% to Infinite. The default selection is 0%.
- **Intensity:** This selection option is used to raise or lower the brightness of the displayed gamut. The range of intensity is 0% to 100%. The default selection is 86%.
- **Contrast:** This selection option is used to adjust the overall difference between the lightest and darkest colors of the gamut. The range of contrast is 0% to 100%. The default selection is 55%.
- **Persistence:** This selection option is used to determine how long a data point (pixel) in the Gamut remains on the display. The range of Persistence is 0% to Infinite. The default selection is 0%.

Picture Setup Menu Selection Options

The Picture Setup selection options are described below. The default selection is Anamorphic.

- **Markers:** There are several markers available to be indicated in a picture.
 - **Center** is equal to 50% of the picture height and 50% of the picture width.
 - **Safe Title** is equal to 80% of the picture height and 80% of the picture width.
 - **Safe Action** is equal to 90% of the picture height and 90% of the picture width.
 - **Clean Aperture** shows the limits for the active pixel area. Brackets appear on the picture or a box surrounds the picture to show these limits. The center marker identifies the location of the center of the picture.
 - **Custom (Corners) and Custom (Box)** allows the setup of customized markers for a picture display.
 - **Custom Position** is used in conjunction with the Custom Corners and Custom Box selections. It allows the adjustment of the custom corner or box size.
 - **Custom Length** is used in conjunction with the Custom Corners selection option. It allows the adjustment of the corner lengths.
- **Anamorphic:** This selection option is used to correct the anamorphic display. Setting the menu selection to ON changes the actual source aspect ratio to an aspect

ratio that fills the screen (for example, SD squeezed horizontally 16×9 to 4×3 DVD source). The anamorphic selection is not available in 16×9 source aspect ratio.

- **Time Code:** This selection option is used to display the time code; that is, the time that is associated with each video frame. Time Code is keyed over the picture on the right side. Adjacent to the Time Code, the LTC/DVITC is keyed over the picture on the right side when Show LTC is selected. (Show LTC cannot be activated unless ENABLE is selected.) The Position selection option is used for the vertical placement of the time code at the top, center, and bottom (beyond safe action areas).
- **Brightness:** This selection option is used to make the picture brightness lighter or darker. The brightness range is from 0% (for the darkest picture) to 100% (for the brightest picture). The default picture brightness is 50%.
- **Contrast:** This selection option is used to increase the overall difference between the lightest and darkest colors. The contrast range is from 0% (for no difference between the lightest and darkest colors) to 100% (for the most amount of difference between the lightest and darkest colors). The default picture contrast is 100%.
- **Color:** This selection option is used to change the picture color gun selection. When all three colors are de-selected the picture display changes to monochrome.
 - **Green:** Green is a setup feature that is used to show the green color component of the input video. Use the Green feature to set the Saturation and Hue by matching the intensity of all green bars when a SMPTE split field color bar signal is applied.
 - **Blue:** Blue is a setup feature that is used to show the blue color component of the input video. Use the Blue feature to set the Saturation and Hue by matching the intensity of all blue bars when a SMPTE split field color bar signal is applied.
 - **Red:** Red is a setup feature that is used to show the red color component of the input video. Use the Red feature to set the Saturation and Hue by matching the intensity of all red bars when a SMPTE split field color bar signal is applied.
- **VBI Mask:** The VBI (Vertical Blanking Interval) Mask selection option is used to mask non-active lines. With VBI Mask set to ON, only active lines will be shown on the picture portion of the display.
- **Native:** When this selection option is enabled, it displays the SD picture as a one-for-one pixel mapping. When Native mode is not checked, the SD picture fills the screen.

NOTE: The Native mode menu item only appears when an SD format is detected or selected.
- **Delay:** This selection option is used to view the horizontal and vertical blanking areas of the video signal. Delay enables and disables the delay mode. Delay Position displays the amount of vertical and horizontal delay. Using the Delay position, turn the Up/Down and Right/Left knobs to position the picture. The Delay feature is not affected by the Native mode selection.
- **Gamut Error Highlighting:** When Gamut Error Highlighting is selected in the Picture setup menu, a grid pattern appears over the picture display highlighting gamut errors. Gamut highlighting is determined by the gamut threshold settings in the ALARMS → VIDEO ALARMS → GAMUT selection option.

Audio Setup Menu Selection Options

The Audio Setup selection options are described below.

- **2 Channels:** This selection option allows the display of one 2-channel bar graph with one lissajous and one phase bar.
- **4 Channels:** This selection option allows the display of two 2-channel bar graphs (for a total of four channels) with two lissajous and two phase bars.
- **6 Channels:** This selection option allows the display of three 2-channel bar graphs (for a total of six channels) with three phase bars, or CineSound 5.1 with two phase bars
- **8 Channels:** This selection option allows the display of four 2-channel bar graphs (for a total of eight channels) with eight phase bars; CineSound 5.1 with two phase bars; CineSound 6.1 with two phase bars, or CineSound 7.1 with three phase bars
- **16 Channels:** This selection option allows the display of eight 2-channel bar graphs (for a total of 16 channels) with eight phase bars
- **Meter Setup:** This selection option is used to select the response, ballistics, and other meter features.
 - **Ref Level:** This selection option is used to set the reference level on the meters for a digital signal. The range is from -8 dBFS to -22 dBFS. The default selection is -20 dBFS. Content below this setting is green. Content above this setting is yellow.
 - **Peak Program Level:** This selection option is used to adjust the position of the peak marker on an Audio meter display. Value is the number of dB above the reference level. Content above this value is red.
 - **Scale:** This selection option is used to determine the type of scale that appears on the Audio meter display. Custom dBFS and Custom dB can customize the top and bottom of the dBFS or dB scales.
 - **Zoom:** This selection option is used to set the Zoom modes. Selections are Center at Reference Level, Center at dB level, and Zoom Range. The Center at dB level has a range from -60 dB to $+20$ dB; the default selection is 0 dB. The Zoom range is from 4 dB to 20 dB; the default selection is 10 dB.
 - **Peak Hold Time:** This selection option is a user-selectable duration value of Off, 1 to 10 seconds, or Infinite. The duration only applies to the hold time of the PEAK value, not the attack or decay time. The default selection is Off.
 - **Meter Labels:** This selection option menu is used to select the audio mapping scheme for the selected input. Only the Vertical Bar Meter labels can be customized. When the CineSound display is selected, the audio inputs follow a SMPTE 320M mapping scheme. For vertical meters only, the SMPTE 320M meter label-mapping scheme can be changed to a stereo pair-mapping scheme or Custom Labels.
 - **LFE Offset:** This selection option adjusts the LFE by -10 dB when enabled. LFE Offset only occurs when CineSound is displayed.
 - **CineSound Direction:** This selection option is used to reverse the default meter movement for the CineSound display. The default selection for the CineSound

direction is from the center outward. Select INWARD to reverse the meter movement.

- **Audio Markers:** This selection option is used to place adjustable markers in the audio meters. Adjustable markers can be placed in audio meters to show specific critical levels.
- **Meter Response:** This selection option is used to display the selected meter response. Options are VU, Peak, True Peak, VU + Peak, VU + True Peak, Loudness, Custom, Custom Attack, and Custom Decay. The default selection is VU.
- **Lissajous Setup:** This selection option is used to set up the display amplitude and phase relationships between two input signals. Options are Persistence, Attack, AGC, and Plot.
 - **Persistence:** This selection option is used to determine how long a data point (pixel) remains on the display. The range of Persistence is 0% to Infinite. The default selection is 0%.
 - **Attack:** This selection option is the initial intensity that the data point (pixel) appears in the display. The range of Attack is 1% to Maximum. The default selection is 50%.
 - **Automatic Gain Control:** This selection option is used to keep the display visible from very small levels to very high levels.
 - **Plot:** This selection option is used to select one of two types of Lissajous displays. The soundstage selection displays a Lissajous that is rotated so that the in-phase signals appear on the vertical axis and out of phase signals appear on the horizontal axis. X-Y displays a Lissajous with the left channel mapped to the vertical axis, and the right channel mapped to the horizontal axis.
- **Configure Phase Bar(s):** Phase bars are used to monitor the instantaneous phase relationship between two channels of audio. On a vertical audio display the “+” marking indicates a phase difference of 0°, and the “-” marking indicates a phase difference of 180°. A properly phased stereo pair produces a phase pointer that moves within the green zone, whereas a reversed channel produces a pointer that moves within the red zone.
 - **Polarity:** This selection option is used to set the phase bar polarity to Normal or Reverse. The default selection is Normal.
 - **Damping:** The effect of higher damping in a phase meter is to show an averaged rather than a peak value of phase. This selection option is used to set the phase bar damping to Fast, 1 to 10, or Slow. The default selection is 5.
- **AES Validity Bit:** The AES Validity Bit is used to detect pulse code modulation (PCM) audio or non PCM audio. Non-PCM audio can include Dolby or other digital data.

Timing Setup Menu

The Timing Setup menu is used to set the offset of the reference to the signal. The Timing Setup selection options are described below; the default selection is Factory.

- **Reference:** This selection option is used to set the reference source.
 - **External REF** – This selection option uses the blackburst or tri-level signal connected to the External Reference input.
- **Factory:** This selection option is used to set the factory reference to 0. When FACTORY is selected, the OFFSET field does not appear on the screen.
- **Offset:** This selection option Enables and displays the Offset field. The reference offset is not applied until Set Zero Ref is selected.
- **Set Zero Ref:** This selection option is used to apply the current offset setting as the zero reference point.

OPT Setup Menu Selection Options

The OPT, or Options, setup menu is used to select Longitudinal Time Code (LTC) or Reference Waveform.

MLT Setup Menu Selection Options

The MLT Setup menu is used to set up selection options for the Overlay display mode. Selection options include Intensity, Contrast, Persistence, and Attack.

- **Intensity:** This selection option is used to raise or lower the brightness of the displayed waveform and vector. The range of intensity is 0% to 100%. The default selection is 72%.
- **Contrast:** This selection option is used to adjust the overall difference between the lightest and darkest colors of the displayed waveform and vector. The range of contrast is 0% to 100%. The default selection is 31%.
- **Persistence:** This selection option is used to determine how long a data point (pixel) in the displayed waveform and vector remains on the display. The range of persistence is 0% to Infinite. The default selection is 0%.
- **Attack:** Attack is the initial intensity that the data point (pixel) appears in the display. The range of attack is 1% to Maximum. The default selection is 6%.

Alarms Setup Menu

For information on alarm setup and descriptions, see Section 6.

Import/Export Menu

The Import/Export selection options are described below.

- **Import:** This selection option is used to retrieve display captures saved to a USB device via the File Navigator dialog box. For more information on the File Navigator dialog box, see page 87.

- **Export:** This selection option is used to save display captures to a USB device via the File Navigator dialog box. For more information on the File Navigator dialog box, see page 87.

NOTE: The File Navigation screen appears only when a USB drive is attached to the CMN-41 unit. See “File Navigator” on page 87 for more information.

Clear Setup Menu

The Clear Setup menu is associated with all unit operations that allow an instantaneous clear of the active function. The Clear Setup selection options are described below.

- **DISP Captures:** This selection option is used to clear a display capture from the CMN-41 unit’s memory.
- **SDI Captures:** This selection option is used to clear an SDI capture from the CMN-41 unit’s memory.
- **Audio Peak Hold:** This selection option is used to clear the peak audio hold.
- **Alarm Log:** This selection option is used to clear the alarm log.
- **Alarm Error Count:** This selection option is used to clear an alarm status.
- **Timing Zero Reference:** This selection option used to clear the timing zero reference.
- **Persistence:** This selection option is used to clear the waveform or vector infinite persistence.

Unit Configuration Display Setup Menu

The Unit Configuration Display Setup selection options are described below.

- **Display Setup:** The Display Setup selection options are used to configure the display colors, aspect ratio, sleep mode, screen saver, and monochrome display.
 - **Input Color:** This selection option is used to select the color for the waveform and vector displays. Color selections are blue, green, cyan, red, magenta, brown, gray, dark gray, light blue, light green, light cyan, light red, light magenta, yellow, and white. The default selection is light green. Use the curved arrow knob to scroll through the available color selections.
 - **Graticule Color:** This selection option is used to select the color for the graticule display items. Color selections are blue, green, cyan, red, magenta, brown, gray, dark gray, light blue, light green, light cyan, light red, light magenta, yellow, and white. The default selection is white. Use the curved arrow knob to scroll through the available color selections (you will see the colors change on the display screen).
 - **Cursor Color:** This selection option is used to select the color for the cursor display items. Color selections are blue, green, cyan, red, magenta, brown, gray, dark gray, light blue, light green, light cyan, light red, light magenta, yellow, and white. The default selection is light red. Use the curved arrow knob to scroll through the available color selections (you will see the colors change on the display screen).

- **Aspect Ratio:** This selection option is used to indicate to the CMN-41 instrument the format of the monitor that is utilizing the signal from the DVI OUT port. The menu selection should always match the actual aspect ratio of the monitor. When the aspect ratio is correctly set, the vector display graticule will appear round instead of oval.
- **Sleep Mode:** This selection option is used to turn off all LEDs and the display after there is no activity for the specified duration. In Sleep mode the CMN-41 is still active (that is, alarms still triggered, etc.) The time it takes for Sleep mode to activate can range from 1 to 60 minutes.
- **Monochrome Display:** This selection option is used to provide a black-and-white display output.
- **Graticule Intensity:** This selection option is used to raise or lower the brightness of the displayed graticule. The range of graticule intensity is 1% to 100%. The default selection is 50%.
- **Cursor Intensity:** This selection option is used to raise or lower the brightness of the displayed cursor. The range cursor intensity is 1% to 100%. The default selection is 100%.
- **Front Panel:** This selection option is used to raise or lower the brightness levels of the front panel function buttons, and to select the intensity of the display background.
 - **High Tally:** This selection option is used to set the brightness of the High Tally state. The brightness of the high tally state is determined by the contrast and brightness of the low tally state. The range of button contrast is 35% to 100%. The default selection is 80%.
 - **Low Tally:** This selection option allows for setting the brightness of the buttons in a low tally state. The range of brightness is 0% to 10%. The default selection is 5%.
- **GPIO:** The GPIO selection options are described below
 - **Input Function:** This selection option is used to configure the GPIOs. There are selectable functions to allow external control of the unit or to show an onscreen alarm.
 - **Output Function:** This selection option is used to determine the GPO Polarity and GPO Setup for each input.

GPO Polarity

There is one OUTPUT GPI that is associated with a list of alarms. All GPO alarm activation selections are set to the default OFF until the alarm is enabled. When an alarm is enabled, the GPO functions according to the GPO POLARITY setting (NORMALLY OPEN, NORMALLY CLOSED). The default polarity is NORMALLY OPEN.

- NORMALLY OPEN: The contact closure on the GPO board is normally open. When the contact closure closes, the GPO alarm is activated.
- NORMALLY CLOSED: The contact closure on the GPO board is normally closed. When the contact closure opens, the GPO is activated.

GPO Setup

The GPO Setup is used to select what input or alarm the GPO follows. If an alarm occurs on an input associated with the GPO, the GPO will change its polarity setting. If Follow Alarms is selected, the GPO will change its polarity setting whenever an alarm occurs on any input.

- **IP Configuration:** The IP configuration selection option is used to configure the CMN-41 for Ethernet communication. The Ethernet interface provides a high-speed communication link to the third party applications (such as SNMP) over standard LAN and Internet networks. The interface conforms to industry Ethernet standards:
 - Connection via a standard RJ45 socket
 - Automatic detection and switching between 10Base-T and 100Base-T
 - TCP/IP stack is fully compliant with RFC2500, “Internet Official Protocol Standards”
 - Fully compliant with IEEE 802.3 Ethernet standard

The interface can accept a static IP address, or it can obtain an IP address dynamically from a DHCP server. The IP Address, Subnet Mask, Gateway Address, DHCP enable, and Port are programmable from the unit’s Ethernet Setup menu. The settings are performed in the IP Configuration screen.

- DHCP: The Dynamic Host Configuration Protocol (DHCP) function is used to have the CMN-41 automatically configure an IP Address, Subnet Mask, and Gateway every time the unit is powered on. The IP Address is dynamic and could change each time the CMN-41 is powered on. DHCP Enable is set to OFF by default.
 - IP Address: The IP Address is used to select a static IP address (unless DHCP will be used). The IP address must not be the same address as another instrument or PC on the network. Network conflicts will occur if two devices have the same IP address. See the System Administrator to determine a static IP address that will avoid conflicts.
 - Subnet Mask: The Subnet Mask is used to configure the Subnet Mask on a network if DHCP is not enabled. If DHCP is not used to automatically detect the Subnet Mask on a network, the Subnet Mask must be manually configured. Unlike the IP address, the Subnet Mask must be the same Subnet Mask as the network Subnet Mask. See the System Administrator to determine the Subnet Mask.
 - Gateway: The Gateway is the network address that provides access to an outside network. Use the Gateway submenu to configure the Gateway on a network if DHCP is not enabled. If DHCP is not used to automatically detect the Gateway on a network, the Gateway must be manually configured. Unlike the IP address, the Gateway must be the same Gateway address as the network Gateway address. See the System Administrator to determine the Gateway address.
- **System Time:** This selection option allows the setup of the clock display’s date and time.

- **Show Clock:** This selection option allows the display of the system clock.
- **Flash Update from USB:** This selection option is used in coordination with a USB memory stick to update the unit.
 - Attach the USB stick into the unit.
 - Select Flash Update from USB in the Unit Configuration menu.
 - Use the File Navigator to select the FLU file.
 - Press the ENT button to proceed into flash update mode. Flash update status is shown on the front panel screen.

When complete, “FLASH UPDATE COMPLETE” appears on the screen.

 - Cycle the power to continue normal operation.

NOTE 1: Presets are lost when performing a flash update. Ensure that the presets are saved on USB before flashing.

NOTE 2: This menu item will not appear if a USB memory device is not installed.

- **Feature Upgrade from USB:** This selection option is used in coordination with a USB memory stick containing the feature file for the device to update the unit.
 - Attach the USB stick into the unit.
 - Select Feature Update from USB in the Unit Configuration menu.
 - Use the File Navigator to select the update file.
 - Press the ENT button to proceed into feature upgrade mode.

When complete, the screen blanks and the unit reboots.

 - In the Setup menu, select ABOUT to verify the option was installed successfully.

NOTE: The serial number on the device must match the serial number on the feature file. The message “INSERT USB DEVICE WITH FEATURE UPGRADE” appears when the serial number of the device does not match the serial number on the feature file.

About Display Screen

This selection option allows the display of the About screen (see **Figure 5-2**). The About screen contains the model, serial number, module, device, and version. Press the EXIT navigation to exit from the screen.

Figure 5-2. About Display Screen

Model Number	CMN-41
Serial Number	070900410
Options	SD HD 3 Gig
Front Panel Rev.	1.13
Firmware Rev.	1.12 u
FPGA Rev.	1.12 u
CPLD Rev.	14
PCB Rev.	0.01
Qt Rev.	4.5.0.1
File System Rev.	1.14
OS Rev.	Sat Jun 20 13:32:29 EDT 2009 f
Boot Rev.	Jun 12 2009 - 07:35:58
IP Address	137.237.182.227
MAC Address	00:04:B3:00:3A:21
<input type="button" value="Exit"/>	

File Navigator

NOTE: The File Navigator dialog box does not appear if a USB removable drive is not connected to the USB port on the unit.

The File Navigator dialog box is used to control the presets and frame captures for the CMN-41. Any stored preset or frame capture can be stored onto the USB removable drive. In addition, any preset or frame capture stored on the USB drive can be stored in the CMN-41's internal memory. Use the Import/Export selection option to access the File Navigator dialog box, shown in **Figure 5-3**.

Figure 5-3. File Navigator Dialog Box

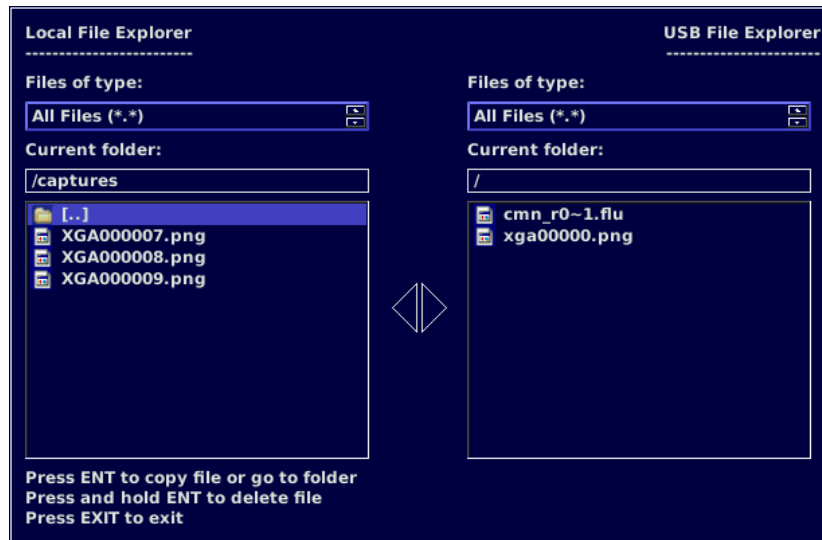

- The left column of the File Navigator dialog box, labeled as Local File Explorer, shows what is available to be transferred to the USB drive. The stored presets are located in the PRESETS folder, and the frame captures are located in the

CAPTURES folder. Use the navigation buttons to move between the folders and files. Press the ENT button to enter a folder.

- The right column of the File Navigator dialog box, labeled as USB File Explorer, shows what is stored on the USB memory device. The stored presets and captures on the USB drive are shown in this column.

When a preset or capture is selected, press the ENT button to copy the file over to the USB drive or internal memory. Press and hold the ENT button to delete the file. Press the EXIT button to exit.

Section 6 ♦ Alarm Descriptions

Setting Alarms

The CMN-41 alarms monitor video and audio signals, time code errors, and GPI errors.

Limits are selected in the Setup menu by choosing a value using the curved arrow knob or the Up/Down navigation buttons.

Sensitivity and Duration are two general terms used in the alarm menus.

- Sensitivity is set by Consecutive Errored Samples (CES). When setting amplitude limits, a noise spike can exceed the limit while the video amplitude can be within the limit. With the CES set to a low number, a spike is detected and an alarm is displayed. Set the CES to a higher number to ignore the fast spike. Each CES occurs at 37ns intervals for SD and 13.5ns for HD. Use this as a guideline to select the appropriate CES value.

Not all alarms have CES associated with them; in such cases, use the duration to increase or decrease the general sensitivity.

- Duration is used to determine how long an error must persist before it is reported. Set the duration to 0 to cause an error to be displayed as soon as the CES value is met.

Alarm Setup Menus

The Alarm Setup menu items, along with their corresponding Table and Description page locations are listed in **Table 6-1**. An asterisk (*) is shown next to the default menu selections.

Table 6-1. Alarms Setup Menu

Selection	Table Page	Description Page
Video alarms	89	94
Audio alarms	92	96
Time code alarms	93	96
GPI Alarms	94	97

NOTE: See page 63 for information on how to navigate through the Setup menus.

Table 6-2. Video Alarms Setup Menu

NOTE: Descriptions for these selection options start on page 94.

Selection	Selection Option	Selection Option	Selection Option
Format Change			
Payload Identifier Mismatch			

Table 6-2. Video Alarms Setup Menu**NOTE:** Descriptions for these selection options start on page 94.

Selection	Selection Option	Selection Option	Selection Option
Loss of Carrier	Enable		
	Duration	0 to 60 seconds (2 seconds *)	
Loss of Reference	Enable		
	Duration	0 to 60 seconds (2 seconds *)	
Loss of Active Video	Enable		
	Threshold	0 to 350 mV (300 mV *)	
	Sensitivity	2 * to 20 CES	
	Duration	0 to 60 seconds (2 seconds *)	
Loss of Payload Identifier	Enable		
	Duration	0 to 60 seconds (2 seconds *)	
Gamut	RGB Gamut Upper	Enable	
		Threshold	650 to 750 mV (710 mV *)
		Sensitivity	1 to 20 CES (15 CES *)
		Duration	0 to 60 seconds (2 seconds *)
	RGB Gamut Lower	Enable	
		Threshold	-50 to 50 mV (-10 mV *)
		Sensitivity	1 to 20 CES (15 CES *)
		Duration	0 to 60 seconds (2 seconds *)
	Luminance Gamut Upper	Enable	
		Threshold 525/59.94	90 to 108 IRE (105 IRE *)
		Threshold 625/50	92 to 109 Units setting (107 Units *)
		Sensitivity	1 to 20 CES (15 CES *)
		Duration	0 to 60 seconds (2 seconds *)
	Luminance Gamut Lower	Enable	
		Threshold 525/59.94	1.5 * to 20 IRE
		Threshold 625/50	-7 to 20 Units setting (-4 Units *)
Sensitivity		1 to 20 CES (15 CES *)	
Duration		0 to 60 seconds (2 seconds *)	

Table 6-2. Video Alarms Setup Menu

NOTE: Descriptions for these selection options start on page 94.

Selection	Selection Option	Selection Option	Selection Option
	Peak Gamut Upper	Enable	
		Threshold 525/59.94	50 to 140 IRE (120 IRE *)
		Threshold 625/50	51 to 143 Units + mV setting (123 Units *)
		Sensitivity	1 to 20 CES (15 CES *)
		Duration	0 to 60 seconds (2 seconds *)
	Peak Gamut Lower	Enable	
		Threshold 525/59.94	-40 to 0 IRE (-20 IRE *)
		Threshold 625/50	-40 to 0 Units + mV setting (-20 Units *)
		Sensitivity	1 to 20 CES (15 CES *)
		Duration	0 to 60 seconds (2 seconds *)
CRC-HD	Enable		
	Duration	0 to 60 seconds (2 seconds *)	
EDH-SD	Enable		
	Duration	0 to 60 seconds (2 seconds *)	
Letterbox-SD	Enable Top Border		
	Top Border 525/59.94	Line 21 * to Line 139	
	Top Border 625/50	Line 19 * to Line 159	
	Enable Bottom Border		
	Bottom Border 525/59.94	Line 140 * Line to 262	
	Bottom Border 625/50	Line 160 * to Line 312	
	Threshold	10 to 350 mV (286 mV *)	
	Duration	0 to 60 seconds (2 seconds *)	
Pillarbox-HD	Enable Left Border		
	Left Border	Pixel 1 * to 860	
	Enable Right Border		
	Right Border	Pixel 861 to 1920 *	
	Threshold	10 to 350 mV (286 mV *)	
	Duration	0 to 60 seconds (2 seconds *)	
Picture Shift	Enable		
	Threshold	0 to 350 mV (2 mV *)	
	Vertical	1 to 200 lines (2 lines *)	
	Horizontal	1 to 300 pixels (2 pixels *)	

Table 6-2. Video Alarms Setup Menu

NOTE: Descriptions for these selection options start on page 94.

Selection	Selection Option	Selection Option	Selection Option
Timing	Enable		
	Lines	0 to 50 lines (1 line *)	
	Microseconds	1 to 64 μ s (1 μ s *)	
	Duration	0 to 60 seconds (2 seconds *)	

Table 6-3. Audio Alarms Setup Menu

NOTE: Descriptions for these selection options start on page 96.

Selection	Selection Option	Selection Option
Peak Audio	Enable Channel 1 • • Enable Channel 16	
	Level	-30 to 0 dBFS (-10 dBFS *)
	Duration	0 to 60 seconds (2 seconds *)
	Phase	
Phase	Enable Pair 1 • • Enable Pair 8	
	Value	0 degrees to 178 degrees *
	Duration	0 to 60 seconds (2 seconds *)
Loss of Sound	Enable Channel 1 • • Enable Channel 16	
	Level	-60 * to 0 dBFS
	Duration	0 to 60 seconds (2 seconds *)
	Loss of AES Data	
Loss of AES Data	Enable	
	Duration	0 to 60 seconds (2 seconds *)
Loss of Embedded Data	Enable Group 1 Pair 1	
	Enable Group 1 Pair 2	
	Enable Group 2 Pair 1	
	Enable Group 2 Pair 2	
	Enable Group 3 Pair 1	
	Enable Group 3 Pair 2	
	Enable Group 4 Pair 1	
	Enable Group 4 Pair 2	
	Duration	0 to 60 seconds (2 seconds *)
Continuous Tone	Enable Channel 1 • • Enable Channel 16	
	Threshold	1 * to 20 dB
	Duration	0 to 60 seconds (2 seconds *)

Table 6-3. Audio Alarms Setup Menu**NOTE:** Descriptions for these selection options start on page 96.

Selection	Selection Option	Selection Option
Audio Clip	Enable Channel 1 • • Enable Channel 16	
	Sensitivity	1 to 100 CES (50 CES *)
	Duration	0 to 60 seconds (2 seconds *)
Audio Mute	Enable Channel 1 • • Enable Channel 16	
	Sensitivity	1 to 100 CES (50 CES *)
	Duration	0 to 60 seconds (2 seconds *)
AES/EBU V-Bit	Enable	
	Duration	0 to 60 seconds (2 seconds *)
Embedded V-Bit Data	Enable Group 1 Pair 1	
	Enable Group 1 Pair 2	
	Enable Group 2 Pair 1	
	Enable Group 2 Pair 2	
	Enable Group 3 Pair 1	
	Enable Group 3 Pair 2	
	Enable Group 4 Pair 1	
	Enable Group 4 Pair 2	
	Duration	0 to 60 seconds (2 seconds *)
Low Audio	Enable Channel 1 • • Enable Channel 16	
	Level	-60 * to 0 dBFS
	Duration	0 to 60 seconds (2 seconds *)
BCH	Enable	
	Duration	0 to 60 seconds (2 seconds *)

Table 6-4. Time Code Alarms Setup Menu**NOTE:** Descriptions for these selection options start on page 96.

Selection Option	Selection Option	Selection Option
LTC Loss of Time Code	Enable	
	Duration	0 to 600 seconds (240 seconds *)
LTC Time Code Level	Enable	
	Range	0.2 to 1.8 volts (0.5 volts *)
	Duration	0 to 600 seconds (240 seconds *)
LTC Time Code Framing	Enable	
	Range	1.5 to 10.5 * lines
	Duration	0 to 600 seconds (240 seconds *)
LTC Time Code Continuity		

Table 6-4. Time Code Alarms Setup Menu

NOTE: Descriptions for these selection options start on page 96.

Selection Option	Selection Option	Selection Option
LTC/DVITC Compare	Enable	
	Threshold	1 * to 30 frames
	Duration	0 to 600 seconds (240 seconds *)
DVITC Loss of Time Code	Enable	
	Duration	0 to 600 seconds (240 seconds *)
D-VITC Line	Enable	
	Line Number – 525/59.94	Line 10 to Line 30 (Line 14 *)
	Line 625 – 625/50	Line 6 to Line 30 lines (Line 14 *)
	Duration	0 to 600 seconds (240 seconds *)
D-VITC Continuity		
D-VITC CRC	Enable	
	Duration	0 to 600 seconds (240 seconds *)

Table 6-5. GPI Alarms Setup Menu

NOTE: Descriptions for these selection options start on page 97.

Selection Option
GPI 1 Alarm Enable *
GPI 2 Alarm Enable *
GPI 3 Alarm Enable *
GPI 4 Alarm Enable *

Video Alarms Setup Descriptions

The Video Alarms Setup menu contents are listed below.

- **Format Change:** The Format Change alarm is used to indicate that the incoming video format has changed.
- **Payload ID Mismatch:** The Payload Identifier Mismatch alarm is used to indicate that the payload indicated in a SMPTE 352M ancillary data packet does not match the detected input format such as HD/SD and frame rate.
- **Loss of Carrier:** The Loss of Carrier alarm occurs when there is no Timing Reference Signal (TRS) detected.
- **Loss of Reference:** The Loss of Reference alarm occurs when no sync signal is detected in the external reference for a period in excess of the duration setting. (For more information necessary to select the appropriate external reference, see page 82.)
- **Loss of Active Video:** The Loss of Active Video occurs when active video falls below the adjustable threshold for a period in excess of the duration setting.
- **Loss of Payload ID:** The Loss of Payload ID alarm is used to indicate when the SMPTE 352M Video Payload ID ancillary data packet is not detected in the received data stream for a period in excess of the duration setting.

- **Gamut:** Gamut alarms are used to indicate when components of an RGB, Luma, or peak signal fall outside upper or lower preset limits.
 - **RGB Gamut Upper/Lower:** The RGB Upper and Lower alarm occurs when any component of the transcoded RGB signal falls outside the upper or lower limits for a period in excess of the duration setting. The Sensitivity can be increased to provide immunity to fast transcoding spikes.
 - **Luminance Gamut Upper/Lower:** The Luminance Upper and Lower alarms scan the composite encoded signal derived from the selected digital input. The alarms occur when the luminance video falls outside the adjustable limits for a period in excess of the duration setting. The Sensitivity can be increased to provide immunity to fast noise spikes.
 - **Peak Gamut Upper/Lower:** The Peak Upper and Lower alarms scan the composite encoded signal derived from the selected digital input. The alarm occurs when the peak video falls outside the adjustable limits for a period in excess of the duration setting. The Sensitivity can be increased to provide immunity to fast noise spikes.
- **CRC-HD:** The CRC-HD alarm occurs when the internally calculated CRC value is different from the received CRC value.
- **EDH – SD:** Per SMPTE RP 165-1994; the EDH-SD alarm occurs when one or more errors are detected for a period in excess of the duration setting.
- **Letterbox – SD:** The Letterbox is the top and bottom border surrounding the active video. The top border is defined as having video below the threshold on the set line and having video above on the following line. The bottom border is defined as having video above the threshold on the previous line and video below the threshold on the set line. The Letterbox SD alarm is activated when either the top line or the bottom line deviates from the user settings (Standard Definition only).
- **Pillarbox – HD:** The PillarBox is the border to the right and left of the active video. The “End of Left Border” and “Start of Right Border” defines the set points when the video is below the threshold. If the video is outside of the threshold and CES values for the specified duration, the Pillar Box HD alarm occurs (High Definition only).
- **Picture Shift:** The Picture Shift alarm activates when the luma portion of the video does not exceed the amplitude threshold along any of the four borders of active video. The “Left/Right” and “Top/Bottom” border settings define the tolerance of the Picture Shift alarm. If one or more pixels are above the threshold for each of the four tolerance borders, no alarm will be declared. For interlaced video formats Picture Shift checks the first field only. For example, if a signal is 525/59.94 SDI video format, where “Left/Right” is set to 20 pixels, “Top/Bottom” is set to 4 lines, the threshold is set to 2 mV, and the “Duration” is set to 2 seconds, the alarm will be activated if pixels 1 through 20 or 701 through 720, or lines 1 through 4, or 240 through 244 of active video do not exceed the 2 mV threshold and exceeds the duration of 2 seconds.
- **Timing:** The Timing Alarm occurs when the Time and Line range(s) are exceeded for a period in excess of the duration setting.

Audio Alarms Setup Descriptions

The Audio Alarms Setup menu contents are listed below.

- **Peak Audio:** The Peak Audio alarm occurs when the peak audio level exceeds the adjustable limit for a period in excess of the duration setting. The limit can be set from -30 dBFS to 0 dBFS, in 1 dB increments.
- **Phase:** The Phase alarm occurs when the phase difference between any audio pair (L and R) exceeds an adjustable range for a period in excess of the duration setting. The range is 0 to 178 degrees, in 1 degree increments. The range is a global setting. If eight channels (four pairs) are displayed, the setting is valid for all pairs.
- **Loss of Sound:** The Loss of Sound alarm occurs when the peak amplitude falls below an adjustable limit for a period in excess of the duration setting. This alarm is valid for the displayed input (AES/EBU or embedded). The audio range is -60 dBFS to 0 dBFS, in 1 dB increments. The range point is global and is independent of the scale type or input format.
- **Loss of AES Data:** The Loss of AES Data alarm monitors the AES/EBU data stream. The alarm occurs when a loss of data is detected for a period in excess of the duration setting.
- **Loss of Embedded Data:** The Loss of Embedded Data alarm monitors the Embedded data stream. The alarm occurs when a loss of embedded data is detected for a period in excess of the duration setting.
- **Continuous Tone:** The Continuous Tone alarm occurs when a continuous sound level is present for a period in excess of the duration setting.
- **Audio Clip:** The Audio Clip alarm occurs when the digital audio is at a maximum level for a period in excess of the duration setting. The Audio Clip indicator appears in the table below the audio meters when an Audio Clip alarm occurs. For the CMN-41, the accuracy of the audio clip alarm is 0.1 dB.
- **Audio Mute:** The Audio Mute alarm occurs when the audio sample is “0” for a period in excess of the duration settings. The Audio Mute indicator appears in the table below the audio meters when an Audio Mute alarm occurs.
- **AES/EBU V-Bit:** The V-Bit alarm occurs when the V-Bit is detected as “1” in the audio AES source for the specified duration.
- **Embedded V-Bit Data:** The Embedded V-Bit alarm occurs when the V-Bit is detected as “1” in the embedded audio source for the specified duration.
- **Low Audio:** The Low Audio alarm occurs when the peak audio sample does not exceed the adjustable digital level for a period of time in excess of the duration setting. The peak audio sample is an absolute measurement of the audio sample and represents the true audio peak. It is not averaged over time, and can be enabled per channel.
- **BCH:** The BCH alarm occurs when errors are detected in an HD embedded audio packet

Time Code Alarms Setup Descriptions

The Time Code Alarms Setup menu contents are listed below.

- **LTC Loss of Time Code:** The Loss of Time Code alarm occurs when the peak-to-peak level of the LTC input signal falls below an adjustable limit for a period in excess of the duration setting.
- **LTC Time Code Level:** The Time Code Level alarm occurs when the peak-to-peak level of the LTC input signal falls outside the user defined range limits for a period in excess of the duration setting.
- **LTC Time Code Framing:** The Time Code Framing alarm occurs when the alignment of the start of LTC (ANSI/SMPTE 12M-1999) exceeds the range limit for a period in excess of the duration setting.
- **LTC Time Code Continuity:** The Time Code Continuity alarm occurs when a break or interruption in the time-code count occurs.
- **LTC/DVITC Compare:** The LTC/DVITC alarm occurs when LTC and DVITC are compared and differ beyond the threshold (1 to 30 frames) selection for a period in excess of the duration setting.
- **DVITC Loss of Time Code:** The DVITC Loss of Time Code alarm occurs when no DVITC Time Code in the video signal is detected for a period in excess of the duration setting.
- **D-VITC Line:** The D-VITC Line alarm is used to select the line number on which the D-VITC time code is detected for the “D-VITC Continuity” and “D-VITC CRC” fields. When time code is not detected on the selected line number, the alarm activates.
- **D-VITC Continuity:** The D-VITC Continuity alarm occurs when a break or interruption in the digital vertical interval time code (VITC) frames occur for a period in excess of the duration setting.
- **D-VITC CRC:** The D-VITC CRC alarm occurs when the cyclic redundancy check (CRC) within the digital vertical interval time code field does not correlate with the calculated CRC for a period in excess of the duration setting.

GPI Alarms

The input GPIs have selectable functions. There are selectable functions to allow external control of the unit or to show an onscreen alarm.

Alarm Log

The Alarm Log selection option enables the Alarm Log display. The Alarm Log display lists all the alarms, the date, time, time code, duration, and peak value. The alarm list begins with the most recent alarm and can hold a maximum of 100 alarms.

An Alarm Log display diagram is shown in **Figure 4-34** on page 55 and described in **Table 4-14**. The diagram illustrates the general location for the various alarm fields.

When an alarm is first registered, it appears on the Alarm Log display and is highlighted in yellow. If the alarm is short term (that is, two seconds or less), the alarm text is not highlighted after approximately two seconds. If the alarm continues longer than two seconds, the text remains yellow and the alarm duration is incremented. When the next alarm occurs, the previous alarm moves down one position.

Alarm Status

The alarm status screen contains detailed information concerning alarm status indicators. This information is separated into columns sorted by alarm name, whether or not the alarm is enabled, lower and upper limits, thresholds, and duration, and total number of alarms. The alarm name text can appear in a colored state. The colored states are:

- **White:** indicates alarm is not enabled.
- **Green:** indicates alarm is enabled and not exceeding alarm limits.
- **Red:** indicates the alarm is enabled and exceeding an alarm limits.

There is a two-second persistence for any Alarm Name color change.

Use the same navigation buttons to scroll through the alarm status list as for the alarm log list (see page 55).

An alarm status display diagram is shown in **Figure 4-35** on page 56. The diagram illustrates the general location for the various alarm status display fields.

Section 7 ♦ External Control

Browser Interface

NOTE: Microsoft® Internet Explorer version 7 is the recommended browser.

The website for each unit is accessed by pointing the web browser at the CMN-41 IP address. Before the default web screen appears, a user ID and password must be entered to access the instrument.

- User ID: **admin**
- Password: **Harris**

Once the user ID and password have been entered, the web page appears, showing a list of captures that have been stored in the CMN-41's internal memory. Use the web page to view the files or save them to disk. A sample web page is shown in **Figure 7-1**.

Figure 7-1. Sample Web Remote Display

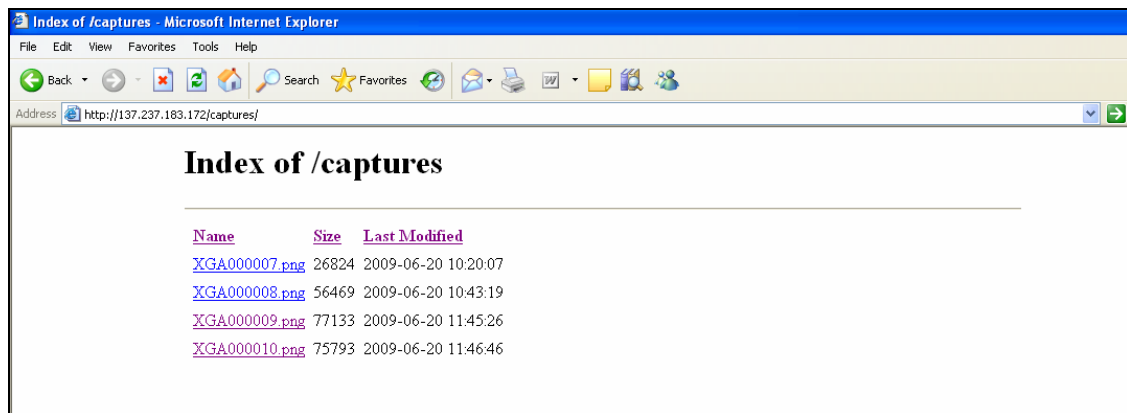

This page is intentionally blank.

Section 8 ♦ Troubleshooting



WARNING: These instructions are for use by qualified personnel only. To reduce the risk of electric shock, do not perform this installation or any servicing unless you are qualified to do so. Refer all servicing to qualified service personnel.

NOTE: When power is applied to the unit, the display shows the startup screen for about 45 seconds.

Initial Checks

If the CMN-41 is not functioning properly, first verify the following:

- The CMN-41 is connected to a power source (11-17 VDC).
- All cables are correctly connected (see “Installation” on page 7).

Initial difficulties with operation or display can be due to improper setup. Review the Setup menus (see “Global Setup Menu Functions” on page 63) to ensure that the proper adjustments have been made for the signal requirements.

Restarting a Unit

If a problem persists after the cables are correctly connected and the unit is set up, restart the unit by doing the following:

1. Push and hold the SETUP button, UP/DOWN knob, and LEFT/RIGHT knob for a minimum of five seconds until the SYSTEM RESET message appears on the display.
2. Press and hold the ENT button to reset the unit’s configuration. All front panel and Setup menu selections will be reset to the factory default settings.
3. Press and hold the PRST button to restart the unit. Unit will reboot. All front panel and Setup menu selections will be reset to the factory default settings.

Problems, Causes, and Solutions

Table 8-1. CMN-41: Problems, Causes, and Solutions

Problem/Symptom	Possible Cause	Solution or Explanation
Unit does not turn on when power button is pressed.	No AC power is present.	Connect the AC power.
No display on external XGA monitor	The monitor is not plugged in or powered up.	Check to see that the monitor is plugged in and powered up.
Display on External XGA monitor is not centered	The XGA monitor is not correctly adjusted.	Use the monitor controls to center the display.

Table 8-1. CMN-41: Problems, Causes, and Solutions

Problem/Symptom	Possible Cause	Solution or Explanation
Waveform not locked when External Reference (Ref:EXT) is selected	The video signal is too low in amplitude or the sync edge is too noisy.	Verify that the External Reference signal is of sufficient amplitude.
	EXT REF is selected but there is no reference input, or the External Reference is non-synchronous.	Select Internal Reference (INT REF) and/or verify that the External Reference signal is synchronous.
No sound on headphone output	The headphone volume is set too low or the output is set to "Mute" in the Audio Mapping Matrix.	Adjust the headphone volume or select the proper channel to be monitored in the Audio Mapping Matrix.
Audio level reading too low	The input reference level is not correctly set.	Use the SETUP MENU to check the input reference level setting.
Picture width not correct	The aspect ratio is not set correctly.	Change aspect ratio in the setup menu.
No communications on Ethernet port	The IP address is incorrect.	Provide the correct IP address in setup menu.
	Incorrect Ethernet cable	For a direct connection, use a crossover cable. For a network connection, use a standard Ethernet cable.

If the problem still exists after troubleshooting the CMN-41, see "Service and Support" on page 6 for further instructions.

Appendix A ♦ Specifications

Specifications are subject to change without notice.

3 Gb/s-SDI Input Specifications

Item	Specification
Input type	2 active looping inputs
Input connector type	BNC female
Input impedance	75Ω nominal
Signal source amplitude	800 mV nominal
Signal source DC offset	±0.5 V
Input return loss	≤ -10 dB, 1.485 GHz – 2.97 GHz
Cable EQ	≥80 M Belden 1694A

HD-SDI Input Specifications

Item	Specification
Input type	2 active looping inputs
Input connector type	BNC female
Input impedance	75Ω nominal
Signal source amplitude	800 mV nominal
Signal source DC offset	±0.5 V
Input return loss	≤ -15 dB 270 MHz-1.485 GHz
Cable EQ	≥100 M Belden 8281

SD-SDI Input Specifications

Item	Specification
Input type	2 active looping inputs
Input connector type	BNC female
Input impedance	75Ω nominal
Signal source amplitude	800 mV nominal
Signal source DC offset	±0.5 V
Input return loss	≤ -25 dB 5 MHz-270 MHz
Cable EQ	≥300 M Belden 8281

External Reference Input Specifications

Item	Specification
Input connector type	BNC female
Input type	1 input, passive looping
Input impedance	75Ω nominal
Blackburst input amplitude (External reference) NTSC PAL	Sync and burst 286 mV nominal Sync and burst 300 mV nominal
Blackburst input amplitude tolerance	±6 dB
Tri-level sync amplitude	600 mV p-p
Tri-level sync amplitude tolerance	± 3 dB
Return loss	≤ -40 dB 100 kHz to 5 MHz

Digital Audio Input Specifications

Item	Specification
Audio formats	AES/EBU, embedded audio
AES input connector type	1 BNC female
AES input impedance	75Ω nominal
AES input return loss	≥ 25dB, 0.1MHz to 6MHz (Unbalanced)
AES input level	0.2 to 2.0 V
AES input sample rate NOTE: Audio inputs are sample rate converted to 48 kHz.	<ul style="list-style-type: none"> • 32 kHz • 44.1 kHz • 48 kHz • 88.2 kHz • 96 kHz
Meter accuracy over frequency	±0.1 dB from 20 Hz to 19 kHz with 0 to -40 dBFS sine wave input, except for within 7 Hz of some submultiples of the 240 kHz oversampling frequency.

3 Gb/s-SDI, HD-SDI, SD-SDI, Output Specifications

Item	Specification
Output impedance	75Ω
Output return loss	≤ -15 dB, 5 MHz to 1.485 GHz
Output return loss	≤ -10 dB, 1.485 GHz to 3 GHz
Output signal level	800 mV ±10%
Output DC offset	0.0 V ± 0.5 V

DVI Output Specifications

Item	Specification
Output connector	DVI-I connector supporting DVI-D
Output resolution	1024×768 (XGA)
Digital levels	Per DDWG DVI rev 1
Pixel rate	65 Mp/s
Display accuracy	<ul style="list-style-type: none"> • ± 1% waveform • ± 1° vector • ± 37 ns timing digital

Analog Monitoring Output Specifications (Headphone)

Item	Specification
Number / connector	One stereo output, one 3.5mm (1/8-in.) headphone jack
Load impedance	16Ω nominal
Maximum output level	44 mW RMS
Total harmonic distortion + noise (THD+N)	≤ -65 dB

Control Specifications

Item	Specification
GPI	Four total with two input and two preset recall selections or individually user configured as alarm input
GPO	One alarm, user configured
Connector	15-pin HD (high density) D-sub, female
Input impedance	10 kΩ returned to +3.3 VDC
Alarm output	Relay closure
Maximum relay current	100 mA @ 50 VDC
Peripheral interface	USB 2.0 supporting storage devices, and keyboard
Connector	USB 2.0, Type A, female

Display Specifications

Item	Specification
General	A full-screen display for viewing an input as picture, waveform, vector, audio, alarm status, or timing
Waveform	Composite; YCbCr or RGB, parade/overlay of like formats
Sweep time base	<ul style="list-style-type: none"> • 1H or 2H with x1, x5, and x10 horizontal magnification • 1V or 2V with x1, x5, and x25 horizontal magnification
Waveform accuracy	≤ ±0.5%
Vector	CB vs. CR for HD or SD
Vector accuracy	≤ 1°
Gamut	Encoded or RGB gamut displays with upper and lower limit selection
Audio	2, 4, 6, 8, or 16 channels displayed simultaneously

Waveform Display Characteristics – External Reference and LTC

Item	Specification
Waveform Amplitude Accuracy	±5%
Waveform Frequency Response	25 Hz to 4.5MHz within ±5% of amplitude at 50 kHz

Time Code Specifications

Item	Specification
Input	<ul style="list-style-type: none"> • LTC via back panel connector • Ancillary Time Code (HD only) • DVITC extracted from SD inputs
Display	Displayed directly

SDI Freeze

Item	Specification
Freeze-capable displays	<ul style="list-style-type: none"> • Waveform • Vector • Picture
Waveform and vector frozen displays	<ul style="list-style-type: none"> • Display frozen • Display live
Picture displays	<ul style="list-style-type: none"> • Display frozen • Display live
Frozen waveform control	<p>The following can be altered on a frozen waveform:</p> <ul style="list-style-type: none"> • Field select (odd or even) • H Mag • V Mag • H pos • V pos • All sweep and filter settings

Gamut Display

Item	Specification
Monitored parameters	<ul style="list-style-type: none"> • Composite gamut (positive and negative chroma packet excursions about luma levels) • RGB gamut
Display type	<ul style="list-style-type: none"> • Polar; Angle of display always represents hue (as in a vectorscope) • Composite display amplitude plots luma plus half of saturation and luma minus half of saturation, with magnitude in IRE or units; concentric circles represent minimum and maximum ranges • Component display plots R, G, and B amplitudes, with magnitude in mV; concentric circles represent minimum and maximum ranges

Magnification

Item	Specification
Waveform sweep gain selection	x1, x5, and x10; pressing the horizontal knob will cycle through x1, x5, and x10 horizontal magnification
Waveform step gain selection	x0.5, x1.0, x2.5, and x5.0; pressing the vertical knob will cycle through x0.5, x1.0, x2.5, and x5.0 vertical magnification
Waveform gain	Variable from x0.50 to x15.00 in 0.01 steps
Vector gain	Variable: x0.50 to x15.00 in 0.01 steps

Communication Interfaces

Item	Specification
Ethernet	1 Ethernet port RJ-45 10/100 Base-T connector
USB	1 USB 2.0 host port
LTC/GPIO	1 LTC/GPIO connector 15 female pin D-sub

Ethernet

Item	Specification
Standard	10/100 Base-T conforms to IEEE802.3
Connector	RJ-45
Performance metric	Transfer a captured frame to a PC in ≤ 30 seconds, dedicated LAN

Power Requirements

Item	Specification
Power connector	15 VDC nominal 11 VDC minimum, 17 VDC maximum
Power consumption	20 W nominal
Over-voltage protection	± 50 VDC nominal

Mechanical

Item	Specification
Dimensions	<ul style="list-style-type: none"> • Height: 1.75 in. (4.45 cm) • Width: 8.5 in. (21.59 cm) • Depth: 6.98 in. (17.73 cm)
Weight	1.9 lb (0.862 kg)

Environmental

Item	Specification
Operating temperature	0° to +45°C
Storage temperature	-30° to +65°C
Humidity (non-condensing)	<ul style="list-style-type: none"> • Operating: 20% to 80% • Non-operating: 5% to 90%
Transportation	24 in. (9.5 cm) impact-drop survivable in original factory packaging

Standard Accessories

Item	Specification
Standard accessories	<ul style="list-style-type: none"> • <i>CMN-41 Installation and Operation Handbook</i> on CD • Breakout connector for LTC/GPI • One power cord • One power supply assembly

Options

Item	Specification
TVM-WRTY2	Full extended warranty plan: Adds three years to the standard two-year warranty
CMN-41	Supports SD-SDI and HD-SDI video
CMN-41-S	Supports SD-SDI video
CMN-41-3GB	Supports SD-SDI, HD-SDI, and 3Gb/s-SDI video
CMN-S2H-F	Field upgrade for CMN-41-S to support HD-SDI video
CMN-S23GB-F	Field upgrade for CMN-41-S to support HD-SDI and 3Gb/s-SDI video
CMN-H23G-F	Field upgrade for CMN-41 to support 3Gb/s-SDI
DRT-4	Double rack mount case
BLK-4	Blank panel for DRT-4

Appendix B ♦ Pinouts

Figure B-1. DVI-D Out Connector

NOTE: This DVI-D connector is only compatible with digital monitors. Analog outputs are not used.

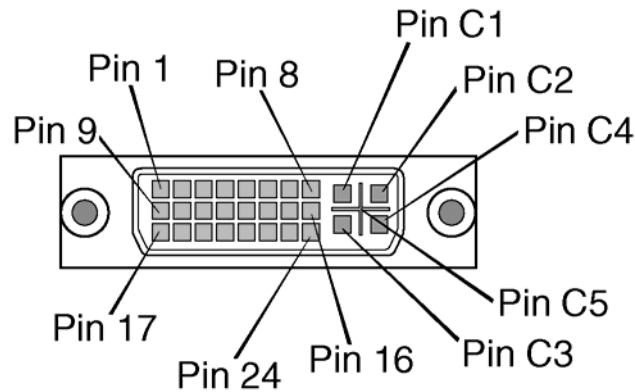

Table B-1. Pinouts for DVI-D Out Connector

Pinout	Signal
1	TMDS data 2-
2	TMDS data 2+
3	TMDS data 2/4 shield
4	TMDS data 4-
5	TMDS data 4+
6	DDC clock
7	DDC data
8	Not used
9	TMDS data 1-
10	TMDS data 1+
11	TMDS data 1/3 shield
12	TMDS data 3-
13	TMDS data 3+
14	+5v power
15	Ground (return for +5v, hsync, and vsync)

Pinout	Signal
16	Hot plug detect
17	TMDS data 0-
18	TMDS data 0+
19	TMDS data 0/5 shield
20	TMDS data 5-
21	TMDS data 5+
22	TMDS clock shield
23	TMDS clock+
24	TMDS clock-
C1	Not used
C2	Not used
C3	Not used
C4	Not used
C5	Not used

Figure B-2. LTC/GPI 15-Pin, Female, D-Sub Connector

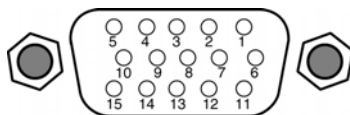

Table B-2. Pinouts for LTC/GPI Connector

Pinout	Signal	Pinout	Signal
1	ERROR SUM	9	LTC GND
2	GPI IN 1	10	LTC+
3	GPI IN 2	11	LTC-
4	GPI IN 3	12	N/C
5	GPI IN 4	13	GND
6	ERROR SUM RETURN	14	N/C
7	GND	15	GND
8	GND		

Figure B-3. Ethernet RJ-45 Connector

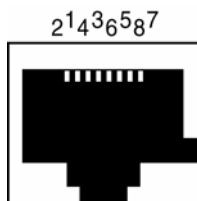

Table B-3. Ethernet RJ-45 Connector Pinouts

Pinout	Signal	Pinout	Signal
1	TX+	5	N.C.
2	TX-	6	RX-
3	RX+	7	N.C.
4	N.C.	8	N.C.

Figure B-4. USB Connector

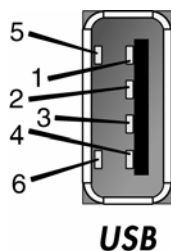

Table B-4. USB Connector Pinouts

Pinout	Signal	Pinout	Signal
1	VCC	4	GND
2	Data -	5	GND
3	Data +	6	GND

Figure B-5. Power Connector

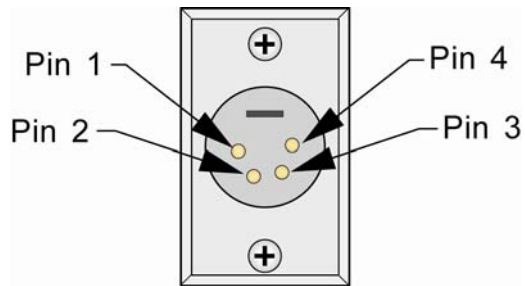

Table B-5. Power Connector Pinouts

Pinout	Signal	Pinout	Signal
1	GND	3	N.C.
2	N.C.	4	Power

This page is intentionally blank.

Appendix C ♦ Open Source Software Copyright Information

Copyright information for certain Open Source software products is provided below. Source code for all Open Source software used in the development of this product is available upon request (contact the Harris Customer Service Department). See “Service and Support” on page 6 for contact information.

FreeType License

Portions of this software are copyright © 2008 The FreeType Project (www.freetype.org). All rights reserved.

LibJPEG License

This software is based in part on the work of the Independent JPEG Group.

CMU/UCD Copyright Notice

Copyright © 1989, 1991, 1992 by Carnegie Mellon University.

Derivative Work - 1996, 1998-2000.

Copyright © 1996, 1998-2000, The Regents of the University of California. All rights reserved.

Permission to use, copy, modify and distribute this software and its documentation for any purpose and without fee is hereby granted, provided that the above copyright notice appears in all copies and that both that copyright notice and this permission notice appear in supporting documentation, and that the name of CMU and The Regents of the University of California not be used in advertising or publicity pertaining to distribution of the software without specific written permission.

CMU AND THE REGENTS OF THE UNIVERSITY OF CALIFORNIA DISCLAIM ALL WARRANTIES WITH REGARD TO THIS SOFTWARE, INCLUDING ALL IMPLIED WARRANTIES OF MERCHANTABILITY AND FITNESS.. IN NO EVENT SHALL CMU OR THE REGENTS OF THE UNIVERSITY OF CALIFORNIA BE LIABLE FOR ANY SPECIAL, INDIRECT OR CONSEQUENTIAL DAMAGES OR ANY DAMAGES WHATSOEVER RESULTING FROM THE LOSS OF USE, DATA OR PROFITS, WHETHER IN AN ACTION OF CONTRACT, NEGLIGENCE OR OTHER TORTIOUS ACTION, ARISING OUT OF OR IN CONNECTION WITH THE USE OR PERFORMANCE OF THIS SOFTWARE..

Networks Associates Technology, Inc. Copyright Notice (BSD)

Copyright © 2001-2003, Networks Associates Technology, Inc. All rights reserved.

Redistribution and use in source and binary forms, with or without modification, are permitted provided that the following conditions are met:

- Redistributions of source code must retain the above copyright notice, this list of conditions and the following disclaimer.
- Redistributions in binary form must reproduce the above copyright notice, this list of conditions and the following disclaimer in the documentation and/or other materials provided with the distribution.
- Neither the name of the Networks Associates Technology, Inc. nor the names of its contributors may be used to endorse or promote products derived from this software without specific prior written permission.

THIS SOFTWARE IS PROVIDED BY THE COPYRIGHT HOLDERS AND CONTRIBUTORS “AS IS” AND ANY EXPRESS OR IMPLIED WARRANTIES, INCLUDING, BUT NOT LIMITED TO, THE IMPLIED WARRANTIES OF MERCHANTABILITY AND FITNESS FOR A PARTICULAR PURPOSE ARE DISCLAIMED. IN NO EVENT SHALL THE COPYRIGHT HOLDERS OR CONTRIBUTORS BE LIABLE FOR ANY DIRECT, INDIRECT, INCIDENTAL, SPECIAL, EXEMPLARY, OR CONSEQUENTIAL DAMAGES (INCLUDING, BUT NOT LIMITED TO, PROCUREMENT OF SUBSTITUTE GOODS OR SERVICES; LOSS OF USE, DATA, OR PROFITS; OR BUSINESS INTERRUPTION) HOWEVER CAUSED AND ON ANY THEORY OF LIABILITY, WHETHER IN CONTRACT, STRICT LIABILITY, OR TORT (INCLUDING NEGLIGENCE OR OTHERWISE) ARISING IN ANY WAY OUT OF THE USE OF THIS SOFTWARE, EVEN IF ADVISED OF THE POSSIBILITY OF SUCH DAMAGE.

Cambridge Broadband Ltd. Copyright Notice (BSD)

Portions of this code are copyright © 2001-2003, Cambridge Broadband Ltd. All rights reserved.

Redistribution and use in source and binary forms, with or without modification, are permitted provided that the following conditions are met:

- Redistributions of source code must retain the above copyright notice, this list of conditions and the following disclaimer.
- Redistributions in binary form must reproduce the above copyright notice, this list of conditions and the following disclaimer in the documentation and/or other materials provided with the distribution.
- The name of Cambridge Broadband Ltd. may not be used to endorse or promote products derived from this software without specific prior written permission.

THIS SOFTWARE IS PROVIDED BY THE COPYRIGHT HOLDER “AS IS” AND ANY EXPRESS OR IMPLIED WARRANTIES, INCLUDING, BUT NOT LIMITED TO, THE IMPLIED WARRANTIES OF MERCHANTABILITY AND FITNESS FOR A PARTICULAR PURPOSE ARE DISCLAIMED. IN NO EVENT SHALL THE COPYRIGHT HOLDER BE LIABLE FOR ANY DIRECT, INDIRECT, INCIDENTAL, SPECIAL, EXEMPLARY, OR CONSEQUENTIAL DAMAGES (INCLUDING, BUT NOT LIMITED TO, PROCUREMENT OF SUBSTITUTE GOODS OR SERVICES; LOSS OF USE, DATA, OR PROFITS; OR BUSINESS INTERRUPTION) HOWEVER CAUSED AND ON ANY THEORY OF LIABILITY, WHETHER IN CONTRACT, STRICT LIABILITY, OR TORT (INCLUDING NEGLIGENCE OR OTHERWISE) ARISING IN ANY WAY OUT OF THE USE OF THIS SOFTWARE, EVEN IF ADVISED OF THE POSSIBILITY OF SUCH DAMAGE.

Sun Microsystems, Inc. Copyright Notice (BSD)

Copyright © 2003 Sun Microsystems, Inc., 4150 Network Circle, Santa Clara, California 95054, U.S.A. All rights reserved.

Use is subject to license terms below.

This distribution may include materials developed by third parties.

Sun, Sun Microsystems, the Sun logo and Solaris are trademarks or registered trademarks of Sun Microsystems, Inc. in the U.S. and other countries.

Redistribution and use in source and binary forms, with or without modification, are permitted provided that the following conditions are met:

- Redistributions of source code must retain the above copyright notice, this list of conditions and the following disclaimer.
- Redistributions in binary form must reproduce the above copyright notice, this list of conditions and the following disclaimer in the documentation and/or other materials provided with the distribution.
- Neither the name of the Sun Microsystems, Inc. nor the names of its contributors may be used to endorse or promote products derived from this software without specific prior written permission.

THIS SOFTWARE IS PROVIDED BY THE COPYRIGHT HOLDERS AND CONTRIBUTORS "AS IS" AND ANY EXPRESS OR IMPLIED WARRANTIES, INCLUDING, BUT NOT LIMITED TO, THE IMPLIED WARRANTIES OF MERCHANTABILITY AND FITNESS FOR A PARTICULAR PURPOSE ARE DISCLAIMED. IN NO EVENT SHALL THE COPYRIGHT HOLDERS OR CONTRIBUTORS BE LIABLE FOR ANY DIRECT, INDIRECT, INCIDENTAL, SPECIAL, EXEMPLARY, OR CONSEQUENTIAL DAMAGES (INCLUDING, BUT NOT LIMITED TO, PROCUREMENT OF SUBSTITUTE GOODS OR SERVICES; LOSS OF USE, DATA, OR PROFITS; OR BUSINESS INTERRUPTION) HOWEVER CAUSED AND ON ANY THEORY OF LIABILITY, WHETHER IN CONTRACT, STRICT LIABILITY, OR TORT (INCLUDING NEGLIGENCE OR OTHERWISE) ARISING IN ANY WAY OUT OF THE USE OF THIS SOFTWARE, EVEN IF ADVISED OF THE POSSIBILITY OF SUCH DAMAGE.

Sparta, Inc. Copyright Notice (BSD)

Copyright © 2003-2008, Sparta, Inc. All rights reserved.

Redistribution and use in source and binary forms, with or without modification, are permitted provided that the following conditions are met:

- Redistributions of source code must retain the above copyright notice, this list of conditions and the following disclaimer.
- Redistributions in binary form must reproduce the above copyright notice, this list of conditions and the following disclaimer in the documentation and/or other materials provided with the distribution.
- Neither the name of Sparta, Inc. nor the names of its contributors may be used to endorse or promote products derived from this software without specific prior written permission.

THIS SOFTWARE IS PROVIDED BY THE COPYRIGHT HOLDERS AND CONTRIBUTORS “AS IS” AND ANY EXPRESS OR IMPLIED WARRANTIES, INCLUDING, BUT NOT LIMITED TO, THE IMPLIED WARRANTIES OF MERCHANTABILITY AND FITNESS FOR A PARTICULAR PURPOSE ARE DISCLAIMED.. IN NO EVENT SHALL THE COPYRIGHT HOLDERS OR CONTRIBUTORS BE LIABLE FOR ANY DIRECT, INDIRECT, INCIDENTAL, SPECIAL, EXEMPLARY, OR CONSEQUENTIAL DAMAGES (INCLUDING, BUT NOT LIMITED TO, PROCUREMENT OF SUBSTITUTE GOODS OR SERVICES; LOSS OF USE, DATA, OR PROFITS; OR BUSINESS INTERRUPTION) HOWEVER CAUSED AND ON ANY THEORY OF LIABILITY, WHETHER IN CONTRACT, STRICT LIABILITY, OR TORT (INCLUDING NEGLIGENCE OR OTHERWISE) ARISING IN ANY WAY OUT OF THE USE OF THIS SOFTWARE, EVEN IF ADVISED OF THE POSSIBILITY OF SUCH DAMAGE.

Cisco/BUPTNIC Copyright Notice (BSD)

Copyright © 2004, Cisco, Inc and Information Network Center of Beijing University of Posts and Telecommunications. All rights reserved.

Redistribution and use in source and binary forms, with or without modification, are permitted provided that the following conditions are met:

- Redistributions of source code must retain the above copyright notice, this list of conditions and the following disclaimer.
- Redistributions in binary form must reproduce the above copyright notice, this list of conditions and the following disclaimer in the documentation and/or other materials provided with the distribution.
- Neither the name of Cisco, Inc, Beijing University of Posts and . . Telecommunications, nor the names of their contributors may. . be used to endorse or promote products derived from this software. . without specific prior written permission.

THIS SOFTWARE IS PROVIDED BY THE COPYRIGHT HOLDERS AND CONTRIBUTORS "AS IS" AND ANY EXPRESS OR IMPLIED WARRANTIES, INCLUDING, BUT NOT LIMITED TO, THE IMPLIED WARRANTIES OF MERCHANTABILITY AND FITNESS FOR A PARTICULAR PURPOSE ARE DISCLAIMED. IN NO EVENT SHALL THE COPYRIGHT HOLDERS OR CONTRIBUTORS BE LIABLE FOR ANY DIRECT, INDIRECT, INCIDENTAL, SPECIAL, EXEMPLARY, OR CONSEQUENTIAL DAMAGES (INCLUDING, BUT NOT LIMITED TO, PROCUREMENT OF SUBSTITUTE GOODS OR SERVICES; LOSS OF USE, DATA, OR PROFITS; OR BUSINESS INTERRUPTION) HOWEVER CAUSED AND ON ANY THEORY OF LIABILITY, WHETHER IN CONTRACT, STRICT LIABILITY, OR TORT (INCLUDING NEGLIGENCE OR OTHERWISE) ARISING IN ANY WAY OUT OF THE USE OF THIS SOFTWARE, EVEN IF ADVISED OF THE POSSIBILITY OF SUCH DAMAGE.

Fabasoft R&D Software GmbH & Co. KG Copyright Notice (BSD)

Copyright © Fabasoft R&D Software GmbH & Co. KG, 2003 oss@fabasoft.com.
Author: Bernhard Penz

Redistribution and use in source and binary forms, with or without modification, are permitted provided that the following conditions are met:

- Redistributions of source code must retain the above copyright notice, this list of conditions and the following disclaimer.
- Redistributions in binary form must reproduce the above copyright notice, this list of conditions and the following disclaimer in the documentation and/or other materials provided with the distribution.
- The name of Fabasoft R&D Software GmbH & Co KG or any of its subsidiaries, brand or product names may not be used to endorse or promote products derived from this software without specific prior written permission.

THIS SOFTWARE IS PROVIDED BY THE COPYRIGHT HOLDER "AS IS" AND ANY EXPRESS OR IMPLIED WARRANTIES, INCLUDING, BUT NOT LIMITED TO, THE IMPLIED WARRANTIES OF MERCHANTABILITY AND FITNESS FOR A PARTICULAR PURPOSE ARE DISCLAIMED. IN NO EVENT SHALL THE COPYRIGHT HOLDER BE LIABLE FOR ANY DIRECT, INDIRECT, INCIDENTAL, SPECIAL, EXEMPLARY, OR CONSEQUENTIAL DAMAGES (INCLUDING, BUT NOT LIMITED TO, PROCUREMENT OF SUBSTITUTE GOODS OR SERVICES; LOSS OF USE, DATA, OR PROFITS; OR BUSINESS INTERRUPTION) HOWEVER CAUSED AND ON ANY THEORY OF LIABILITY, WHETHER IN CONTRACT, STRICT LIABILITY, OR TORT (INCLUDING NEGLIGENCE OR OTHERWISE) ARISING IN ANY WAY OUT OF THE USE OF THIS SOFTWARE, EVEN IF ADVISED OF THE POSSIBILITY OF SUCH DAMAGE.

The GNU v2 License

GNU General Public License

Version 2, June 1991

Copyright © 1989, 1991 Free Software Foundation, Inc., 51 Franklin Street, Fifth Floor, Boston, MA 02110-1301 USA. Everyone is permitted to copy and distribute verbatim copies of this license document, but changing it is not allowed.

Preamble

The licenses for most software are designed to take away your freedom to share and change it. By contrast, the GNU General Public License is intended to guarantee your freedom to share and change free software--to make sure the software is free for all its users. This General Public License applies to most of the Free Software Foundation's software and to any other program whose authors commit to using it. (Some other Free Software Foundation software is covered by the GNU Lesser General Public License instead.) You can apply it to your programs, too.

When we speak of free software, we are referring to freedom, not price. Our General Public Licenses are designed to make sure that you have the freedom to distribute copies of free software (and charge for this service if you wish), that you receive source code or can get it if you want it, that you can change the software or use pieces of it in new free programs; and that you know you can do these things.

To protect your rights, we need to make restrictions that forbid anyone to deny you these rights or to ask you to surrender the rights. These restrictions translate to certain responsibilities for you if you distribute copies of the software, or if you modify it.

For example, if you distribute copies of such a program, whether gratis or for a fee, you must give the recipients all the rights that you have. You must make sure that they, too, receive or can get the source code. And you must show them these terms so they know their rights.

We protect your rights with two steps: (1) copyright the software, and (2) offer you this license which gives you legal permission to copy, distribute and/or modify the software.

Also, for each author's protection and ours, we want to make certain that everyone understands that there is no warranty for this free software. If the software is modified by someone else and passed on, we want its recipients to know that what they have is not the original, so that any problems introduced by others will not reflect on the original authors' reputations.

Finally, any free program is threatened constantly by software patents. We wish to avoid the danger that redistributors of a free program will individually obtain patent licenses, in effect making the program proprietary. To prevent this, we have made it clear that any patent must be licensed for everyone's free use or not licensed at all.

The precise terms and conditions for copying, distribution and modification follow.

GNU General Public License

Terms and Conditions for Copying, Distribution and Modification

0. This License applies to any program or other work which contains a notice placed by the copyright holder saying it may be distributed under the terms of this General Public License. The “Program,” below, refers to any such program or work, and a “work based on the Program” means either the Program or any derivative work under copyright law: that is to say, a work containing the Program or a portion of it, either verbatim or with modifications and/or translated into another language. (Hereinafter, translation is included without limitation in the term “modification.”) Each licensee is addressed as “you.”

Activities other than copying, distribution and modification are not covered by this License; they are outside its scope. The act of running the Program is not restricted, and the output from the Program is covered only if its contents constitute a work based on the Program (independent of having been made by running the Program). Whether that is true depends on what the Program does.

1. You may copy and distribute verbatim copies of the Program's source code as you receive it, in any medium, provided that you conspicuously and appropriately publish on each copy an appropriate copyright notice and disclaimer of warranty; keep intact all the notices that refer to this License and to the absence of any warranty; and give any other recipients of the Program a copy of this License along with the Program.

You may charge a fee for the physical act of transferring a copy, and you may at your option offer warranty protection in exchange for a fee.

2. You may modify your copy or copies of the Program or any portion of it, thus forming a work based on the Program, and copy and distribute such modifications or work under the terms of Section 1 above, provided that you also meet all of these conditions:

- a) You must cause the modified files to carry prominent notices stating that you changed the files and the date of any change.
- b) You must cause any work that you distribute or publish, that in whole or in part contains or is derived from the Program or any part thereof, to be licensed as a whole at no charge to all third parties under the terms of this License.
- c) If the modified program normally reads commands interactively when run, you must cause it, when started running for such interactive use in the most ordinary way, to print or display an announcement including an appropriate copyright notice and a notice that there is no warranty (or else, saying that you provide a warranty) and that users may redistribute the program under these conditions, and telling the user how to view a copy of this License. (Exception: if the Program itself is interactive but does not normally print such an announcement, your work based on the Program is not required to print an announcement.)

These requirements apply to the modified work as a whole. If identifiable sections of that work are not derived from the Program, and can be reasonably considered independent and separate works in themselves, then this License, and its terms, do not apply to those sections when you distribute them as separate works. But when you distribute the same sections as part of a whole which is a work based on the Program,

the distribution of the whole must be on the terms of this License, whose permissions for other licensees extend to the entire whole, and thus to each and every part regardless of who wrote it.

Thus, it is not the intent of this section to claim rights or contest your rights to work written entirely by you; rather, the intent is to exercise the right to control the distribution of derivative or collective works based on the Program.

In addition, mere aggregation of another work not based on the Program with the Program (or with a work based on the Program) on a volume of a storage or distribution medium does not bring the other work under the scope of this License.

3. You may copy and distribute the Program (or a work based on it, under Section 2) in object code or executable form under the terms of Sections 1 and 2 above provided that you also do one of the following:

- a) Accompany it with the complete corresponding machine-readable source code, which must be distributed under the terms of Sections 1 and 2 above on a medium customarily used for software interchange; or,
- b) Accompany it with a written offer, valid for at least three years, to give any third party, for a charge no more than your cost of physically performing source distribution, a complete machine-readable copy of the corresponding source code, to be distributed under the terms of Sections 1 and 2 above on a medium customarily used for software interchange; or,
- c) Accompany it with the information you received as to the offer to distribute corresponding source code. (This alternative is allowed only for noncommercial distribution and only if you received the program in object code or executable form with such an offer, in accord with Subsection b above.)

The source code for a work means the preferred form of the work for making modifications to it. For an executable work, complete source code means all the source code for all modules it contains, plus any associated interface definition files, plus the scripts used to control compilation and installation of the executable. However, as a special exception, the source code distributed need not include anything that is normally distributed (in either source or binary form) with the major components (compiler, kernel, and so on) of the operating system on which the executable runs, unless that component itself accompanies the executable.

If distribution of executable or object code is made by offering access to copy from a designated place, then offering equivalent access to copy the source code from the same place counts as distribution of the source code, even though third parties are not compelled to copy the source along with the object code.

4. You may not copy, modify, sublicense, or distribute the Program except as expressly provided under this License. Any attempt otherwise to copy, modify, sublicense or distribute the Program is void, and will automatically terminate your rights under this License. However, parties who have received copies, or rights, from you under this License will not have their licenses terminated so long as such parties remain in full compliance.

5. You are not required to accept this License, since you have not signed it. However, nothing else grants you permission to modify or distribute the Program or its derivative

works. These actions are prohibited by law if you do not accept this License. Therefore, by modifying or distributing the Program (or any work based on the Program), you indicate your acceptance of this License to do so, and all its terms and conditions for copying, distributing or modifying the Program or works based on it.

6. Each time you redistribute the Program (or any work based on the Program), the recipient automatically receives a license from the original licensor to copy, distribute or modify the Program subject to these terms and conditions. You may not impose any further restrictions on the recipients' exercise of the rights granted herein. You are not responsible for enforcing compliance by third parties to this License.

7. If, as a consequence of a court judgment or allegation of patent infringement or for any other reason (not limited to patent issues), conditions are imposed on you (whether by court order, agreement or otherwise) that contradict the conditions of this License, they do not excuse you from the conditions of this License. If you cannot distribute so as to satisfy simultaneously your obligations under this License and any other pertinent obligations, then as a consequence you may not distribute the Program at all. For example, if a patent license would not permit royalty-free redistribution of the Program by all those who receive copies directly or indirectly through you, then the only way you could satisfy both it and this License would be to refrain entirely from distribution of the Program.

If any portion of this section is held invalid or unenforceable under any particular circumstance, the balance of the section is intended to apply and the section as a whole is intended to apply in other circumstances.

It is not the purpose of this section to induce you to infringe any patents or other property right claims or to contest validity of any such claims; this section has the sole purpose of protecting the integrity of the free software distribution system, which is implemented by public license practices. Many people have made generous contributions to the wide range of software distributed through that system in reliance on consistent application of that system; it is up to the author/donor to decide if he or she is willing to distribute software through any other system and a licensee cannot impose that choice.

This section is intended to make thoroughly clear what is believed to be a consequence of the rest of this License.

8. If the distribution and/or use of the Program is restricted in certain countries either by patents or by copyrighted interfaces, the original copyright holder who places the Program under this License may add an explicit geographical distribution limitation excluding those countries, so that distribution is permitted only in or among countries not thus excluded. In such case, this License incorporates the limitation as if written in the body of this License.

9. The Free Software Foundation may publish revised and/or new versions of the General Public License from time to time. Such new versions will be similar in spirit to the present version, but may differ in detail to address new problems or concerns.

Each version is given a distinguishing version number. If the Program specifies a version number of this License which applies to it and "any later version," you have the option of following the terms and conditions either of that version or of any later version published by the Free Software Foundation. If the Program does not specify a

version number of this License, you may choose any version ever published by the Free Software Foundation.

10. If you wish to incorporate parts of the Program into other free programs whose distribution conditions are different, write to the author to ask for permission. For software which is copyrighted by the Free Software Foundation, write to the Free Software Foundation; we sometimes make exceptions for this. Our decision will be guided by the two goals of preserving the free status of all derivatives of our free software and of promoting the sharing and reuse of software generally.

No Warranty

11. BECAUSE THE PROGRAM IS LICENSED FREE OF CHARGE, THERE IS NO WARRANTY FOR THE PROGRAM, TO THE EXTENT PERMITTED BY APPLICABLE LAW. EXCEPT WHEN OTHERWISE STATED IN WRITING THE COPYRIGHT HOLDERS AND/OR OTHER PARTIES PROVIDE THE PROGRAM "AS IS" WITHOUT WARRANTY OF ANY KIND, EITHER EXPRESSED OR IMPLIED, INCLUDING, BUT NOT LIMITED TO, THE IMPLIED WARRANTIES OF MERCHANTABILITY AND FITNESS FOR A PARTICULAR PURPOSE. THE ENTIRE RISK AS TO THE QUALITY AND PERFORMANCE OF THE PROGRAM IS WITH YOU. SHOULD THE PROGRAM PROVE DEFECTIVE, YOU ASSUME THE COST OF ALL NECESSARY SERVICING, REPAIR OR CORRECTION.

12. IN NO EVENT UNLESS REQUIRED BY APPLICABLE LAW OR AGREED TO IN WRITING WILL ANY COPYRIGHT HOLDER, OR ANY OTHER PARTY WHO MAY MODIFY AND/OR REDISTRIBUTE THE PROGRAM AS PERMITTED ABOVE, BE LIABLE TO YOU FOR DAMAGES, INCLUDING ANY GENERAL, SPECIAL, INCIDENTAL OR CONSEQUENTIAL DAMAGES ARISING OUT OF THE USE OR INABILITY TO USE THE PROGRAM (INCLUDING BUT NOT LIMITED TO LOSS OF DATA OR DATA BEING RENDERED INACCURATE OR LOSSES SUSTAINED BY YOU OR THIRD PARTIES OR A FAILURE OF THE PROGRAM TO OPERATE WITH ANY OTHER PROGRAMS), EVEN IF SUCH HOLDER OR OTHER PARTY HAS BEEN ADVISED OF THE POSSIBILITY OF SUCH DAMAGES.

END OF TERMS AND CONDITIONS

GNU Lesser Public License

GNU Lesser General Public License

Version 2.1, February 1999

Copyright © 1991, 1999 Free Software Foundation, Inc., 51 Franklin Street, Fifth Floor, Boston, MA 02110-1301 USA. Everyone is permitted to copy and distribute verbatim copies of this license document, but changing it is not allowed.

[This is the first released version of the Lesser GPL. It also counts as the successor of the GNU Library Public License, version 2, hence the version number 2.1.]

Preamble

The licenses for most software are designed to take away your freedom to share and change it. By contrast, the GNU General Public Licenses are intended to guarantee your freedom to share and change free software--to make sure the software is free for all its users.

This license, the Lesser General Public License, applies to some specially designated software packages--typically libraries--of the Free Software Foundation and other authors who decide to use it. You can use it too, but we suggest you first think carefully about whether this license or the ordinary General Public License is the better strategy to use in any particular case, based on the explanations below.

When we speak of free software, we are referring to freedom of use, not price. Our General Public Licenses are designed to make sure that you have the freedom to distribute copies of free software (and charge for this service if you wish); that you receive source code or can get it if you want it; that you can change the software and use pieces of it in new free programs; and that you are informed that you can do these things.

To protect your rights, we need to make restrictions that forbid distributors to deny you these rights or to ask you to surrender these rights. These restrictions translate to certain responsibilities for you if you distribute copies of the library or if you modify it.

For example, if you distribute copies of the library, whether gratis or for a fee, you must give the recipients all the rights that we gave you. You must make sure that they, too, receive or can get the source code. If you link other code with the library, you must provide complete object files to the recipients, so that they can relink them with the library after making changes to the library and recompiling it. And you must show them these terms so they know their rights.

We protect your rights with a two-step method: (1) we copyright the library, and (2) we offer you this license, which gives you legal permission to copy, distribute and/or modify the library.

To protect each distributor, we want to make it very clear that there is no warranty for the free library. Also, if the library is modified by someone else and passed on, the recipients should know that what they have is not the original version, so that the original author's reputation will not be affected by problems that might be introduced by others.

Finally, software patents pose a constant threat to the existence of any free program. We wish to make sure that a company cannot effectively restrict the users of a free program by obtaining a restrictive license from a patent holder. Therefore, we insist that any patent license obtained for a version of the library must be consistent with the full freedom of use specified in this license.

Most GNU software, including some libraries, is covered by the ordinary GNU General Public License. This license, the GNU Lesser General Public License, applies to certain designated libraries, and is quite different from the ordinary General Public License. We use this license for certain libraries in order to permit linking those libraries into non-free programs.

When a program is linked with a library, whether statically or using a shared library, the combination of the two is legally speaking a combined work, a derivative of the original library. The ordinary General Public License therefore permits such linking only if the entire combination fits its criteria of freedom. The Lesser General Public License permits more lax criteria for linking other code with the library.

We call this license the “Lesser” General Public License because it does Less to protect the user’s freedom than the ordinary General Public License. It also provides other free software developers Less of an advantage over competing non-free programs. These disadvantages are the reason we use the ordinary General Public License for many libraries. However, the Lesser license provides advantages in certain special circumstances.

For example, on rare occasions, there may be a special need to encourage the widest possible use of a certain library, so that it becomes a de-facto standard. To achieve this, non-free programs must be allowed to use the library. A more frequent case is that a free library does the same job as widely used non-free libraries. In this case, there is little to gain by limiting the free library to free software only, so we use the Lesser General Public License.

In other cases, permission to use a particular library in non-free programs enables a greater number of people to use a large body of free software. For example, permission to use the GNU C Library in non-free programs enables many more people to use the whole GNU operating system, as well as its variant, the GNU/Linux operating system.

Although the Lesser General Public License is Less protective of the users’ freedom, it does ensure that the user of a program that is linked with the Library has the freedom and the wherewithal to run that program using a modified version of the Library.

The precise terms and conditions for copying, distribution and modification follow. Pay close attention to the difference between a “work based on the library” and a “work that uses the library.” The former contains code derived from the library, whereas the latter must be combined with the library in order to run.

GNU Lesser General Public License

Terms and Conditions for Copying, Distribution and Modification

0. This License Agreement applies to any software library or other program which contains a notice placed by the copyright holder or other authorized party saying it may be distributed under the terms of this Lesser General Public License (also called “this License”). Each licensee is addressed as “you.”

A “library” means a collection of software functions and/or data prepared so as to be conveniently linked with application programs (which use some of those functions and data) to form executables.

The “Library,” below, refers to any such software library or work which has been distributed under these terms. A “work based on the Library” means either the Library or any derivative work under copyright law: that is to say, a work containing the Library or a portion of it, either verbatim or with modifications and/or translated straightforwardly into another language. (Hereinafter, translation is included without limitation in the term “modification.”)

“Source code” for a work means the preferred form of the work for making modifications to it. For a library, complete source code means all the source code for all modules it contains, plus any associated interface definition files, plus the scripts used to control compilation and installation of the library.

Activities other than copying, distribution and modification are not covered by this License; they are outside its scope. The act of running a program using the Library is not restricted, and output from such a program is covered only if its contents constitute a work based on the Library (independent of the use of the Library in a tool for writing it). Whether that is true depends on what the Library does and what the program that uses the Library does.

1. You may copy and distribute verbatim copies of the Library’s complete source code as you receive it, in any medium, provided that you conspicuously and appropriately publish on each copy an appropriate copyright notice and disclaimer of warranty; keep intact all the notices that refer to this License and to the absence of any warranty; and distribute a copy of this License along with the Library.

You may charge a fee for the physical act of transferring a copy, and you may at your option offer warranty protection in exchange for a fee.

2. You may modify your copy or copies of the Library or any portion of it, thus forming a work based on the Library, and copy and distribute such modifications or work under the terms of Section 1 above, provided that you also meet all of these conditions:

- a) The modified work must itself be a software library.
- b) You must cause the files modified to carry prominent notices stating that you changed the files and the date of any change.
- c) You must cause the whole of the work to be licensed at no charge to all third parties under the terms of this License.

d) If a facility in the modified Library refers to a function or a table of data to be supplied by an application program that uses the facility, other than as an argument passed when the facility is invoked, then you must make a good faith effort to ensure that, in the event an application does not supply such function or table, the facility still operates, and performs whatever part of its purpose remains meaningful.

(For example, a function in a library to compute square roots has a purpose that is entirely well-defined independent of the application. Therefore, Subsection 2d requires that any application-supplied function or table used by this function must be optional: if the application does not supply it, the square root function must still compute square roots.)

These requirements apply to the modified work as a whole. If identifiable sections of that work are not derived from the Library, and can be reasonably considered independent and separate works in themselves, then this License, and its terms, do not apply to those sections when you distribute them as separate works. But when you distribute the same sections as part of a whole which is a work based on the Library, the distribution of the whole must be on the terms of this License, whose permissions for other licensees extend to the entire whole, and thus to each and every part regardless of who wrote it.

Thus, it is not the intent of this section to claim rights or contest your rights to work written entirely by you; rather, the intent is to exercise the right to control the distribution of derivative or collective works based on the Library.

In addition, mere aggregation of another work not based on the Library with the Library (or with a work based on the Library) on a volume of a storage or distribution medium does not bring the other work under the scope of this License.

3. You may opt to apply the terms of the ordinary GNU General Public License instead of this License to a given copy of the Library. To do this, you must alter all the notices that refer to this License, so that they refer to the ordinary GNU General Public License, version 2, instead of to this License. (If a newer version than version 2 of the ordinary GNU General Public License has appeared, then you can specify that version instead if you wish.) Do not make any other change in these notices.

Once this change is made in a given copy, it is irreversible for that copy, so the ordinary GNU General Public License applies to all subsequent copies and derivative works made from that copy.

This option is useful when you wish to copy part of the code of the Library into a program that is not a library.

4. You may copy and distribute the Library (or a portion or derivative of it, under Section 2) in object code or executable form under the terms of Sections 1 and 2 above provided that you accompany it with the complete corresponding machine-readable source code, which must be distributed under the terms of Sections 1 and 2 above on a medium customarily used for software interchange.

If distribution of object code is made by offering access to copy from a designated place, then offering equivalent access to copy the source code from the same place

satisfies the requirement to distribute the source code, even though third parties are not compelled to copy the source along with the object code.

5. A program that contains no derivative of any portion of the Library, but is designed to work with the Library by being compiled or linked with it, is called a “work that uses the Library.” Such a work, in isolation, is not a derivative work of the Library, and therefore falls outside the scope of this License.

However, linking a “work that uses the Library” with the Library creates an executable that is a derivative of the Library (because it contains portions of the Library), rather than a “work that uses the library.” The executable is therefore covered by this License. Section 6 states terms for distribution of such executables.

When a “work that uses the Library” uses material from a header file that is part of the Library, the object code for the work may be a derivative work of the Library even though the source code is not. Whether this is true is especially significant if the work can be linked without the Library, or if the work is itself a library. The threshold for this to be true is not precisely defined by law.

If such an object file uses only numerical parameters, data structure layouts and accessors, and small macros and small inline functions (ten lines or less in length), then the use of the object file is unrestricted, regardless of whether it is legally a derivative work. (Executables containing this object code plus portions of the Library will still fall under Section 6.)

Otherwise, if the work is a derivative of the Library, you may distribute the object code for the work under the terms of Section 6. Any executables containing that work also fall under Section 6, whether or not they are linked directly with the Library itself.

6. As an exception to the Sections above, you may also combine or link a “work that uses the Library” with the Library to produce a work containing portions of the Library, and distribute that work under terms of your choice, provided that the terms permit modification of the work for the customer’s own use and reverse engineering for debugging such modifications.

You must give prominent notice with each copy of the work that the Library is used in it and that the Library and its use are covered by this License. You must supply a copy of this License. If the work during execution displays copyright notices, you must include the copyright notice for the Library among them, as well as a reference directing the user to the copy of this License. Also, you must do one of these things:

- a) Accompany the work with the complete corresponding machine-readable source code for the Library including whatever changes were used in the work (which must be distributed under Sections 1 and 2 above); and, if the work is an executable linked with the Library, with the complete machine-readable “work that uses the Library,” as object code and/or source code, so that the user can modify the Library and then relink to produce a modified executable containing the modified Library. (It is understood that the user who changes the contents of definitions files in the Library will not necessarily be able to recompile the application to use the modified definitions.)
- b) Use a suitable shared library mechanism for linking with the Library. A suitable mechanism is one that (1) uses at run time a copy of the library already present on

the user's computer system, rather than copying library functions into the executable, and (2) will operate properly with a modified version of the library, if the user installs one, as long as the modified version is interface-compatible with the version that the work was made with.

- c) Accompany the work with a written offer, valid for at least three years, to give the same user the materials specified in Subsection 6a, above, for a charge no more than the cost of performing this distribution.
- d) If distribution of the work is made by offering access to copy from a designated place, offer equivalent access to copy the above specified materials from the same place.
- e) Verify that the user has already received a copy of these materials or that you have already sent this user a copy.

For an executable, the required form of the “work that uses the Library” must include any data and utility programs needed for reproducing the executable from it. However, as a special exception, the materials to be distributed need not include anything that is normally distributed (in either source or binary form) with the major components (compiler, kernel, and so on) of the operating system on which the executable runs, unless that component itself accompanies the executable.

It may happen that this requirement contradicts the license restrictions of other proprietary libraries that do not normally accompany the operating system. Such a contradiction means you cannot use both them and the Library together in an executable that you distribute.

7. You may place library facilities that are a work based on the Library side-by-side in a single library together with other library facilities not covered by this License, and distribute such a combined library, provided that the separate distribution of the work based on the Library and of the other library facilities is otherwise permitted, and provided that you do these two things:

- a) Accompany the combined library with a copy of the same work based on the Library, uncombined with any other library facilities. This must be distributed under the terms of the Sections above.
- b) Give prominent notice with the combined library of the fact that part of it is a work based on the Library, and explaining where to find the accompanying uncombined form of the same work.

8. You may not copy, modify, sublicense, link with, or distribute the Library except as expressly provided under this License. Any attempt otherwise to copy, modify, sublicense, link with, or distribute the Library is void, and will automatically terminate your rights under this License. However, parties who have received copies, or rights, from you under this License will not have their licenses terminated so long as such parties remain in full compliance.

9. You are not required to accept this License, since you have not signed it. However, nothing else grants you permission to modify or distribute the Library or its derivative works. These actions are prohibited by law if you do not accept this License. Therefore, by modifying or distributing the Library (or any work based on the Library),

you indicate your acceptance of this License to do so, and all its terms and conditions for copying, distributing or modifying the Library or works based on it.

10. Each time you redistribute the Library (or any work based on the Library), the recipient automatically receives a license from the original licensor to copy, distribute, link with or modify the Library subject to these terms and conditions. You may not impose any further restrictions on the recipients' exercise of the rights granted herein. You are not responsible for enforcing compliance by third parties with this License.

11. If, as a consequence of a court judgment or allegation of patent infringement or for any other reason (not limited to patent issues), conditions are imposed on you (whether by court order, agreement or otherwise) that contradict the conditions of this License, they do not excuse you from the conditions of this License. If you cannot distribute so as to satisfy simultaneously your obligations under this License and any other pertinent obligations, then as a consequence you may not distribute the Library at all. For example, if a patent license would not permit royalty-free redistribution of the Library by all those who receive copies directly or indirectly through you, then the only way you could satisfy both it and this License would be to refrain entirely from distribution of the Library.

If any portion of this section is held invalid or unenforceable under any particular circumstance, the balance of the section is intended to apply, and the section as a whole is intended to apply in other circumstances.

It is not the purpose of this section to induce you to infringe any patents or other property right claims or to contest validity of any such claims; this section has the sole purpose of protecting the integrity of the free software distribution system which is implemented by public license practices. Many people have made generous contributions to the wide range of software distributed through that system in reliance on consistent application of that system; it is up to the author/donor to decide if he or she is willing to distribute software through any other system and a licensee cannot impose that choice.

This section is intended to make thoroughly clear what is believed to be a consequence of the rest of this License.

12. If the distribution and/or use of the Library is restricted in certain countries either by patents or by copyrighted interfaces, the original copyright holder who places the Library under this License may add an explicit geographical distribution limitation excluding those countries, so that distribution is permitted only in or among countries not thus excluded. In such case, this License incorporates the limitation as if written in the body of this License.

13. The Free Software Foundation may publish revised and/or new versions of the Lesser General Public License from time to time. Such new versions will be similar in spirit to the present version, but may differ in detail to address new problems or concerns.

Each version is given a distinguishing version number. If the Library specifies a version number of this License which applies to it and "any later version," you have the option of following the terms and conditions either of that version or of any later version published by the Free Software Foundation. If the Library does not specify a

license version number, you may choose any version ever published by the Free Software Foundation.

14. If you wish to incorporate parts of the Library into other free programs whose distribution conditions are incompatible with these, write to the author to ask for permission. For software which is copyrighted by the Free Software Foundation, write to the Free Software Foundation; we sometimes make exceptions for this. Our decision will be guided by the two goals of preserving the free status of all derivatives of our free software and of promoting the sharing and reuse of software generally.

No Warranty

15. BECAUSE THE LIBRARY IS LICENSED FREE OF CHARGE, THERE IS NO WARRANTY FOR THE LIBRARY, TO THE EXTENT PERMITTED BY APPLICABLE LAW. EXCEPT WHEN OTHERWISE STATED IN WRITING THE COPYRIGHT HOLDERS AND/OR OTHER PARTIES PROVIDE THE LIBRARY “AS IS” WITHOUT WARRANTY OF ANY KIND, EITHER EXPRESSED OR IMPLIED, INCLUDING, BUT NOT LIMITED TO, THE IMPLIED WARRANTIES OF MERCHANTABILITY AND FITNESS FOR A PARTICULAR PURPOSE. THE ENTIRE RISK AS TO THE QUALITY AND PERFORMANCE OF THE LIBRARY IS WITH YOU. SHOULD THE LIBRARY PROVE DEFECTIVE, YOU ASSUME THE COST OF ALL NECESSARY SERVICING, REPAIR OR CORRECTION.

16. IN NO EVENT UNLESS REQUIRED BY APPLICABLE LAW OR AGREED TO IN WRITING WILL ANY COPYRIGHT HOLDER, OR ANY OTHER PARTY WHO MAY MODIFY AND/OR REDISTRIBUTE THE LIBRARY AS PERMITTED ABOVE, BE LIABLE TO YOU FOR DAMAGES, INCLUDING ANY GENERAL, SPECIAL, INCIDENTAL OR CONSEQUENTIAL DAMAGES ARISING OUT OF THE USE OR INABILITY TO USE THE LIBRARY (INCLUDING BUT NOT LIMITED TO LOSS OF DATA OR DATA BEING RENDERED INACCURATE OR LOSSES SUSTAINED BY YOU OR THIRD PARTIES OR A FAILURE OF THE LIBRARY TO OPERATE WITH ANY OTHER SOFTWARE), EVEN IF SUCH HOLDER OR OTHER PARTY HAS BEEN ADVISED OF THE POSSIBILITY OF SUCH DAMAGES.

Appendix D ♦ Glossary

601 An international standard (ITU-R BT.601) for component digital television. It defines the sampling systems, matrix values, and filter characteristics for digital television.

8 VSB Vestigial sideband modulation with 8 discrete amplitude levels.

16 VSB Vestigial sideband modulation with 16 discrete amplitude levels.

Advanced Television Systems Committee (ATSC) The parent organization that developed, tested and described the form and function of the US digital television formats.

AES/EBU A digital audio standard established jointly by the Audio Engineering Society (AES) and the European Broadcasting Union (EBU).

Artifacts Unwanted visible effects in the picture created by disturbances in the transmission or image processing, such as edge crawl or ‘hanging dots’ in analog pictures or ‘pixelation’ in digital pictures.

Aspect Ratio The ratio of horizontal to vertical dimensions. A square has an aspect of 1:1 since the horizontal and vertical measurements are always equal. Current television screen aspect ratios are 4:3 and 16:9.

Asynchronous Serial Interface (ASI) A transmission method adopted by the DVB, and called DVB-ASI. The transmission method allows for the transport of varying data payloads in a constant data stream. The DVB-ASI transport stream rate is 270 Mb/s.

Audio Breakaway Routing video and accompanying audio in separate signal paths.

Audio-Follow Routing video and accompanying audio together in the same signal path.

Auto Trans Automatic transition. The execution of a single wipe or fade from current picture to another picture by way of an automatic device.

Active Format Description (AFD) An ancillary data packet in a digital video interface for the purpose of describing certain spatial characteristics of a high definition or standard definition video image. Formatted according to SMPTE 2016, AFD information is intended to guide video equipment regarding the presentation of video of one aspect ratio on a display of another aspect ratio. Bar Data information is used to signal the precise unused areas of active video when the active image does not completely fill the picture area, in particular widescreen cinema material carried letterboxed in a frame with bars top and bottom

Bandwidth The range of frequencies used to transmit information such as picture and sound.

Baseband Video An unmodulated video signal.

Black Also color black, blackburst. A composite color video signal that has the composite sync, reference burst, and a black video signal.

Blanking Processor A circuit which removes sync, burst and blanking from the program video and then replaces it with sync, burst and blanking from the reference input. The process ensures constant sync and burst levels on program video.

Booga Good to view in order to see.

Border An electronically-generated picture member; used in wipes to separate the two video sources used in the wipe. It is of even thickness and has color produced by the matte generator.

Broadcast Legal Encoding video signal parameters to conform to prescribed limits for broadcast. Encoding rules vary by NTSC, PAL, country and broadcast facility.

BTSC Broadcast Television Standards Committee. A US standard for stereo audio encoding in NTSC broadcast television.

CAV Component Analog Video

CES Consecutive Errored Samples

Composite Video A single video signal that includes all color video and timing information. A composite signal includes luminance, chrominance, blanking pulses, sync pulses and color burst information.

Chrominance The color portion of a video signal that represents the saturation and hue. Black, gray and white have no chrominance; color signals have both chrominance and luminance.

CH Chroma

Chrominance/Luminance Delay (C/L Delay) A measurement that indicates the amount to which chrominance and luminance are aligned with respect to each other. A low C/L delay figure can minimize the effects of ghosts or color offset on the received picture.

Clipping The electronic process of shearing off the peaks of either the white or black excursions of a video signal for limiting purposes. Clipping is often performed prior to modulation to limit the signal.

CMRR Common Mode Rejection Ratio

Color Burst The portion of a color video signal which contains a short sample of the color subcarrier. It is used as a color synchronization signal to establish a reference for the color information following it and is used by a color monitor to decode the color portion of a video signal. The color burst acts as both amplitude and phase reference for color hue and intensity. The color oscillator of a color television receiver is phase locked to the color burst.

Composite Sync A signal consisting of horizontal sync pulses, vertical sync pulses and equalizing pulses only.

CRC Cyclical Redundancy Check

Crosspoint An electronic switch, usually controlled by a button on the panel. Control logic will allow for only one crosspoint, for each bus, to be switched “ON” on at a time.

D/A Conversion of digital to analog signals.

DA Distribution Amplifier

Data Element An item of data as represented before encoding and after decoding.

Decoded Stream The decoded reconstruction of a compressed bit stream.

Decibel (dB) A logarithmic measure of the ratio between two powers, voltages, currents, sound intensities, and so forth. Signal-to-noise ratios are expressed in decibels.

Default A factory preset value or condition.

Demodulator A receiver, such as for television broadcast, cable, and closed circuit applications. A TV demodulator receives and processes off-air or cable RF signals and provides baseband video and audio outputs.

DHCP Dynamic Host Configuration Protocol

Differential Gain A measurement that specifies how much the chrominance gain is affected by the luminance level. Expressed as a percentage showing the largest amplitude change between any two levels, it indicates how much color saturation variance occurs when the luminance level changes.

Differential Phase A peak-to-peak measurement that specifies the extent to which the chrominance phase is affected by the luminance level. Expressed in degrees of subcarrier phase, it indicates how much hue shift occurs with luminance level changes.

Digital Video Broadcasting (DVB) A specific project office of the European Broadcast Union. This group has produced a set of digital broadcasting standards.

DSK Down Stream Key, a keyer which is electronically located after (or down stream from) all other functions of a switcher. The key resulting will appear to be on top of all other pictures from the switcher.

D-VITC Digital Vertical Interval Time Code. Timecode information stored on specific lines in the vertical blanking interval of a television signal.

Display In the CMN-41, the output at the Front LCD or XGA/DVI connector.

EAV End of Active Video in component digital systems.

EBU European Broadcasting Union

Editor A device or system which controls video tape recorders, video switchers, and other related devices in order to electronically splice segments of recorded video into a finished production.

EDH Error Detection and Handling. A recommended practice defined in SMPTE RP 165. A system to generate and then detect video data errors in serial digital video systems.

Effects Keyer A keyer which is electronically located in the mix/wipe generator portion of a switcher. The resulting key would appear under the down stream key.

EIA Rack Space or Unit A specific size as designated by the Electronics Industry Association. The rack unit is 19 inches wide and is 1.75 inches tall. A device which requires 3 EIA rack units is 19 inches wide and 5.25 inches ($3 \times 1.75 = 5.25$) tall.

Elementary Stream (ES) A generic term for one of the coded video, audio or other variable length bit streams which are packetized to form MPEG-2 transport streams. Consists of compressed data from a single source (audio, video, data, and so forth). One elementary stream is carried in a sequence of PES packets with one and only one stream ID.

Embedded Audio Digital audio information multiplexed onto a serial digital data stream. Up to sixteen channels can be multiplexed on a single stream of digital video, minimizing cabling and routing requirement.

ENG Electronic News Gathering

Encoded Clip Softness In the encoded legalization process, “softness,” as applied to encoded clips, refers to the processing of the video at the point of the clip. The clips are applied in YCBCR color space. The clip point is either an immediate limit (no softness) or will have a range of values leading to the clip point, all reduced to smooth the clip point to a less immediate limit (softness).

Encoded Legalization Limiting of the luminance and color difference signals such that, once encoded into a composite video signal, the resultant encoded video does not violate the maximum or minimum signal levels as defined by the specific encoding rules. NTSC and PAL video plus various users of these types of video have many varied rules for maximum and minimum encoding limits. Encoded legalization usually calculates first the encoded luminance value and then the corresponding chroma value to make legalization judgments.

Encoded Video A combined single video signal that is constructed from either separate RGB or luminance and two color difference video signals. NTSC, PAL, and SECAM are all examples of encoded video.

Envelope Detection An RF signal detection technique that does not respond to phase variations in the carrier signal, enabling measurement of a transmitter’s incidental phase. When used together with synchronous detection, envelope detection helps isolate either video and/or RF as the causes of phase distortion.

External Key Input This is an alternate source for key cut. This is usually a separate external input to a switcher

Fade-thru-Black A production technique which is a two step process. The first step will fade the program video to black. The second step will fade from black to the video selected on the preview bus. This is usually used in major scene transitions.

Fade-to-Black A production technique which simply fades the program video to black and program audio to silent. This is used to end programs and to escape from embarrassing pictures or sounds.

Field A picture or picture portion which is produced within one cycle of vertical synchronization. In interlaced systems, a full picture or frame requires two consecutive fields.

FM Trap A circuit designed to minimize potential interference from strong FM signals in receiving equipment, such as a TV demodulator. For example, an FM trap can attenuate signals between 88-108 MHz to reduce interference on NTSC television channel 6.

Frame A single full resolution picture as viewed in either a video or film system. In the case of interlaced video, two consecutive fields provide all of the information of one frame. In non-interlaced systems, one cycle of vertical synchronization produces a frame. A 60 Hz interlaced system, produces 30 frames of video in one second. A 60 Hz progressive (or non-interlaced) system, produces 60 frames of video in one second. Common frame rates are 24 (film) 25, 29.97, 30, 50, 59.94 and 60.

Frame Synchronizer An electronic device that synchronizes two or more video signals. Using one input as a reference, it locks a second signal to the reference.

Frame Store An electronic method of capturing and storing a single frame of video.

Full A full-screen display of the selected pane (non quad or multi display).

Gamma This term applies to the linearity of the change from black to white. Gamma controls adjust the gray or 50% point of the video either up or down, with the effect of changing the gray level of the video.

Gamut The whole or total of whatever is being addressed. In color space, gamut refers to all colors which are included in a particularly defined color group, such as 601 gamut.

Genlock (Generator Lock) A method of synchronization involving the generation of a video signal that is time and phase locked with another signal.

GPI General Purpose Interface

Headend In a cable TV system, the facilities where program sources (satellite, terrestrial, VTR, local) are received and remodulated for distribution through a cable plant.

High Definition Television (HDTV) High definition television has a resolution of approximately twice that of conventional television in both the horizontal (H) and vertical (V) dimensions and a picture aspect ratio (H to V) of 16:9.

High Level A range of allowed picture parameters defined by the MPEG-2 video coding specification which corresponds to high definition television.

HRC Harmonically-Related Carrier

Hue Color tint

ICPM Incidental Carrier Phase Modulation. A measurement of picture carrier phase distortion (affected by the video signal level) that occurs in the transmitter.

IP Internet Protocol

IRC Incrementally-Related Carrier

I.R.E. Refers to the Institute of Radio Engineers, and is used as a unit of measurement. In NTSC television, 1 volt of signal equals 140 IRE units.

ISP Internet Service Provider

Jitter A deformation of a signal affected by poor synchronization.

Key An effect in television where a selected portion of background video is removed and replaced with another video.

Key Cut In a key effect, this is the video which designates the portion of background video which is removed.

Key Fill In a key effect, this is the video which is used to replace the portion of background video which was removed. This may be the same video as the Key Cut video.

Key Invert In a key effect, this is an electronic action which reverses the polarity of the key cut signal. It makes black appear as white, and white appear as black.

Key Mask In a key effect, it uses a wipe pattern from the wipe pattern generator to restrict the key cut from removing video in a portion of the screen. This requires the use of the wipe pattern generator and the Mask/Preset Size controls.

Key Source Another term which is the same as key cut.

Legalization The modification of serial digital video to conform to analog color space rules, as required by users.

LCD Liquid Crystal Display

LED Light-Emitting Diode

LFE Low Frequency Effects

Lissajous A display of the amplitude and phase relationships between two input signals.

LS Left Surround

LTC Longitudinal Time Code, A SMPTE timecode standard usually recorded onto the linear audio track of a VTR.

Luminance The degree of brightness (black and white portion of the video signal) at any given point in the video image. A video signal is comprised of luminance, chrominance and sync. If luminance is high, the picture is bright and if low the picture is dark. Changing the chrominance does not affect the brightness of the picture.

Main Level A range of allowed picture parameters defined by the MPEG-2 video coding specification with maximum resolution equivalent to standard definition television.

Main Profile A subset of the syntax of the MPEG-2 video coding specification that is supported over a large range of applications. Applications include, MP@HL (Main profile at high level) and MP@ML (Main profile at main level).

Mask/Preset Size Uses the wipe pattern generator in the keyer portion of the effects generator. This is used to adjust the size of a preset pattern or for adjusting the size of a mask to block a portion of the key cut (source) from use in the keyer.

Matte Generator An internal generator which can make any color, is used for border color and may be used for key fill. It is identical to the Color Background Generator, but simply used in other areas of the switcher.

Mbps Megabits Per Second

mV Millivolts

M/E Mix/Effects System

MP@HL Main profile at high level

MP@ML Main profile at main level

MPEG Refers to standards developed by the ISO/IEC JTC1/SC29 WG11, Moving Picture Experts Group.

MPEG-2 Refers to ISO/IEC standards 13818-1 (Systems), 13818-2 (Video), 13818-3 (Audio), and 13818-4 (Compliance).

Multi In the CMN-41, contains preconfigured screens (for CMN-41 Classic, Custom Timing, and Waveform-Vector screens only)

Multi-Level Effects Applies to any effects generator which can do more than one effect at a time. Typically, a multi level switcher can produce a Key and a Background transition in the same effects generator at one time.

NTSC National Television Systems Committee, the color television system used in the United States, Canada, Mexico and Japan.

NVRAM Nonvolatile RAM

Packet Identifier (PID) A unique integer value used to associate elementary streams of a program in a single or multi-program transport stream.

Packet A packet consists of a header followed by a number of contiguous bytes from an elementary data stream. It is a layer in the system coding syntax.

Packetized Elementary Stream (PES) The data structure used to carry elementary stream data. The packets consist of a header followed by payload data, and a stream is a series of packets which form an elementary stream and have a single stream identification.

PAL Phase Alternation Line; the standard color television system in many European and other countries.

Passive Looping Video and audio signals routed through components, even if power is removed. Signals are not amplified or processed, maintaining transparency.

Payload Identifier see Video Payload ID.

Pedestal Level An offset used in a video system to separate the active video from the blanking level by maintaining the black level above the blanking level by a small amount.

Pixel A Picture cell or Picture element representing one sample of picture information, such as an individual sample of R, G, B, luminance or chrominance.

Preset Refers to establishing any condition prior to use on the Program output. This term is used in reference to wipe patterns and is often interchanged with Preview.

Preview The video output channel used to view the intended Program results prior to the execution of the next transition.

PRO Audio A transmitted audio channel for talent cueing via Interrupt Foldback (IFB) to ENG vans and remote applications. Some demodulators support PRO audio monitoring.

Program A transport stream combination of a video stream and one or more audio and data streams associated with that video stream. In analog terms, “Program” refers to the Base Band video and audio produced by the final output of a switcher.

Program Association Table (PAT) A list of all programs that are in the ATSC data stream.

Program Map Table (PMT) A listing of all elementary streams that comprise a complete (television) program.

Program Clock Reference (PCR) This is a time reference signal that is placed in MPEG streams for the purpose of time coordinating various data streams.

Program and System Information Protocol (PSIP) Information sent out as part of an ATSC transport stream which lists all of the video, audio, data and program information contained in the stream. This is the “TV guide” for a given stream.

Progressive Scanning Also non-interlaced. A system of video scanning where lines of a picture are transmitted consecutively, such as with VGA monitor displays.

Push-push Toggle Switch An electro-mechanical device which, when pushed, alternates the condition of the switch. Push once, it’s off, push again, it’s on.

Quadrature Output An output in a television demodulator used for measuring Incidental Carrier Phase Modulation (ICPM) in a transmitter.

QPSK Quadrature Phase Shift Keying, typically used by satellite downlinks.

QAM Quadrature Amplitude Modulation, the technique used by cable TV systems (64-QAM and 256-QAM) to remodulate signals for distribution in a cable plant.

Quad In the CMN-41, this term applies to a screen that contains four panes.

RGB Legalization Limiting of luminance and color difference video signals such that, once transcoded into RGB component video signals, the resultant video does not violate the maximum or minimum signal levels as defined by component video level rules. Typically, the maximum value for R, G, or B is 700 mV, and the absolute minimum value for any of these signals is 0 mV.

Reclocking The process of regenerating digital data with a clock recovered from the input data.

Resolution A measure of the finest detail that can be seen, or resolved, in a reproduced image.

RS Right Surround

RS-422 Recommended Standard number 422, an E.I.A. standard which describes a type of data interchange. Television products use this standard as its communication format between the electronics frame and editors, control panel and computers. An RS-422 line may be extended up to 1,000 feet (304m).

Sampling Process by which an analog signal is sampled to convert the analog signal to digital.

SAP Secondary Audio Program, used in television broadcast for second language broadcasting, simulcasting, and separate audio programming.

Saturation Color intensity

SAW Filter Surface Acoustic Wave filter

Segment Error Rate (SER) A calculated average of uncorrected transport stream packets vs. total packets as accumulated over a designated period of time.

Signal to Noise Ratio -Analog (SNR) A measurement of the noise level in a signal expressed in dB (decibels) as a ratio of between the audio or video signal's maximum peak-to-peak signal voltage and the measured voltage of noise present when the signal is removed. Higher SNR figures indicate that any noise introduced by system components will not be perceived in the picture and sound output signals.

Signal to Noise Ratio-8VSB (SNR) As applies to 8VSB transmissions, this is a calculated average power of the ideal signal divided by the actual demodulated signal power.

SMPTE Society of Motion Picture and Television Engineers

Standard Definition Television (SDTV) This term is used to signify a digital television system in which the quality is approximately equivalent to that of NTSC. This equivalent quality may be achieved from pictures originated at the 4:2:2 level of ITU-R BT.601 and subjected to processing as part of the bit rate compression. The results should be such that when judged across a representative sample of program material, subjective equivalence with NTSC is achieved. The displayed picture may be either the traditional 4:3 or the wide-screen 16:9 aspect ratio.

STL Studio Transmitter Link

Synchronous Detection A common detection technique used in television demodulators that removes quadrature distortion, enabling comparison of transmitter output with video input signal.

S-Video Also Y/C. Transmits luminance and color portions separately via multiple wires, thus avoiding the color encoding process and resulting loss of picture quality.

Tally A system used to light lamps and indicate usage. Most production switchers have an internal tally system to indicate selected functions, and which selected functions are currently involved with Program.

TCP Transmission Control Protocol

Telecine A device used to convert film to video; movie film is digitally sampled and converted to video frame by frame in real-time.

TCXO Temperature Compensated Crystal Oscillator

THD Total Harmonic Distortion

Transport Stream-ATSC (TS) Consists of the following: (1) Packets: 188 bytes - fixed length with descriptive data, (2) Carries several programs, (3) has a PID which identifies the type of TS packet (video, audio, other), and (4) carries descriptive information about the program.

UHF Ultra High Frequency

Unity Gain An electronic term indicating that a signal will be neither amplified or attenuated. One volt of signal level in results in one volt of signal level out.

Vector A measure that has two individual properties: magnitude and direction.

Vector Clip A special encoded clip version that limits only the CB and CR input video signals and does not affect (nor is it affected by) the luminance component. This color-only clip limits the maximum vector excursions as viewed in an encoded state and is intended for users who wish to prevent encoded vectors from ever exceeding the perimeter circle of an encoded vector display.

VHF Very High Frequency

VITC Vertical Interval Time Code, a method for recording on to video tape the timecode address for each video frame inserted in the vertical interval.

Video Payload ID An ancillary data packet in a digital video interface for the purpose of identifying the video payload. Formatted according to SMPTE 352M the data includes the video format and interface transport, the picture rate and the picture and transport scanning methods, the sampling structure, and extended aspects of the video payload providing information about the channel assignment, dynamic range and bit-depth of the video payload.

Waveform A visual representation of a signal in the shape of a wave that plots amplitude versus time.

White Level The brightest part of a video signal, corresponding to approximately 1.0 Volt.

White Balance An electronic process used to calibrate the picture for accurate color display in different lighting conditions.

Wipe A special effect in which two pictures from different video sources are displayed on one screen. Production switchers and special effects generators provide numerous wipe patterns varying from simple horizontal and vertical wipes to multi-shaped, multi-colored arrangements.

XGA High resolution 1024×768 non-interlaced (progressive) display monitor

XVGA Extended Video Graphics Adapter

YPbPr: CAV format composed of luminance (Y) and two color difference signals (Pb and Pr)

Y/C Also S-video. Describes the separation of video signal luminance and chrominance components.

Zero Carrier Pulse (chopper) In a TV demodulator, removes the carrier in the vertical interval for a short period, enabling depth of field measurement.

This page is intentionally blank.

Index

A

- About display screen, 86
- Accessories
 - optional, 108
 - standard, 108
- Alarms
 - audio, 57
 - display, 54
 - duration, 89
 - GPI, 57
 - log, 54
 - log, 97
 - sensitivity, 89
 - setting, 89
 - setup menu, 82, 89
 - status, 56, 98
 - time code, 57
 - video, 57
- Amplification
 - horizontal, 29
 - vertical, 29
- Amplitude limits, 25
- Aspect ratio, 45
- Audio
 - alarms, 57, 92, 96
 - mapping, 54, 74
 - mapping, 65
 - setup, 54
 - setup menu, 68, 80, 92, 96
 - zoom, 54
- Audio display, 47, 48
- Audio scales, 48

B

- Back panel, 5, 10

C

- Capture
 - clearing
 - data, 24
 - displays, 23
 - data, 23
 - displays, 22
 - recalling
 - data, 24
 - displays, 23
 - storing
 - data, 23
 - displays, 23
- CES, 89
- Clear setup menu, 71, 83

- Clearing
 - data, 24
 - displays, 23
- Communication interfaces, 107
- Compliances, vii
- Composite gamut, 41
- Connectors, back panel, 10
- Control
 - external, 99
 - specifications, 105
- Controls
 - front panel, 16
 - types, 15
- Copyright information, 113
- Critical amplitude limits, 25
- Cursor
 - vector, 38
 - waveform, 31
- Customer Service, 6

D

- Data
 - capturing, 23
 - clearing, 24
 - recalling, 24
 - storing, 23
- Description, 1
- Directives, vii
- Display options
 - gamut, 44
 - vector, 38
- Display selections
 - full screen, 18
 - overlay, 20
- Display, capturing, 22
- Displays
 - audio, 47, 48
 - clearing, 23
 - gamut, 39
 - option, 60
 - picture, 44
 - PIP, 46
 - presets, 62
 - recalling, 23
 - specifications, 105
 - external reference, 106
 - LTC, 106
 - waveform, 106
 - storing, 23
 - timing, 57
 - vector, 32
 - waveform, 25
- DRT-4 rackmount, 8
- D-Sub connector pinouts, 110

E

- Environmental specifications, 108
- Ethernet
 - Addresses, 11
 - CAT5 Crossover Cable, 11, 12
 - Conforming to Industry Standards, 85
 - connector pinouts, 110
 - Dedicated Connection, 11
 - Network Connection, 12
 - Recording Addresses, 11
 - setup, 11
- Ethernet specifications, 107
- Export setup menu, 71, 82
- External control, 99
- External reference, 21
 - display specifications, 106
 - formats supported, 59
 - specifications, 104

F

- Features
 - optional, 2
 - standard, 1
- File Navigator dialog box, 87
- Formats
 - external reference, 59
 - SDI input, 59
 - selecting, 75
 - video, 2
 - critical amplitude limits, 25
 - unit of measure, 25
- Front panel, 5, 16
- Full screen display, 18
- Function selection, 21

G

- Gain
 - vector, 37
 - waveform, 29
- Gamut
 - composite, 41
 - display, 39
 - component, 43
 - specifications, 106
 - display options, 44
 - line select, 44
 - RGB, 42
 - setup menu, 44, 67, 78
- Gateway, 11
- Glossary, 133
- GPI
 - alarms, 57, 94, 97
 - connector pinouts, 110
 - setup menu, 94
 - setup menu alarms, 97

I

- Icons, 21
- Import setup menu, 71, 82
- Input selection, 18
- Input specifications, 103, 104
- Installation
 - checking contents, 7
 - DRC-3, 9
- Internal reference, 21

L

- Line select
 - gamut, 44
 - picture, 46
 - vector, 38
 - waveform, 30
- LTC
 - connector pinouts, 110
 - display specifications, 106

M

- Magnification specifications, 107
- Main title bar, 21
- Mechanical specifications, 107
- MLT. *See* Overlay display
- Moving
 - PIPs, 47
 - waveform, 28, 60

N

- Navigation, 22

O

- Operator's safety summary, iii
- Option (OPT) setup menu, 70
- Option displays, 60
- Optional accessories, 108
- Optional features, 2
- Output specifications, 104, 105
- Overlay display
 - description, 20
 - setup menu, 71, 82

P

- Panels
 - back panel, 5
 - front panel, 5
- Picture
 - aspect ratio, 45
 - display, 44
 - line select, 46
 - setup menu, 46, 67, 78

- Pinouts
 - Ethernet connector, 110
 - GPI connectors, 110
 - LTC connectors, 110
 - Power connector, 111
 - Remote RJ-11 Control Connector, 110
 - USB connector, 110
 - PIP
 - display, 46
 - moving, 47
 - removing, 47
 - scaling, 47
 - Power connector pinouts, 111
 - Power Requirements
 - specifications, 107
 - Presets, 62
 - recalling, 62
 - selecting, 62
 - storing, 62
 - Product description, 1
- ## R
- RA. *See* Return Authorization
 - Rackmount
 - DRT-4, 8
 - Recalling
 - data, 24
 - displays, 23
 - presets, 62
 - Reference, 58
 - Reference selection, 21
 - Removing
 - PIPs, 47
 - Return Authorization, 6
 - RGB
 - gamut display, 42
- ## S
- Safety, iii
 - Scaling PIPs, 47
 - SDI freeze specifications, 106
 - SDI input formats supported, 59
 - Selecting
 - components
 - waveform, 30
 - display options
 - waveform, 30
 - functions, 21
 - inputs, 18
 - presets, 62
 - references, 21
 - sweep modes, 28
 - Service, 6
 - Setting alarms, 89
 - Setup, 89, 92, 93, 94, 96, 97
 - Setup menu
 - accessing, 22, 63
 - alarms, 82
 - audio, 68, 80
 - audio mapping, 65, 74
 - clear, 71, 83
 - export, 71, 82
 - gamut, 44, 67, 78
 - import, 71, 82
 - navigating, 22, 63
 - option, 70
 - overlay display, 71, 82
 - picture, 46, 67, 78
 - time code source, 66, 75
 - timing, 60, 70, 81
 - unit configuration display, 71, 83
 - vector, 39, 67, 77
 - video, 65, 73
 - waveform, 32, 66, 75
 - Shipments, returning to Harris Corporation, 6
 - Sleep mode, 18
 - Specifications
 - 3 Gb/s-SDI, 103, 104
 - communication interfaces, 107
 - control, 105
 - digital audio, 104
 - displays, 105
 - environmental, 108
 - Ethernet, 107
 - external reference, 104
 - gamut display, 106
 - HD-SDI, 103, 104
 - input
 - 3 Gb/s-SDI, 103
 - digital audio, 104
 - HD-SDI, 103
 - SD-SDI, 103
 - magnification, 107
 - mechanical, 107
 - output
 - 3-Gb/s SDI, 104
 - analog monitoring, 105
 - DVI, 105
 - HD-SDI, 104
 - SD-SDI, 104
 - power requirements, 107
 - SDI freeze, 106
 - SD-SDI, 103, 104
 - time code, 106
 - Standard accessories, 108
 - Standard features, 1
 - Status bar, 21
 - Storing
 - data, 23
 - displays, 23
 - presets, 62
 - Sweep modes, 28

T

- Terms, 15
- Time code
 - alarms, 57, 93, 97
 - setup menu, 93, 97
 - specifications, 106
- Time code source
 - setup menu, 66, 75
- Timing
 - display, 57
 - setup menu, 60, 70, 81
- Title bar, 21
- Troubleshooting
 - initial checks, 101
 - problems, 101
 - restarting unit, 101

U

- Unit configuration display
 - setup menu, 71, 83
- Unit of measure, video format, 25
- USB connector pinouts, 110

V

- Vector
 - cursor, 38
 - display, 32
 - display options, 38

- gain, 37
- line select, 38
- setup menu, 39, 67, 77
- Video
 - alarms, 57, 89, 94
 - setup menu, 65, 73, 89, 94
- Video formats supported, 2

W

- Waveform
 - amplification
 - horizontal, 29
 - vertical, 29
 - cursor, 31
 - display, 25
 - display specifications, 106
 - gain, 29
 - graticules, 27
 - line select mode, 30
 - moving, 28, 60
 - selecting
 - components, 30
 - display options, 30
 - setup menu, 32, 66, 75
 - sweep modes, 28
- Web remote display, 99

Z

- Zoom, audio, 54

